

This area cut out  
to form a window



USER'S HANDBOOK

**Model 395**

100 MHz Synthesized

Arbitrary Waveform Generator

# USER'S HANDBOOK

for

## THE MODEL 395

### 100MHz Synthesized Arbitrary Waveform Generator

Part no. 850325

Issue 1.0 (April 2000)



For any assistance contact your nearest Wavetek-Datron Sales and Service Center. Addresses can be found at the back of this handbook.

© 2000 Fluke Precision Measurement Ltd.

**WAVETEK datron** is a registered trademark of Fluke Precision Measurement Ltd.

## WARRANTY

Wavetek-Datron warrants that all products manufactured by Wavetek-Datron conform to published Wavetek-Datron specifications and are free from defects in materials and workmanship for a period of one (1) year from the date of delivery when used under normal operating conditions and within the service conditions for which they were furnished.

The obligation of Wavetek-Datron arising from a Warranty claim shall be limited to repairing, or at its option, replacing without charge, any product which in Wavetek-Datron's sole opinion proves to be defective within the scope of the Warranty. In the event Wavetek-Datron is not able to modify, repair or replace non-conforming defective parts or components to a condition as warranted within a reasonable time after receipt thereof, Buyers shall be credited for their value at the original purchase price.

Wavetek-Datron must be notified in writing of the defect or nonconformity within the Warranty period and the affected product returned to Wavetek-Datron's factory or to an authorized service center within thirty (30) days after discovery of such defect or nonconformity.

For product warranties requiring return to Wavetek-Datron, products must be returned to a service facility designated by Wavetek-Datron. Buyer shall prepay shipping charges, taxes, duties and insurance for products returned to Wavetek-Datron for warranty service. Except for products returned to Buyer from another country, Wavetek-Datron shall pay for return of products to Buyer.

Wavetek-Datron shall have no responsibility hereunder for any defect or damage caused by improper storage, improper installation, unauthorized modification, misuse, neglect, inadequate maintenance, accident or for any product which has been repaired or altered by anyone other than Wavetek-Datron or its authorized representative and not in accordance with instructions furnished by Wavetek-Datron.

### **Exclusion of Other Warranties**

**The Warranty described above is Buyer's sole and exclusive remedy and no other warranty, whether written or oral, is expressed or implied. Wavetek-Datron specifically disclaims the implied warranties of merchantability and fitness for a particular purpose. No statement, representation, agreement, or understanding, oral or written, made by an agent, distributor, representative, or employee of Wavetek-Datron, which is not contained in the foregoing Warranty will be binding upon Wavetek-Datron, unless made in writing and executed by an authorized Wavetek-Datron employee. Under no circumstances shall Wavetek-Datron be liable for any direct, indirect, special, incidental, or consequential damages, expenses, losses or delays (including loss of profits) based on contract, tort, or any other legal theory.**

## EC Declaration of Conformity

WE:

Wavetek-Datron  
Hurricane Way  
Norwich, NR6 6JB  
United Kingdom

Declare under sole responsibility that the

### **Model 395 100MHz Synthesized Arbitrary Waveform Generator**

meets the intent of Directive 89/336/EEC for Electromagnetic Compatibility and Low Voltage Directive 72/23/EEC for Product Safety. Compliance was demonstrated to the following specifications as listed in the Official Journal of the European Communities:

#### **EMC Directive 89/336/EEC (rev 91/263/EEC. 92/31/EEC. 93/68/EEC):**

EN 50081 - 1 Emissions:

EN 55011/22 Class A radiated and conducted emissions

EN 50082 - 1 Immunity:

IEC 801 - 2 Electrostatic discharge immunity

IEC 801 - 3 RF electromagnetic field immunity

IEC 801 - 4 Electrical fast transient / burst immunity

IEC 801 - 5 Power line surge immunity

#### **Low Voltage Directive 73/23/EEC (rev 93/68/EEC):**

EN 61010 - I Safety requirements for electrical equipment for measurement, control and laboratory use.

## **SAFETY ISSUES**

**READ THIS ENTIRE SECTION THOROUGHLY BEFORE ATTEMPTING TO INSTALL, OPERATE OR SERVICE THE MODEL 395 100MHz SYNTHESIZED ARBITRARY WAVEFORM GENERATOR** *ix*

## **Section 1 Introduction**

1.1 THE MODEL 395.....	1-1
1.2 ORGANIZATION OF THIS MANUAL.....	1-2

## **Section 2 Initial Preparation**

2.1 THIS SECTION.....	2-1
2.2 RECEIVING AND INSPECTING SHIPMENTS.....	2-1
2.3 RETURNING EQUIPMENT FOR REPAIR.....	2-1
2.4 PREPARATION FOR STORAGE OR SHIPMENT .....	2-2
2.5 LINE VOLTAGES AND FUSES .....	2-2
2.6 INITIAL TURN-ON .....	2-4
2.7 ERROR MESSAGES .....	2-5
2.8 FUNCTIONAL CHECKOUT .....	2-5
Continuous Mode Check.....	2-5
Sweep Mode Check .....	2-5
Gated Mode Check .....	2-5
Triggered Mode Check.....	2-6
2.9 OPERATOR MAINTENANCE .....	2-6
2.9.1 Routine Maintenance .....	2-6
2.9.2 Battery Replacement .....	2-7
2.10 RACK MOUNTING EARS .....	2-7
2.11 REMOTE SETUP .....	2-7
2.11.1 RS-232 .....	2-7
2.11.2 IEEE-488 (Option 001).....	2-10

## **Section 3 Introduction To The Model 395**

3.1 OVERVIEW OF THE MODEL 395 .....	3-1
Using the Model 395 .....	3-1
3.2 NAVIGATING THE SCREENS.....	3-1
3.2.1 Front Panel Keys and Screens .....	3-1
3.2.2 Softkeys .....	3-2
3.2.3 Extended Screens.....	3-2
3.2.4 Changing Numeric Values .....	3-3
3.2.5 Correcting Mistakes .....	3-4
3.3 ON-SCREEN HELP.....	3-4
3.4 ERROR MESSAGES .....	3-5
3.5 INITIAL SETUP.....	3-5
3.6 MODEL 395 AS A FUNCTION GENERATOR .....	3-6
Example 1. Setting Up the Function Generator .....	3-6
3.7 MODEL 395 AS AN ARBITRARY WAVEFORM GENERATOR.....	3-10
Example 2 Creating an Arbitrary Waveform Using Line Draw .....	3-11
Example 3 Generating the Arb Waveform.....	3-14
Example 4. Creating an Arb Waveform Using Waveform Insert .....	3-17
Example 5. Creating an Arbitrary Waveform Using Point Edit .....	3-19
3.8 THE MODEL 395 AS A WAVEFORM SEQUENCE GENERATOR.....	3-22
Example 6 Creating a Waveform Sequence .....	3-22
3.9 STORING AND RECALLING SETUPS.....	3-24
Example 7. Storing and Recalling an Instrument Setup .....	3-24
3.10 THE MODEL 395 AS A SWEEP GENERATOR .....	3-25
Example 8. Setting up the Sweep Generator.....	3-25

3.11 THE MODEL 395 AS A TRIGGER GENERATOR.....	3-27
Example 9 Setting up the Triggered Generator.....	3-27
3.12 THE MODEL 395 AS A PULSE GENERATOR .....	3-31
Example 10 Setting up the Pulse Waveform.....	3-31
Example 11 Setting up the Pulse Train Waveform .....	3-34
3.13 THE MODEL 395 AS A NOISE GENERATOR .....	3-43
Example 12 Setting up the Signal To Noise Waveform .....	3-43
3.14 THE MODEL 395 AS AN AMPLITUDE MODULATION SIGNAL	
SOURCE .....	3-46
Example 13 Setting Up Amplitude Modulation .....	3-46
3.15 THE MODEL 395 SUMMING INPUT .....	3-48
Example 14. Setting Up Summing Input .....	3-48

## Section 4 Front Panel Operation Reference

4.1 INTRODUCTION .....	4-1
4.2 FRONT PANEL.....	4-1
4.3 REAR PANEL .....	4-9
4.4 REFERENCE.....	4-11
4.4.1 Amplitude .....	4-11
4.4.2 AM In (amplitude modulation And SCM) .....	4-14
4.4.3 Arbitrary Waveforms .....	4-16
4.4.3.1 Introduction.....	4-16
4.4.3.2 Creating Waveforms.....	4-17
4.4.3.3 Create From Copy .....	4-18
4.4.3.4 Modifying Waveforms .....	4-19
4.4.4 Filter .....	4-29
4.4.4.1 Introduction.....	4-29
4.4.4.2 Mode.....	4-29
4.4.4.3 Filter.....	4-30
4.4.5 Frequency .....	4-30
4.4.5.1 Standard Waveform Frequency .....	4-30
4.4.5.2 Standard Waveform Period .....	4-30
4.4.5.3 Arbitrary Waveforms - Frequency / Period .....	4-31
4.4.5.4 Sequence - Frequency/Period.....	4-31
4.4.5.5 Pulse / Pulse Train Period .....	4-31
4.4.5.6 Noise Clock .....	4-31
4.4.6 MODE .....	4-32
4.4.7 OFFSET.....	4-34
4.4.8 REMOTE .....	4-35
4.4.9 RESET.....	4-36
4.4.10 SEQUENCE.....	4-37
4.4.11 SETUPS .....	4-40
4.4.12 STANDARD WAVEFORMS .....	4-41
4.4.12.1 Introduction.....	4-41
4.4.12.2 Sine.....	4-42
4.4.12.3 Square .....	4-42
4.4.12.4 Triangle.....	4-42
4.4.12.5 DC.....	4-42
4.4.12.6 Positive Ramp .....	4-43
4.4.12.7 Negative Ramp.....	4-43
4.4.12.8 Sin(x)/x.....	4-43
4.4.12.9 Positive Haversine.....	4-43
4.4.12.10 Negative Haversine .....	4-43
4.4.12.11 Pulse .....	4-43
4.4.12.12 Pulse Train.....	4-46
4.4.12.13 Digital Noise .....	4-51
4.4.12.14 Analog Noise (White Analog Noise) .....	4-52



4.4.12.15 Comb .....	4-55
4.4.12.16 Signal Plus Noise .....	4-57
4.4.12.17 Signal Plus Comb .....	4-60
4.4.12.18 AM / SCM .....	4-63
4.4.12.19 FM.....	4-65
4.4.12.20 Arb Waveforms .....	4-66
4.4.12.21 Sequence .....	4-66
4.4.13 Status .....	4-67
4.4.14 Sum in .....	4-68
4.4.15 Sweep .....	4-69
4.4.16 Sync Out .....	4-74
4.4.17 Trigger .....	4-76
4.4.18 Utility.....	4-77
4.4.19 Ref In / Ref Out .....	4-79

## Section 5 Remote Operation

5.1 INTRODUCTION .....	5-1
5.2 SCPI PRIMER .....	5-2
5.2.1 Parameters.....	5-3
5.2.2 Queries.....	5-4
5.2.3 SCPI Punctuation and Syntax.....	5-4
5.2.4 Condensed Rules:.....	5-4
5.2.5 Text Symbols .....	5-5
5.2.6 Example Command Tree .....	5-6
5.2.7 Example Command Table .....	5-8
5.2.8 Example Command Syntax Diagrams.....	5-8
5.3 REMOTE RS-232 SETUP .....	5-11
5.3.1 Hardware Setup .....	5-11
5.3.2 Instrument Setup.....	5-11
5.4 IEEE-488.1 (GPIB) SETUP .....	5-12
5.4.1 Hardware Setup .....	5-12
5.4.2 Instrument Setup.....	5-12
5.5 SCPI PROGRAMMING EXAMPLES.....	5-13
5.5.1 Model 395 As a Function Generator.....	5-14
Example 1. Setting Up the Function Generator .....	5-14
5.5.2 Model 395 as an Arbitrary Waveform Generator.....	5-15
Example 2 Creating an Arbitrary Waveform Using Line Draw .....	5-15
Example 3 Running the Arb Waveform .....	5-16
Example 4. Creating an Arb Waveform Using Waveform Insert .....	5-17
Example 5. Creating an Arbitrary Waveform Using Point Edit .....	5-17
5.5.3 The Model 395 as a Waveform Sequence Generator .....	5-19
Example 6 Creating a Waveform Sequence .....	5-19
5.5.4 Storing and Recalling Setups.....	5-20
Example 7. Storing and Recalling an Instrument Setup .....	5-20
5.5.5 The Model 395 As a Sweep Generator .....	5-20
Example 8. Setting up the Sweep Generator.....	5-20
5.5.6 The Model 395 as a Trigger Generator .....	5-21
Example 9 Setting up the Triggered Generator.....	5-21
5.5.7 The Model 395 as a Pulse Generator.....	5-22
Example 10 Setting up the Pulse Waveform.....	5-22
Example 11 Setting up the Pulse Train Waveform .....	5-22
5.5.8 The Model 395 as a Noise Generator.....	5-24
Example 12 Setting Up the Signal To Noise Waveform .....	5-24
5.5.9 The Model 395 as an Amplitude Modulation Signal Source.....	5-24
Example 13 Setting Up Amplitude Modulation .....	5-24
5.5.10 The Model 395 and its Summing Input .....	5-25
Example 14. Setting Up Summing Input .....	5-25

5.6 SCPI COMMANDS .....	5-27
5.6.1 ABORT .....	5-27
5.6.2 CALibration .....	5-27
5.6.3 DISPlAY.....	5-28
5.6.4 INITiate.....	5-29
5.6.5 MMEMory.....	5-29
5.6.6 OUTPut .....	5-31
5.6.7 RESet.....	5-32
5.6.8 [SOURce] .....	5-33
5.6.9 STATus .....	5-44
5.6.10 SYSTem.....	5-45
5.6.11 TEST .....	5-45
5.6.12 TRACe .....	5-46
5.5.12 TRIGger .....	5-48
5.7 IEEE 488.2 COMMON COMMANDS .....	5-50
5.8 HIGH SPEED BINARY WAVEFORM TRANSFER .....	5-51
5.9 RS-232-C PROGRAMMING.....	5-53
5.10 GPIB ERROR HANDLING AND STATUS REPORTING.....	5-53
5.11 RESUMING LOCAL OPERATION .....	5-58

<b>Appendix A</b>	Specifications
<b>Appendix B</b>	Menu - Quick Reference
<b>Appendix C</b>	SCPI Command - Quick Reference
<b>Appendix D</b>	Rack Ears Kit Installation
<b>Appendix E</b>	Information/Error Messages
<b>Appendix F</b>	DSO Upload
<b>Appendix G</b>	Performance Verification and Alignment Procedures

---

# SAFETY ISSUES

**READ THIS ENTIRE SECTION THOROUGHLY BEFORE ATTEMPTING TO INSTALL, OPERATE OR SERVICE THE MODEL 395**

## General Safety Summary

This instrument has been designed and tested in accordance with the British and European standard publication EN61010: 1993/A2: 1995, and has been supplied in a safe condition.

This manual contains information and warnings that must be observed to keep the instrument in a safe condition and ensure safe operation. Operation or service in conditions, or in a manner other than specified could compromise safety. For the correct and safe use of this instrument it is essential that both operating and service personnel follow generally accepted safety procedures in addition to the safety precautions specified.

To avoid injury or fire hazard the instrument should not be switched on if it is damaged or suspected faulty, and it should not be used under damp, wet, condensing, dusty or explosive gas conditions.

Whenever it is likely that safety-protection has been impaired, the instrument must be made inoperative and be secured against any unintended operation. Qualified maintenance or repair personnel should be informed. Safety-protection is likely to be impaired if, for, example the instrument shows visible damage or fails to operate normally.

## Explanation of safety related symbols and terms



### DANGER

Risk of Electric Shock

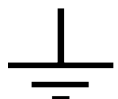
The product is marked with this symbol to indicate that hazardous voltage (> 30V dc or ac pk) may be present.



### CAUTION

Refer to accompanying documents

The product is marked with this symbol when it is necessary for the user to refer to the instruction manual.



Earth (Ground) Terminal

Functional Earth (Ground) only, must not be used as a Protective Earth.

### WARNING

Warning statements identify conditions or practices that could result in injury or loss of life

### CAUTION

Caution statements identify conditions or practices that could result in damage to this or other property.

### WARNING



**THIS INSTRUMENT CAN DELIVER A LETHAL ELECTRIC SHOCK. NEVER TOUCH ANY LEAD OR TERMINAL UNLESS YOU ARE ABSOLUTELY CERTAIN THAT NO DANGEROUS VOLTAGE IS PRESENT.**

---

## Protective Earth (or Grounding)

**Protection Class 1** - The instrument must be operated with a Protective Earth /Ground connected via the Protective Earth/Grounding conductor of the supply cable.

This is connected to the instrument before the line and neutral connections when the supply plug is inserted into the socket on the back of the instrument. If the final connection to the supply is made elsewhere, ensure that the ground connection is made before line and neutral.

**WARNING** Any interruption of the protective ground conductor inside or outside the instrument is likely to make the instrument dangerous. Intentional interruption is prohibited.



To avoid electric shock the signal connections to the instrument should be connected after the ground connection is made and disconnected before the ground connection is removed, i.e. the supply lead must be connected whenever signal leads are connected.

## Do Not Operate without Covers

To avoid electric shock or fire hazard, the instrument must not be operated with covers removed. The covers protect the user from live parts and unless otherwise stated they should be removed only by suitably qualified personnel for maintenance and repair purposes.

**WARNING** Removing the covers may expose voltages in excess of 1.5 kV pk; these may be present for up to one minute after the instrument has been disconnected from the power source; longer under fault conditions.



## Safe Operating Conditions

The unit must be operated only within the manufacturers specified operating conditions. Examples of specification that must be considered are:

- Ambient temperature
- Ambient humidity
- Power supply voltage and frequency
- Maximum terminal voltages or currents
- Altitude
- Ambient pollution level
- Exposure to shock and vibration

To avoid electric shock or fire hazard, do not apply to or subject the instrument to any condition that is outside specified range. Please refer to Appendix A of this manual for detailed Specification of the instrument and its operating conditions.

### CAUTION



Direct sunlight, radiators and other heat sources should be taken into account when assessing the ambient temperature.

### CAUTION



Before connecting the instrument to the supply, ensure that the rear panel AC supply voltage selector is set to the appropriate voltage, either 115V or 230V and that correctly rated fuses are fitted (see below)

## Fuse Requirements

To avoid fire hazard the fuse arrangement shown in the table below must be followed. Additionally the supply network must be fused at a maximum of 16 A and in the UK, a 5 A fuse should be fitted in the power cord plug.

## Power Input Fuse

Supply (Line) Voltage	Fuse Action	Fuse Rating UL/CSA	Wavetek-Datron Part No.	Manufacturer & Type No.
115 VAC	T Time delay	1 A	2400-05-0029	BUSSMAN MDL 1
230 VAC	T Time delay	500 mA	2400-05-0010	BUSSMAN MDL 1/2

## The Power Cord and Power Supply Disconnection

The power supply disconnect device is the ON / OFF switch on the *rear panel* of the instrument. The ON / OFF switch should be readily accessible whilst the instrument is in operation. If this operating condition cannot be satisfied, it is essential that either the power cord plug or a separate power disconnecting device be readily reached and accessible to the operator.

To avoid electric shock and fire hazard, ensure that the power cord is not damaged and is adequately rated against power supply network fusing. If the power plug is to be the accessible disconnecting device, the cord must not be longer than 3 metres.

## Connection to Instrument Terminals

Ensure that the instrument is correctly Earthed (Grounded) via its power cord before and whilst any other connection is made.

## Installation Category I

Measurement and/or guard terminals are designed for connection at Installation (Over voltage) Category I. To avoid electric shock or fire hazard the instrument terminals must not be connected directly to the mains power supply or any other source of voltage or current that might temporarily exceed the peak ratings of the instrument

**WARNING** To avoid injury or loss of life, do not connect or disconnect signal leads while they are connected, or suspected of being, connected to a hazardous voltage or current source (internal or external to the instrument).



## Maintenance and Repair

Local or national safety regulations and rules for the prevention of accidents and hazard must be observed in all work performed. The unit must be disconnected from all signal sources and then the power supply before the removal of covers. Any adjustment, parts replacement, maintenance or repair should be carried out only by authorised Wavetek-Datron technical personnel.

**WARNING** For continued protection against injury and fire hazard it is essential that only manufacturer supplied parts be used to replace parts relevant to safety. Safety tests must be performed after the replacement of parts relevant to safety.



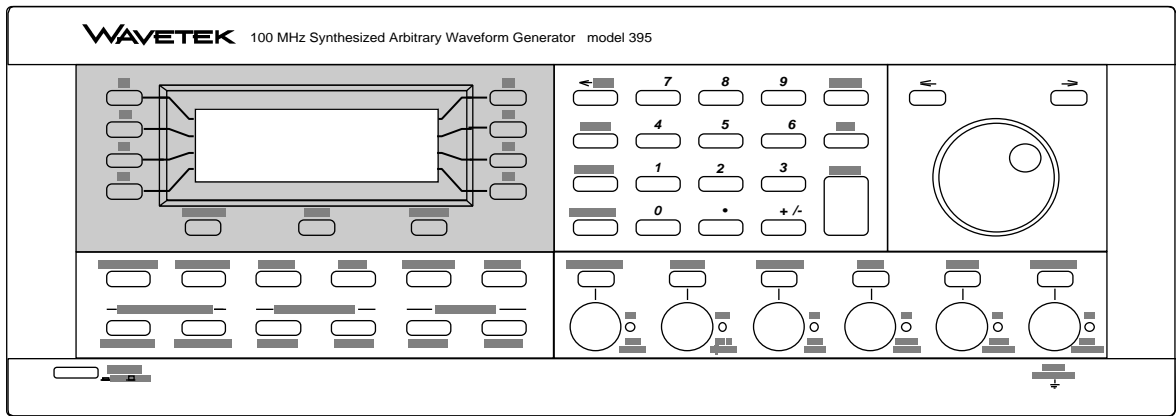
## Ventilation and Dust

The instrument relies on forced air cooling via a fan and ventilation slots. Adequate ventilation can usually be achieved by positioning on a level surface and by leaving a 75 mm (3" gap) around the instrument. Care should be taken to avoid restricting the airflow to or from the fan at the *rear/sides* of the instrument as damage may result from overheating.

## Cleaning

Ensure the instrument signal and then power leads are disconnected prior to cleaning. Use only a damp, lint free cloth to clean facia and case parts.

**Observe any additional safety instructions or warnings given in this manual.**



**Model 395, 100 MHz Synthesized Arbitrary Waveform Generator**

## 1.1 THE MODEL 395

Wavetek-Datron's Model 395 100-MHz synthesized arbitrary waveform generator delivers high-speed performance in both bench-top and ATE applications. The Model 395 combines the capabilities of a synthesized arbitrary waveform generator, synthesized function generator, pulse generator, noise generator, sweep generator, and trigger generator. As a modulation source, the Model 395 provides real-time AM and SCM, and synthesized AM, SCM and FM.

The Model 395's 1mHz to 100 MHz clock generates arbitrary (user-defined) waveforms with 12 bits of vertical resolution (4096 points: -2048 to +2047) and up to 256K points of horizontal memory for simulating "real-world" non-standard signals. At clock rates of 50 MHz or below, Model 395 uses direct digital synthesis (DDS) that provides high-frequency resolution (up to 10 digits). Model 395 is an excellent signal source for a wide range of applications, including in-circuit testing of semiconductors, communication testing requiring complex pulse patterns, and performance characterization testing of electrical devices.

Create arbitrary waveforms using the Model 395's front panel by using point-by-point, copy, or line edit modes. Also, use the RS-232 interface or optional GPIB (IEEE-488.2, SCPI compatible) interface to upload waveforms. Wavetek-Datron's WaveForm DSP software tool makes waveform creation, modification, and uploading easy over the GPIB interface. The Direct DSO Upload, part of Option 001 IEEE-488 Interface, allows transfer of waveforms captured with a digital storage oscilloscope directly into the Model 395.

Another capability, Sequence, allows up to four waveforms to be linked in a sequence with advancement from one waveform to the next conditional upon waveform repeat (loop) counts and trigger signals.

In addition to complex arbitrary waveforms, Model 395 provides a number of synthesized standard waveforms including sine waves to 40 MHz, square waves to 50 MHz, and triangle waves to 10 MHz.

The built-in pulse generator generates pulses with programmable parameters that include rate, width, delay, and rise/fall times. Pulse train allows you to create a series of up to 10 independently programmable pulses each with their own level, width, delay, rise/fall times.

Noise functions provide analog noise, digital noise, signal-plus-noise, comb, and comb-plus-noise.

Sweep allows frequency sweeps from 1mHz to 20 MHz in one continuous band and include seven sweep modes, as well as linear or logarithmic spacing.

The Model 395 allows real-time AM and SCM modulation of both standard and arbitrary waveforms.

For non-continuous operation, the Model 395 provides triggered and gated modes. Triggered mode includes programmable burst counts from 1 to 1,048,575 counts. Trigger sources include an internal trigger rate generator, manual trigger key, trigger input BNC, and remote trigger command.

Model 395 is designed to provide an MTBF in excess of 10,000 hours, thus the Model 395 is extremely reliable. The easy-to-use calibration procedure can be performed entirely from the front panel in less than fifteen minutes without removing the instrument cover.

---

## 1.2 ORGANIZATION OF THIS MANUAL

### Installation and Preparation For Use

Section 2 tells you how to set up and check out the Model 395 before you use it. It also familiarizes you with the physical setup of the unit.

### Introduction To The Model 395

Section 3 describes the fundamentals of front panel operation using a series of examples.

### Operation Reference

Section 4 provides detailed explanations for every function and feature of the Model 395.

### Remote Operation

Section 5 provides an introduction to the set up and operation of the Model 395 from remote sources using the standard RS-232 or optional IEEE-488.2 interfaces. It also contains the Model 395's SCPI remote command set and IEEE-488.2 Common Commands.

### Specifications

Appendix A, located at the rear of this manual, contains the detailed specifications for the Model 395.

### Menu Quick Reference

Appendix B contains quick reference diagrams of the Model 395's menu structure.

### SCPI Quick Reference

Appendix C contains quick reference diagrams of the Model 395's SCPI command tree. The SCPI information is presented as a "Primer". This appendix also contains the SCPI required Conformance Information.

### Rack Adapter Instructions

Appendix D contains instructions for mounting the Model 395 in an instrument rack.

### DSO Upload

Appendix F contains instructions on DSO uploading to the Model 395. Plus, appendix F describes how to create and load DSO driver files for DSOs not included in the unit's firmware.

### Verification and Alignment Procedures

Appendix G contains both the verification test procedure and alignment procedure for the Model 395.



## 2.1 THIS SECTION

This section contains:

Receiving and Inspecting Shipments;  
Returning Equipment For Repair;  
Preparation For Storage or Shipment;  
Preparation For Use;  
Initial Turn on;  
Functional Checkout;  
Routine Maintenance.

## 2.2 RECEIVING AND INSPECTING SHIPMENTS

Use the following steps to inspect a shipment of Wavetek-Datron equipment.

1. Inspect the shipment. If the shipment is damaged have the driver describe the box damage and list shortages on the delivery bill.  
  
If you find unreported shortages or damage, notify the shipper before further unpacking.
2. After unpacking the boxes. Save all of the packing material.
3. Inspect the equipment for damage. Inspect it carefully, regardless of the condition of the shipping boxes.
4. If necessary, file a damage claim. If any damage is found, call the shipper within 10 days and start the claim process.
5. Call Wavetek-Datron. Call Wavetek-Datron's Customer Service department and tell them that the equipment arrived damaged.

## 2.3 RETURNING EQUIPMENT FOR REPAIR

Use the following steps if you should ever need to return the Model 395 to Wavetek-Datron for repair.

1. *Save the packing material.* Always return the equipment to Wavetek-Datron in its original packing material and boxes. If you use inadequate packing material, you will have to pay to repair any shipping damage. Carriers will not pay claims on incorrectly packed equipment.
2. *Call Wavetek-Datron for a Return Authorization.* Wavetek-Datron's customer service representative will ask for the name of the person returning the equipment. Plus, the representative will ask for your telephone number, company name, equipment type and serial number, and a description of the problem.

---

## 2.4 PREPARATION FOR STORAGE, SHIPMENT OR OPERATION

### Packaging

If possible, always use the original shipping container. However, when using packing materials other than the original, use the following guidelines:

Wrap the Model 395 in plastic packing material.

Use a double-walled cardboard shipping container.

Protect all sides with shock absorbing material (minimum of 2 inch thick material) to prevent movement of the Model 395 within the container.

Seal the shipping container with approved sealing tape.

Mark "FRAGILE" on all sides, top, and bottom of the shipping container.

### Storage

The Model 395 should be stored in a clean, dry environment. In high humidity environments, protect the Model 395 from temperature variations that could cause internal condensation. The following environmental conditions apply to both shipping and storage;

Temperature	-20°C to +70°C
Relative Humidity (sea level)	Less than 95% at 11°C to +30°C.
Altitude	Less 15,000 feet (4570 meters).
Vibration	Less than 2g.
Shock	Less than 40g.

### Operation

The Model 395 should be operated on a flat surface or in an equipment rack within its environmental specifications. All air vents should be clear of obstructions.

Signal connections should not be made to external hazardous voltages.

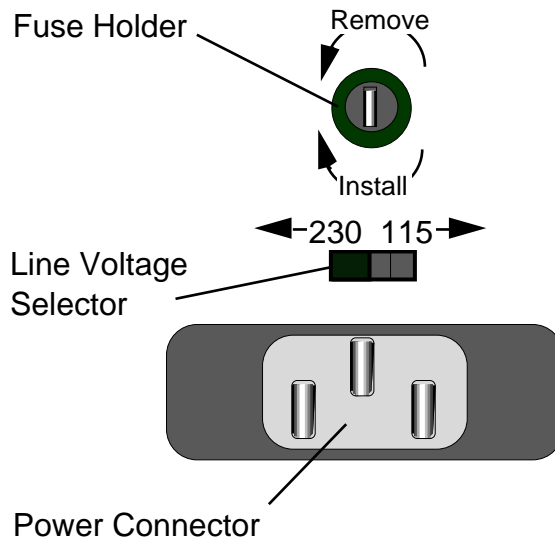
### WARNING



**THIS INSTRUMENT CAN DELIVER A LETHAL ELECTRIC SHOCK. NEVER TOUCH ANY LEAD OR TERMINAL UNLESS YOU ARE FIRST ABSOLUTELY CERTAIN THAT NO DANGEROUS VOLTAGE IS PRESENT. SEE THE SAFETY ISSUES SECTION AT THE FRONT OF THIS MANUAL.**

## 2.5 LINE VOLTAGES AND FUSES

The Model 395 accepts a primary input voltage of either 90 to 132 Vac or 198 to 252 Vac, 50/60 Hz. Wavetek-Datron ships the Model 395 set for the line voltage and with the proper fuse for the destination country. Figure 2-1 illustrates the location of the line voltage switch and fuse holder.



**Figure 2-1. Line Voltage Switch and Fuse Holder**

To change the line voltage, disconnect the power cord from the Model 395. Slide the Line Voltage Selector (figure 2-1) to the desired line voltage: left for 230VAC, and right for 115VAC. Refer to table 2-1 for voltage ranges for each voltage position. Also check that the fuse is the correct rating; see the following procedure.

To change the fuse, perform the following steps:

1. Disconnect the power cord from the instrument. Remove the fuse from the fuse holder.

**Table 2-1. Line Voltage and Fuse Selection**

Supply (Line) Voltage	Fuse Action	Fuse Rating UL/CSA	Wavetek-Datron Part No.	Manufacturer & Type No.
115 VAC	T Time delay	1 A	2400-05-0029	BUSSMAN MDL 1
230 VAC	T Time delay	500 mA	2400-05-0010	BUSSMAN MDL 1/2

2. Compare the ampere rating on the fuse to the ampere ratings given in table 2-1. If the fuse is blown, replace it by sliding the new fuse back into the fuse holder. If the fuse is not blown and has the right rating, keep it. If the fuse has the wrong rating, place the new fuse into the fuse holder.
3. Connect the ac line cord supplied to the power connector at the rear of the unit and power source.

**CAUTION**



IN THE EVENT OF FAILURE OF ANY FUSE, CONTACT THE SERVICE CENTER IMMEDIATELY. SEE THE SAFETY ISSUES SECTION AT THE FRONT OF THIS MANUAL.

## 2.6 INITIAL TURN-ON

### WARNING



The Model 395 is equipped with a three-wire power cable. When connected to a grounded AC power receptacle, this cable grounds the instrument. Do not use extension cords or AC adapters without a ground.

1. Connect the power cable supplied to the power connector on the Model 395 rear panel; see figure 2-2.

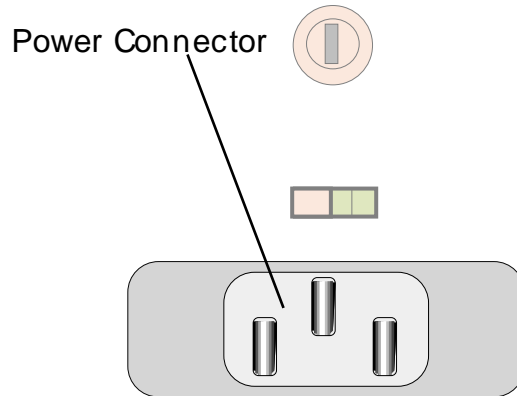


Figure 2-2. Power Connector

### WARNING



ANY INTERRUPTION OF THE PROTECTIVE EARTH/GROUND CONDUCTOR INSIDE OR OUTSIDE THE INSTRUMENT IS LIKELY TO MAKE THE INSTRUMENT DANGEROUS. SEE THE SAFETY ISSUES SECTION AT THE FRONT OF THIS MANUAL.

2. Press the "POWER" On/Off switch in to turn the unit on (figure 2-3).

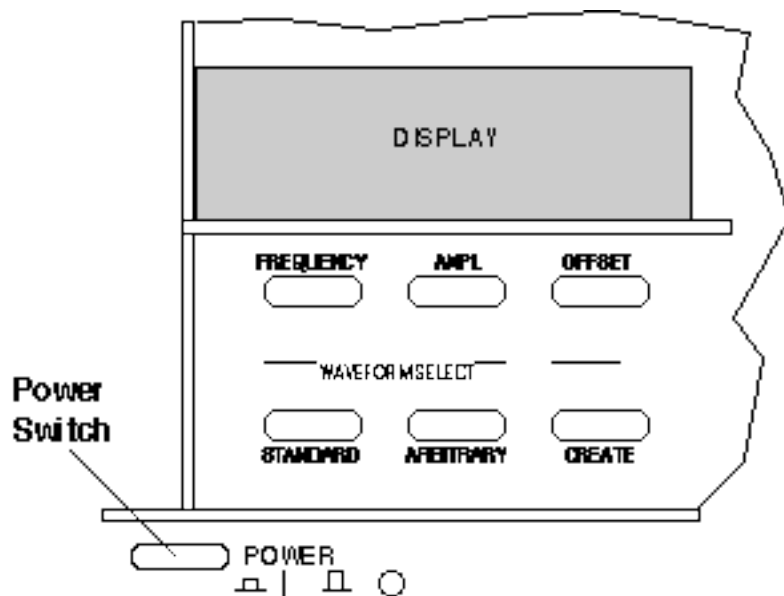


Figure 2-3. Power Switch

---

## 2.7 ERROR MESSAGES

Some front panel entries may cause error or information messages to appear on the display.

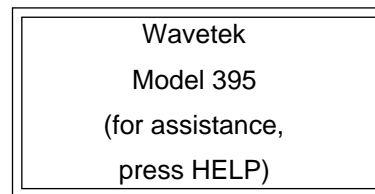
## 2.8 FUNCTIONAL CHECKOUT

The functional checkout provides a quick method of verifying the Model 395 operation. The only test equipment required is an oscilloscope (Tektronix 2445 - dual channel or equivalent), and the appropriate cables and loads.

### Continuous Mode Check

1. Connect the Model 395 to the primary power source. Leave all cables disconnected. See Initial Turn-On in this section.
2. Turn on the Model 395 by pushing in the POWER switch.

At power on, the Model 395 displays its start up screen (figure 2-4).



**Figure 2-4. Model 395 Start Up Screen**

3. Press the RESET key, and from the Instrument Reset screen press F3 to reset all parameters. Then press F8 to confirm reset.
4. Press the MAIN OUT key to turn on the Main Output. Main Out indicator remains on.
5. Press the SYNC OUT key. From the Sync Output Setup screen, press F2 twice to turn the Sync Output on ("output: on").

Observe: Scope displays a 1Vp sine wave at 1kHz (Main Out must be terminated into 50 Ω).

### Sweep Mode Check

Press the MODE key. From the Mode screen, press F2 "sweep."

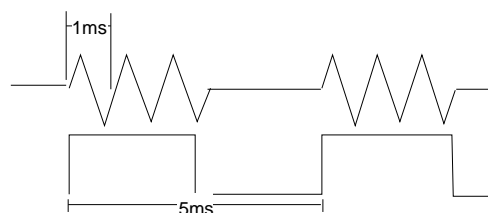
Observe: Scope displays a sweep of the frequency from 1kHz to 10 kHz.

### Gated Mode Check

Press the MODE key. From the Mode screen, press F3 "gated." Press the STANDARD key, and then rotate the knob; select the softkey to select "triangle."

This check uses the Model 395's internal trigger source which is programmed to 5 ms.

Observe: Scope displays a gated waveform; see below:



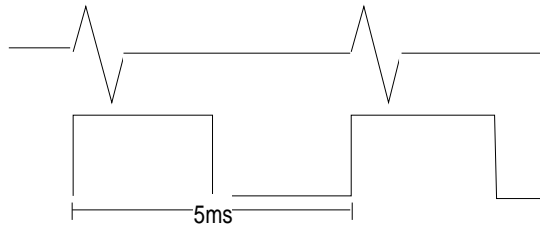
---

## Triggered Mode Check

Press the MODE key. From the Mode screen, press F4 “trig’d.”

This check uses the Model 395’s internal trigger source which is programmed to 5 ms.

Observe: Scope displays a triggered waveform with a count of 1; see below:



This completes the functional test. Remove all cables and test equipment.

## 2.9 OPERATOR MAINTENANCE

### 2.9.1 Routine Maintenance

No tools or equipment are required for routine maintenance. Cleaning materials required are listed below:

Description	National Stock Number
Cotton Cheesecloth	8305-00-267-3015 CCC-C-440, Type II, Class 2 (81349)
Mild Liquid Detergent	None

Routine maintenance for the Model 395 is limited to routine tasks such as listed below;

- Cleaning, using cloth moistened with detergent
- Dusting,
- Wiping,
- Checking for frayed cables,
- Storing items not in use,
- Covering unused receptacle,
- Checking for loose screws.

Perform these routine tasks as required.

---

## 2.9.2 Battery Replacement

The Model 395 contains an internal battery for the unit's internal memory. Its replacement should only be carried out by a suitably qualified technician. Measure the battery voltage when performing calibration of the unit (approximately every 12 months); refer to paragraph 4.3, figure 4-7 and table 4-6 item 6. The battery should measure between +3.2 Vdc and +2.7 Vdc. Replace the battery when it measures +2.7 Vdc or below to avoid losing Arb waveforms, stored settings, "last setup," and all remote setup parameters.

### WARNING



This instrument uses an internal battery containing more than 0.2 grams of Lithium. Do not charge or short this battery. A hazard of explosion and or contamination exists.

**CAUTION** Always replace the battery with one of the same type: Panasonic BR-2/3A



To replace the battery. This task should only be undertaken by a suitably qualified technician.

1. Turn off the Power and disconnect the power cable.
2. Remove the two screws; one on each side of the cover.
3. Slide the cover back.
4. Remove the battery.
5. Remember, removing the battery will loose Arb waveforms, stored settings, "last setup," and all remote setup parameters.
6. Install the new battery. Be sure to match the polarity on the battery with the polarity indicator on the battery holder.

## 2.10 RACK MOUNTING EARS

The Model 395 can be rack mounted using the optional mounting ears (Option 004). Installation instructions are in appendix D of this manual.

## 2.11 REMOTE SETUP

### 2.11.1 RS-232

To connect the Model 395 to a computer via RS-232, use the provided RS-232 cable. For information on RS-232 remote programming, refer to section 5 of this manual. Note that the 0 V connection on the RS-232 connector is internally connected to the floating analog common and not ground.

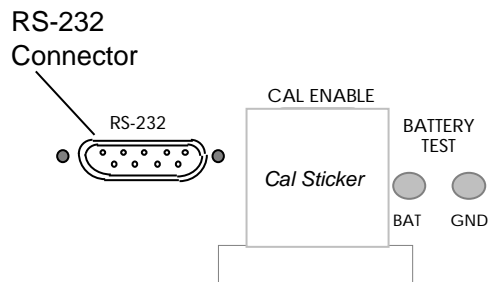


Figure 2-5. RS-232-C Connector

---

## Standard RS-232 Connection

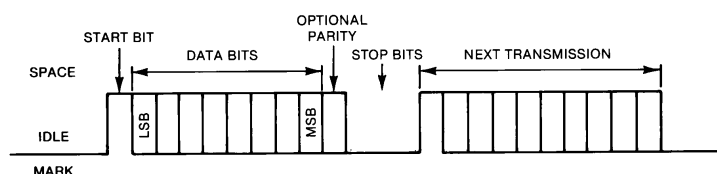
The Model 395 is configured as a DCE, and uses a 9-pin female connector (DB-9). The standard connection will be to a DTE (generally a computer) with a standard 9-pin male connector (DB-9). This connection can be made using the 9-pin female to 9-pin male cable (P/N 6001-00-0061) included with the Model 395. If the DTE uses a male DB-25, the connection can be made using the 25-pin female to 9-pin male adapter (P/N 2100-02-0328) included with the Model 395. After connections are made, both the Model 395 and the DTE must be configured to have the same baud rate and data format. The data format for the model 395 is 8-bits, no parity, one stop bit. Refer to section 5.3 for the Model 395 RS-232 setup.

## Non-Standard RS-232 Connection

Because the Model 395 is configured as a DCE, connection to a device configured other than a standard DTE may require a special cable. Some knowledge of the RS-232 is beneficial to insuring a proper connection. The pin assignments for the model 395 and for a standard DTE (an AT comm port), are given in Table 2-2.

EIA STANDARD RS-232-C specifies the electrical characteristics and pinouts of a serial communication standard for connecting "Data Terminal Equipment" (DTE) to "Data Communication Equipment" (DCE). A DTE is usually a device such as a terminal, computer, or printer, that is the final destination of data. A DCE is usually a device that converts data to another form and passes it through such as a modem. Because RS-232 signal lines defined as outputs on a DTE are inputs on a DCE and vice versa, connection of a DTE to a DTE or a DCE to a DCE requires a special cable with many of the lines interchanged. Generally a "Null Modem" cable will have the correct lines interchanged.

With RS-232-C, data is transferred serially between two devices using a voltage of +3 to +25 Vdc to represent a zero (space), and a voltage of -3 to -25 Vdc to represent a one (mark). Only two lines are required to transfer data, transmit and receive. When no data is being transferred, these lines will be at a mark state. To transmit a byte, the transmitting device first sends a start bit, a space, to synchronize the receiver. Then, the data bits are sent LSB first (eight bits for 395). Some devices follow the data bits with a parity bit (not 395). At the end there is up to 2 stop bits (395 uses one stop bit) that are at the mark state.



The rate at which the bits are transferred is called baud rate and is in bits per second. The baud rate must be set the same for both devices. The 395 has seven different baud rates ranging from 1200 to 57.6K.

Handshaking is a communication between the two devices to control the transfer of data to insure no data is lost when the data is transferring faster than a device can process it. Handshaking can be accomplished in two ways, software or hardware. Software handshaking is done using XON / XOFF protocol (not supported by 395), which sends control characters over the data lines to control the flow.



Hardware handshaking uses additional lines ( DSR, DTR, RTS, CTS) to signal when the device is ready to receive data. These handshake lines use +3 to +25 Vdc to indicate a true, and -3 to -25 to indicate a false condition. When a DTE is ready to communicate, it drives the DTR line true. The DCE (395) will respond by driving the DSR line true. Then the DTE will drive RTS true when it is ready to receive data and the DCE will drive CTS true when it is ready to receive data.

Table 2-2a. Model 395 RS-232 Connections (DB-9)

Pin	Name	Direction	Description
1	DCD	OUT	Carrier Detect
2	RxD	IN	Receive Data
3	TxD	OUT	Transmit Data
4	DTR	IN	Data Terminal Ready
5	GND	COMMON	Signal Ground
6	DSR	OUT	Data Set Ready
7	RTS	IN	Request To Send
8	CTS	OUT	Clear To Send
9	NC	- - -	No Connection

Table 2-2b. Standard DTE RS-232 Connections

Pin	Name	Direction	Description	
DB-9	DB-25			
1	8	DCD	IN	Carrier Detect
2	3	RxD	IN	Receive Data
3	2	TxD	OUT	Transmit Data
4	20	DTR	OUT	Data Terminal Ready
5	7	GND	COMMON	Signal Ground
6	6	DSR	IN	Data Set Ready
7	4	RTS	OUT	Request To Send
8	5	CTS	IN	Clear To Send
9	22	RI	IN	Ring Indicator

The Model 395 RS-232 signal names are defined below. A positive voltage above +3Vdc is defined as a logic '0' or 'ON'. A negative voltage below -3 Vdc is defined as a logic '1' or 'OFF'.

**DCD** Internally connected to pins 4 (DTR) and 6 (DSR) in the model 395. A logic '0' signifies that the 395 is ready for communication. See notes for DTR.

**TxD** Serial data output from Model 395.

**RxD** Serial data input to Model 395.

**DTR** Signal from a DTE that indicates it is ready for communication. This signal is internally connected to pins 1 (DCD) and 6 (DSR). Upon receipt of a logic '0', the DCD and DSR are driven to logic '0' thus signaling that the 395 is ready for communication.

**GND** Connected to internal signal ground. This should be connected to a ground point on the device that the 395 is going to communicate with for proper error free operation.

- DSR Internally connected to pins 1 (DCD) and 4 (DTR) in the model 395. A logic '0' signifies that the 395 is ready for communication. See notes for DTR.
- RTS A logic '0' on this pin indicates that the device that is connected to the 395 is ready to receive data. When handshaking is disabled, this line is ignored by the 395. The length of time that the 395 will wait before aborting transmission can be set in the RS-232 setup screen (see section 5). The Model 395 will respond to a logic '1' with a transmission latency of one character.
- CTS A logic '0' indicates that the Model 395 is ready to receive data. When handshaking is enabled, this line is driven to logic '1' when the 395 receive buffer is about 2/3 full. Data will continue to be stored in the buffer until it is full. This line will be driven to a logic '0' when the buffer drops below 2/3 full. To prevent data loss, this line should be connected and recognized by the other device.

**NOTES:**

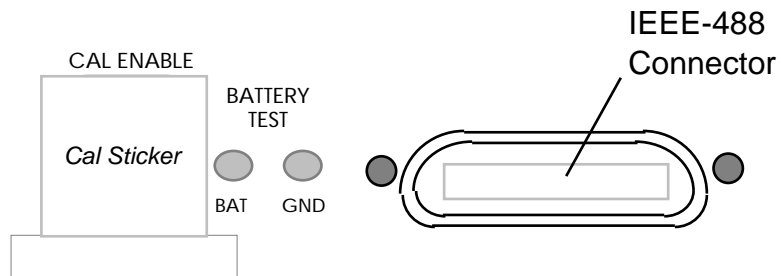
Although communication can be accomplished using only the Transmit and Receive lines, it is recommended that the ground and handshake lines are connected so no data is lost due to the high transfer rates possible with the Model 395.

Software handshaking ( XON / XOFF ) is not supported by the Model 395.

The Model 395 data format is 8 data bits, no parity, 1 stop bit.

**2.11.2 IEEE-488 (Option 001)**

To connect the Model 395 via the IEEE-488 interface to a computer or digital storage oscilloscope, DSO, (figure 2-6), use a standard IEEE-488 bus cable [Wavetek-Datron part number 630364 (1 metre) or 630366 (2 metres)]. For more information on remote programming using IEEE-488, refer to section 5 of this manual.



**Figure 2-6. IEEE-488 Connector**

Note that the 0 V connection on the IEEE-488 connector is internally connected to the floating analog common and not ground.

### **3.1 OVERVIEW OF THE MODEL 395**

The Model 395, 100 MHz Synthesized Arbitrary Waveform Generator, produces a variety of standard, pulse, noise, and user-defined (Arbitrary) waveforms. In addition, the Model 395 allows linking of up to four arbitrary waveforms to form a Sequence. Plus, the Model 395 triggers, sweeps, and modulates all waveforms. Also, sum an external signal with the generator's internal signal.

The Model 395 stores up to 100 Arbitrary waveforms in battery-backed memory. Complete instrument setups can be stored and recalled.

#### **Using the Model 395**

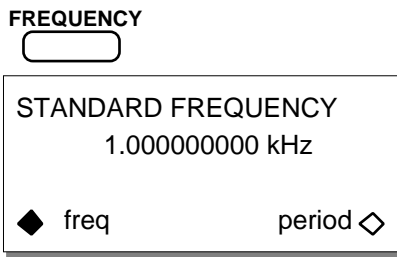
This section introduces front panel operation of the Model 395. Included in this section are a series of examples demonstrating the features of the unit. Section 4 contains reference information about Model 395 operation. Section 5 describes the SCPI remote programming commands, RS-232 operation, and optional IEEE 488 operation. Section 5 also contains a series of SCPI language remote programming examples demonstrating the unit's features; these examples are the remote programming equivalent of the examples in this section.

Appendix B of this manual contains a front panel screens quick reference, while appendix C contains SCPI commands quick reference.

### **3.2 NAVIGATING THE SCREENS**

#### **3.2.1 Front Panel Keys and Screens**

Pressing front panel keys display screens with program parameters relative to the key pressed. Change program parameters by using softkeys (F1 through F8), or change numeric values using the keypad or knob. For example, press the FREQUENCY key to display the Frequency screen; see figure 3-1.



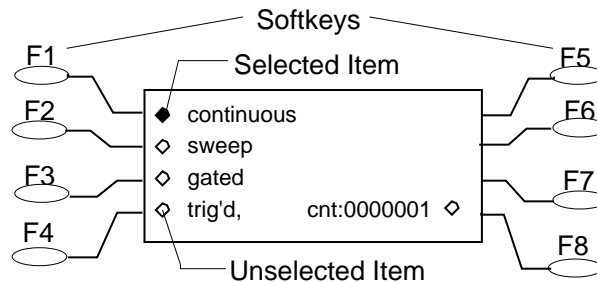
**Figure 3-1. Frequency Screen**

Try pressing the TRIG IN key or MODE key to display their screens.

### 3.2.2 Softkeys

The Model 395 front panel softkeys (F1 through F8) allow you to select items from the screen (figure 3-2).

Diamonds on the screen identify selectable screen items. Hollow diamonds identify deselected items. Filled diamonds denote selected items. For example, press MODE and then press F3 to select the “gated” mode (figure 3-2). Default items are initially displayed with filled-in diamonds (like continuous in figure 3-2).



**Figure 3-2. Softkeys (Mode Screen)**

### 3.2.3 Extended Screens

#### Double-Headed Arrows

Double-headed arrows on the screen indicate additional screen items can be accessed by using the knob or the cursor keys. See figure 3-3. Also, items next to double-headed arrows also can be selected by using the softkey.



**Figure 3-3. Double-Headed Arrow (Filter Screen)**

---

### ... Ellipsis

An ellipsis (three dots following screen text) indicates additional screens will follow when selected. For example, press the Waveform Edit's CREATE key and check out "create blank ...," see figure 3-4.

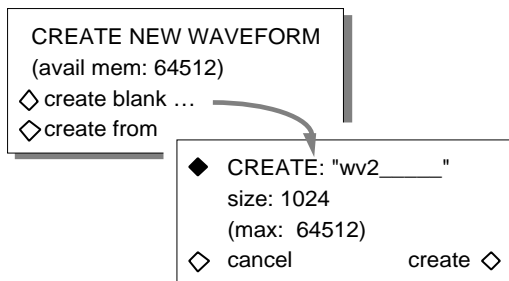


Figure 3-4. "Ellipsis" (Create Screen)

### 3.2.4 Changing Numeric Values

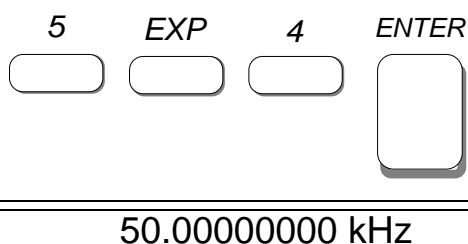
The Model 395 allows you to change numeric values using the numeric keypad or knob. The screen displays modifiable values with the "cursor" starting under the most significant digit. For example, try pressing the OFFSET key.

#### With the Keypad

To enter values using the keypad, press the numeric key. The Model 395 accepts the value when the Enter key is pressed.

The Model 395 accepts values in three basic formats: Integer (10), floating point (10.0), and exponential (1 exp 1).

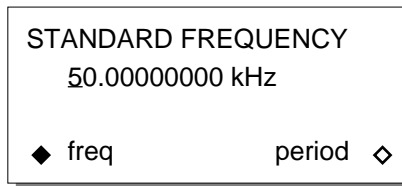
For example, to change the frequency to 50 kHz using the exponential format, enter the value by pressing these keys:



#### Using the Knob

The front panel knob also can be used to change numeric values. When using the knob, values are always changed starting from the digit over the cursor. To modify a value using the knob, place the cursor under the desired digit, and rotate the knob to change the value. Clockwise rotation increases the value; and counterclockwise rotation decrease the values.

For example, to use the knob to set the frequency to 50.35 kHz, press the FREQUENCY key to display the Standard Frequency screen; see figure 3-5. Note: the number of digits shown on the frequency screen depends on the selected waveform.



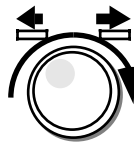
**Figure 3-5. Knob Example**

Use the right “cursor” key to move the cursor over three digits.



50.00000000 kHz

Rotate the knob clockwise until the frequency reads 50.35000000 kHz.



50.35000000 kHz

---

### 3.2.5 Correcting Mistakes

If you make a mistake while entering a value from the front panel, you can make corrections by using the CLEAR key or the BSP (Backspace) key.

Use the CLEAR key to erase the entire value. Pressing ENTER, rotating the knob, or pressing a cursor key, restores the original value providing a value has not been entered via the keypad.

When using the keypad to enter values, press the “BSP (backspace) key to erase the digits to the left of the cursor. Then use the keypad to enter the correct value.

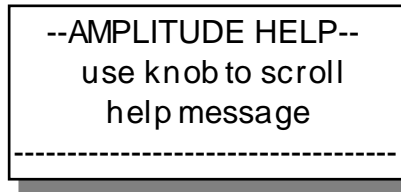
## 3.3 ON-SCREEN HELP

The Model 395 includes on-screen help for the current screen. To access a Help screen, press the HELP “button;” see figure 3- 6. Rotate the knob or use the cursor keys to display additional help lines. Press the HELP key a second time to return to the operation screen.



**Figure 3-6 . Help Key**

For example, press the AMPLITUDE key and then press the HELP key; see below figure 3-7 .

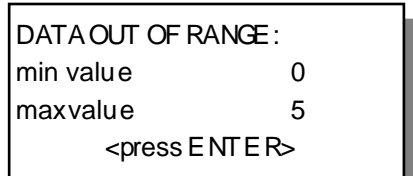


**Figure 3-7 . Amplitude Help Screen**

### 3.4 ERROR MESSAGES

When the Model 395 detects an operational error, it displays a message describing the problem. Press any key to remove the error message and return to the operation screen,

ERROR messages occur if you attempt an illegal operation, such as setting the amplitude outside the range supported by the instrument. For example if you try to program an amplitude of 6 Vp, you will see the message shown in figure 3-8.



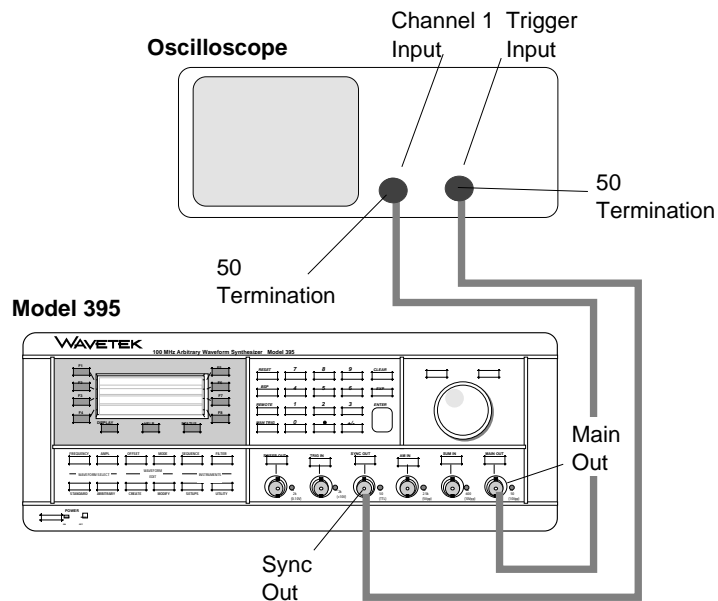
**Figure 3-8 . Error Message Sample**

### 3.5 Initial Setup

Before operating the Model 395, connect the Model 395 to the correct AC power source; see section 2 - Initial Turn-On.

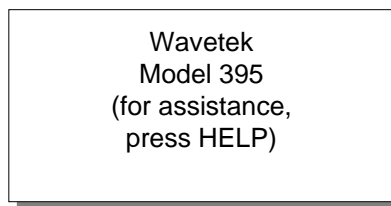
Make sure the fuse in the instrument matches the fuse required for your primary power source voltage. See Section 2, Preparation for Use, Fuse Replacement. Also, be sure the specified line voltage of the unit matches the primary power source. Use the power cord supplied with the unit to connect the Model 395 to the primary power source.

Use the correct cables and terminations to connect the Model 395 to an oscilloscope. Figure 3-9 illustrates a typical setup that connects the Model 395 Main Out to channel 1 on the oscilloscope, and the Sync Out to the scope trigger input. Cables from both outputs must be terminated with 50 . Some scopes contain built-in 50 terminations.



**Figure 3-9. Model 395 to Scope Interconnection**

When the Power is turned on, the Model 395 displays its start-up screen (figure 3-10).



**Figure 3-10. Model 395 Start-up Screen**

### 3.6 MODEL 395 AS A FUNCTION GENERATOR

As a function generator, the Model 395 generates sine, square, triangle, positive ramp, negative ramp, positive haversine, negative haversine,  $\sin(x)/x$ , and dc waveforms.

#### Example 1. Setting Up the Function Generator

This example illustrates how to set up the Model 395 to produce a continuous, 4.58 MHz, 5.4 Vp-p square wave with a -1.2 Vdc offset. Paragraph 5.5.1, example 1 contains the remote SCPI programming equivalent of this example. To view the signal on an oscilloscope, connect the Model 395 to the scope as described in paragraph 3.5. This example is the front panel equivalent of example 1, paragraph 5.5.1.



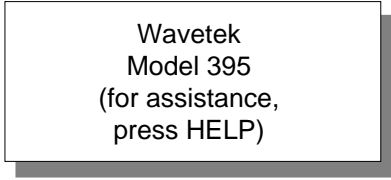
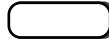
---

## Step 1 Initial Setup and Power On

Connect the Model 395 to a power source - see paragraph 2.6 Initial Turn-On. Push the POWER switch in. The Model 395 displays its start-up screen.

---

POWER

A rectangular screen displaying the following text:

Wavetek  
Model 395  
(for assistance,  
press HELP)

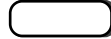
---

## STEP 2. ENABLING THE MAIN OUT

To output the signal generated by the Model 395, you must enable the output by pressing the MAIN OUT key. A lit indicator lights indicates the output is on.

---

MAINOUT



ON



---

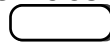
If a scope is connected to the Main Out, you will see a waveform on the scope screen.

## Step 3 Synchronizing the Scope and Model 395

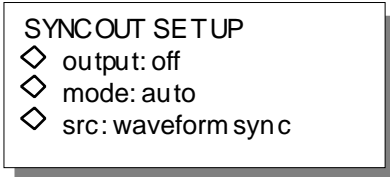
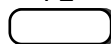
To synchronize the scope signal with the Model 395, press the SYNC OUT key to display the Sync Output Setup screen:

---

SYNCOUT



F2

A rectangular screen displaying the following text:

SYNCOUT SETUP  
◇ output: off  
◇ mode: auto  
◇ src: waveform syn c

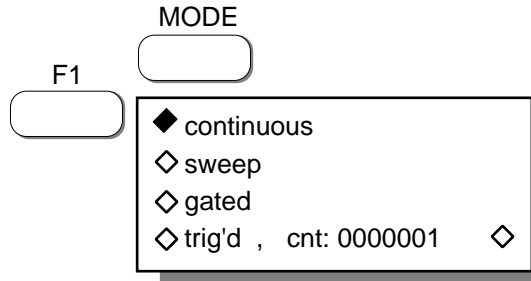
---

Enable the Sync Out signal by pressing F2 "output" until "output: on" appears. The Sync Out indicator lights.

---

## Step 4 Selecting Continuous Mode

Mode defines the operating state (continuous, triggered, etc.) of the Model 395. To set the operating mode to continuous, press the MODE key to display the mode screen:

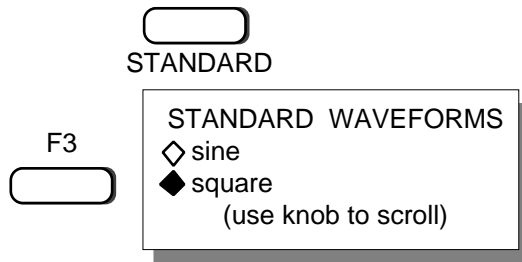


Press F1 “continuous” to selected this mode. Continuous is the default mode.

## Step 5 Selecting Square Wave

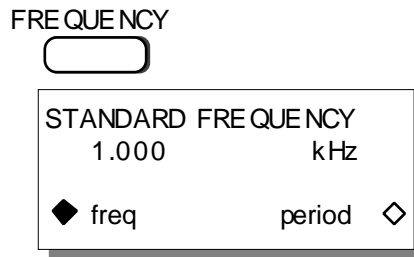
Select a waveform by pressing the STANDARD key under Waveform Select to display the Waveform screen. Select the square wave by pressing the softkey (initially F3) to the left of “square.”

If square is not shown on the screen, rotate the knob until “square” is shown on the screen of the Model 395.



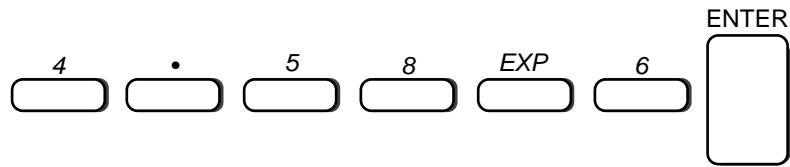
## Step 6 Setting the Frequency to 4.58 MHz

Program the frequency of the square wave by pressing the FREQUENCY key to display the Standard Frequency screen:

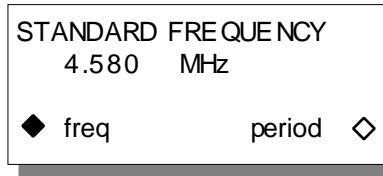


---

To change the frequency, press these keys:



The screen reads:



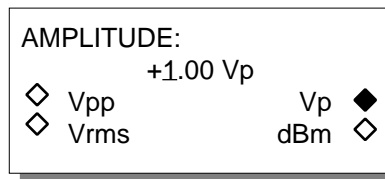
Pressing the softkey F8 will display the period of the square wave.

### Step 7 Setting the Amplitude to 5.4 Vp-p

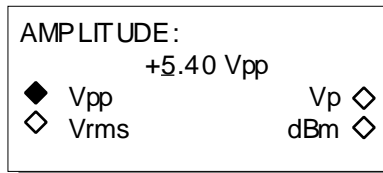
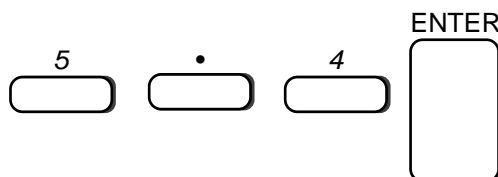
To change the amplitude (waveform level) of the square wave, press the AMPLITUDE key to display the Amplitude screen.

---

AMPLITUDE



Change the Amplitude units to "Vpp" by pressing F3. Then using the keypad, press:

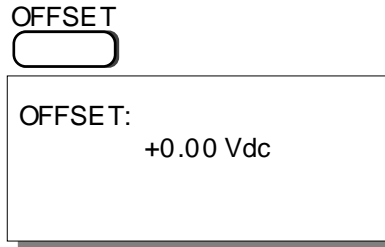


Amplitude units also can be displayed in Vrms (press F4), Vp (press F7), or dBm (press F8).

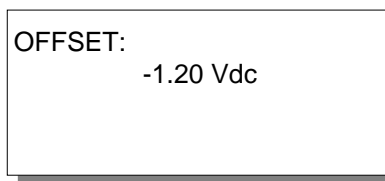
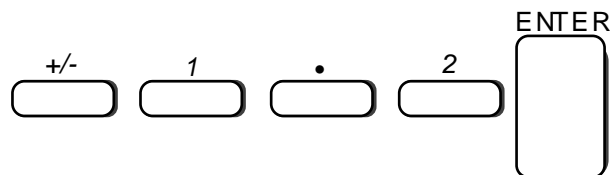
---

## Step 8 Offsetting the Square Wave -1.2 Vdc

To offset (baseline value) the square wave, press the OFFSET key to display the Offset screen:



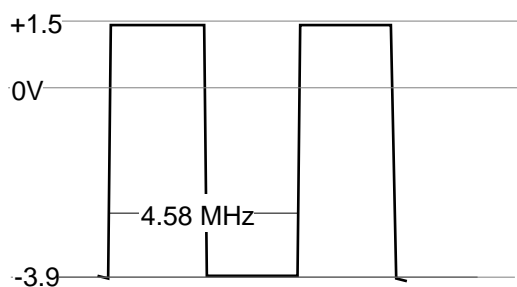
Using the keypad, press:



---

### Summary

If you followed these steps, the scope displays a 4.58 MHz, 5.4 Vp-p square wave offset -1.2 Vdc.



---

## 3.7 MODEL 395 AS AN ARBITRARY WAVEFORM GENERATOR

Arbitrary waveform generators allow you to create and generate custom waveforms. In addition to using the front panel controls, which will be used in these examples, you can use the Model 395's optional GPIB interface to upload waveforms from DSOs. Also, waveforms can be created using waveform generation software like Waveform DSP.

---

These examples guides you through the creation of three Arbitrary waveforms. One waveform, “gray,” demonstrates how to create and output an Arb waveform. The other two Arb waveforms, “sync1” and “sync2” will demonstrate waveform sequencing (paragraph 3.8).

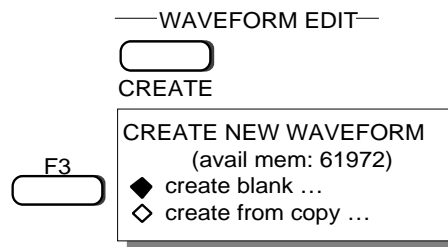
## Example 2 Creating an Arbitrary Waveform Using Line Draw

This example creates waveform that simulates a nine-step gray scale video signal. Paragraph 5.5.2, example 2 contains the remote SCPI programming equivalent of this example. You will use this waveform with example 3.

If you want to view the signal on an oscilloscope, connect the Model 395 to the scope as described in paragraph 3.5. First setup the Model 395 as described in example 1, steps 1, 2, and 3.

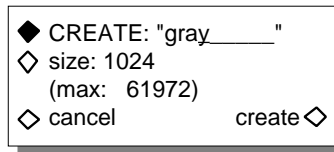
### Step 1 Naming and Sizing the Waveform

The first step in creating the waveform is to name it and define its size. Start by pressing the CREATE key under WAVEFORM EDIT which displays the Create New Waveform screen.



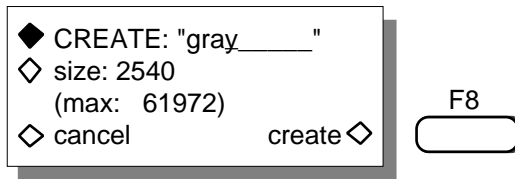
Press F3 to select “create blank ... .” Note: the Model 395 uses ellipsis, ..., to tell you there are additional screens. If you pressed F4, “create from copy ... ,” you could copy an existing waveform and modify the copy.

Give the waveform a name using the knob and right cursor key. Rotate the knob until the first character displays “g” and press the right cursor. Again rotate the knob until the second character displays “r” and press the right cursor. Continue until you have entered “a” and “y.” Both letters and numbers can be used in names, but the first character must always be a letter.



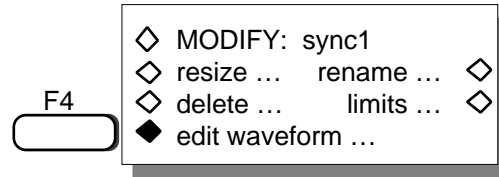
Size defines the number of points in the waveform. Select “size” by pressing the F2 key. Use the keypad to enter 2540 points.



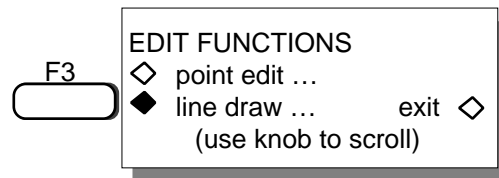


## Step 2. Creating the Waveform

Press F8 “create” to accept the name and size and advance to the Modify screen.

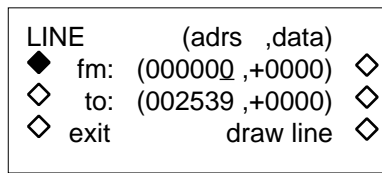


From the Modify screen press F4 “edit waveform” which displays the editing screen. Then from the edit screen, press F3 to select “line draw.”

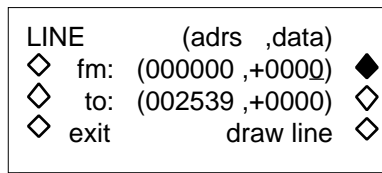


Line draw consists of defining points and drawing lines between the points (address and data value). The range of addresses in this example are 0 to 2539, and the range of data values for each address is -2048 to +2047.

To enter the first point, press F2 “fm ... adrs.”



Then using the keypad enter 0. Next press F6 “fm ... data.”



Then using the keypad, enter 0000. Next press F3 “to ... adrs.”

```

LINE      (adrs ,data)
◇ fm: (000000 ,+000Q) ◇
◆ to: (002539 ,+0000) ◇
◇ exit      draw line ◇
  
```

Next use the keypad to enter 59. Then press F7 “to ... data.”

```

LINE      (adrs ,data)
◇ fm: (000000 ,+0000) ◇
◇ to: (000059 ,+000Q) ◆
◇ exit      draw line ◇
  
```

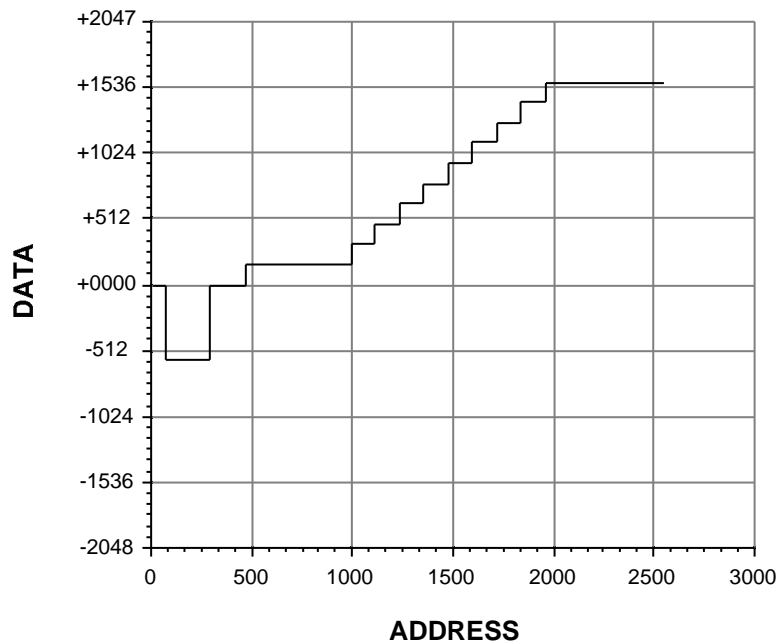
Use the keypad to enter 2048. Finally, press F8 “line draw” to draw the line.

```

LINE      (adrs ,data)
◇ fm: (000000 ,+0000) ◇
◇ to: (000059 ,+2048) ◇
◇ exit      draw line ◆
  
```

Use the following table to enter the rest of the waveform data. Figure 3-11 illustrates the waveform plotted by the data.

	<b>From Adrs</b>	<b>From Data</b>	<b>To Adrs</b>	<b>To Data</b>	<b>Press</b>
60	-577		280	-577	“draw line”
281	+0000		461	+0000	“draw line”
462	+154		981	+154	“draw line”
982	+308		1102	+308	“draw line”
1103	+462		1223	+462	“draw line”
1224	+616		1344	+616	“draw line”
1345	+770		1465	+770	“draw line”
1466	+924		1586	+924	“draw line”
1587	+1078		1707	+1078	“draw line”
1708	+1232		1827	+1232	“draw line”
1828	+1386		1949	+1386	“draw line”
1950	+1540		2539	+1540	“draw line”



**Figure 3-11. Waveform: “gray”**

Press F4 “exit” when finished.

LINE	(adrs ,data)
◇ fm:	(001950 ,+1540) ◇
◇ to:	(002539 ,+1540) ◇
◆ exit	draw line ◇

### Example 3 Generating the Arb Waveform

Now that the Arbitrary waveform “gray” has been created, you can output it like a standard waveform. Paragraph 5.5.2, example 3 contains the remote SCPI programming equivalent of this example. First setup the Model 395 as described in example 1, steps 1, 2, and 3.

#### Step 1 Selecting Arb Waveform “gray”

Press the ARBITRARY key to display the Arbitrary Waveforms screen. The display lists all Arbitrary waveforms stored in memory.



ARBITRARY

ARBITRARY WAVEFORMS

◆ gray	002540
◇ wv1	001024

(use knob to scroll)

Find "gray" and press the softkey next to it; for example, F2.

### Step 2 Selecting Continuous Mode

Select the unit's operating mode by pressing the MODE key which displays the Mode screen.

F1

◆ continuous	
◇ sweep	
◇ gated	
◇ trig'd , cnt:	0000001 ◇

Press F1 to select the continuous mode.

### Step 3 Setting Waveform Period

To set the waveform period, press the FREQUENCY key to bring up the Arbitrary Frequency screen. Press F7, "waveform," and then press F8 "period." Waveform frequency, sample frequency, and sample period can also be displayed.

FREQUENCY

ARBITRARY FREQUENCY	
50.80	μSec
◇ sample	waveform ◆ <input type="text"/> F7
◇ freq	period ◆ <input type="text"/> F8

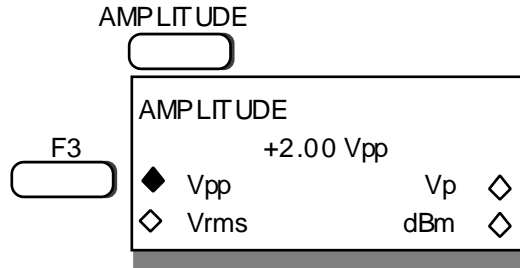
Enter the waveform period by pressing:

6  4  EXP  +/-  6  ENTER

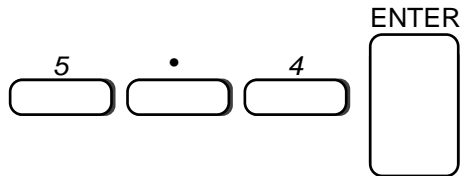
---

### Step 4 Setting the Amplitude

Set the amplitude to 5.4 V<sub>p-p</sub> by first pressing the AMPLITUDE key. From the Amplitude screen, press F3, “V<sub>pp</sub>”, to display the amplitude units in Volts peak-to-peak.



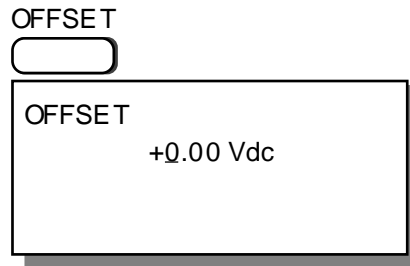
Enter the amplitude level by pressing:



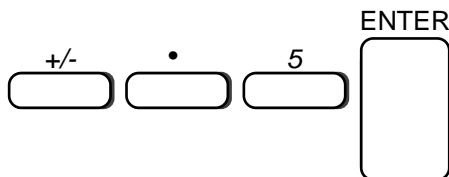
---

### Step 5 Offsetting the Waveform

Offset the waveform's baseline -0.5 V<sub>dc</sub> by pressing the OFFSET key.

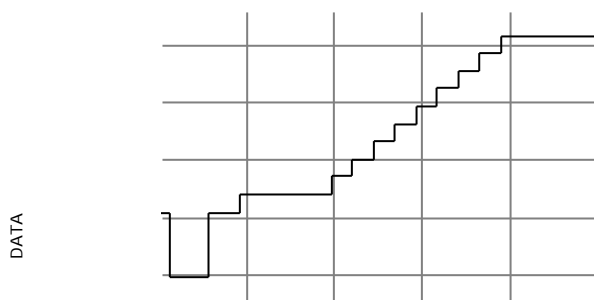


From the Offset screen press:



---

The scope now displays the Gray Scale waveform similar to the one shown below:



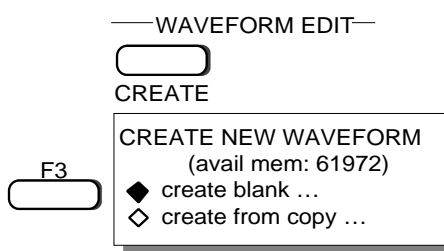
#### Example 4. Creating an Arb Waveform Using Waveform Insert

The waveform, sync1, is a 120 point square wave that illustrates wave insert editing. Paragraph 5.5.2, example 4 contains the remote SCPI programming equivalent of this example. The waveform, sync1, will be used with example 6, creating a sequence.

First set up the Model 395 as described in example 1, steps 1, 2, and 3.

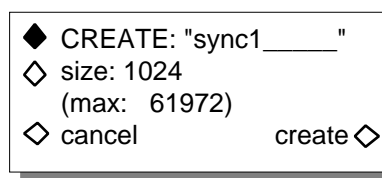
##### Step 1. Naming and Sizing the Waveform

The first step in creating the waveform is to name it and to define its size. Start by pressing the CREATE key under WAVEFORM EDIT which displays the Create New Waveform screen.

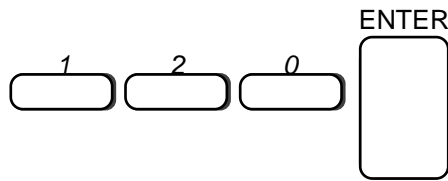


Press F3 to select “create blank ...”

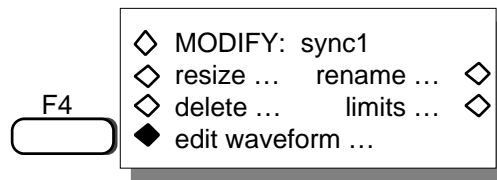
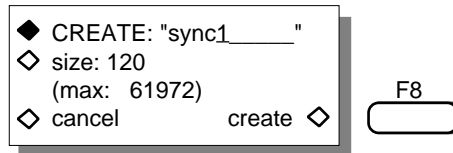
Using the knob and right cursor key name the waveform. Rotate the knob until the first character displays “s” and press the right cursor. Repeat the process until you spell sync1. Both letters and numbers can be used when creating a name, but the first character must always be a letter.



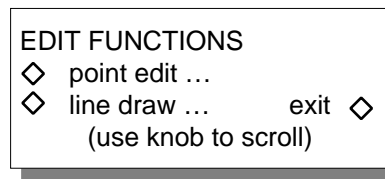
Size defines the number of points in the waveform. Select "size" by pressing the F2 key. Use the keypad to enter 120 points:



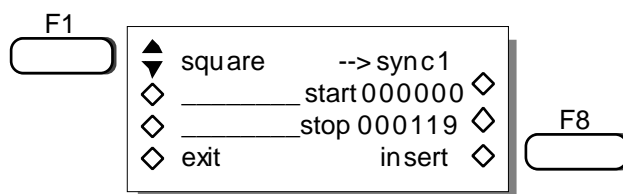
Press F8, "create," to accept the name and the size and advance to the Modify screen.



From the Modify screen press F4 "edit waveform" which displays the Edit screen.



Rotate the knob until Wave Insert appears. Then press the soft key to select Wave Insert ....



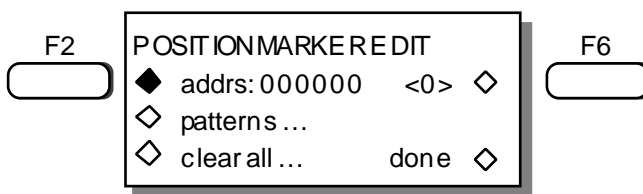
Press F1 until "square" appears. Then press F8 to insert the square wave between address 000000 and address 000119. Select "exit," F4 to return to the waveform edit screen.

## Step 2 Adding Position Markers

You can add position markers to Arbitrary waveform that will consist of a high pulse for the first ten points of the waveform in this example. This pulse will synchronize the scope to the waveform sequence (example 7). To enable the position marker, select sync source: "pos'n mrks" via the SYNC OUT key.

---

From the Waveform Edit screen, scroll to and select “pos’n mrkrs.”



To create the pulse, press F6 to change <0> to <1>. Press F2 to advance to 000001, and press F6 to change to <1>. Continue on to address 000009 setting all points to <1>. Press F8 “done” when finished.

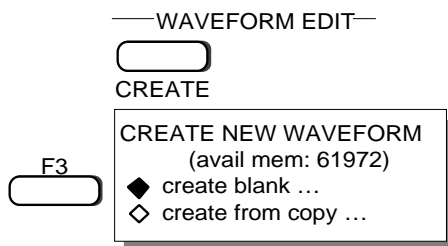
### Example 5. Creating an Arbitrary Waveform Using Point Edit

The waveform, sync2, is a 40 point arbitrary waveform which demonstrates point editing. Paragraph 5.5.2, example 5 contains the remote SCPI programming equivalent of this example. The waveform, sync2, will be used in example 6, creating a sequence.

First setup the Model 395 as described in example 1, steps 1, 2, and 3.

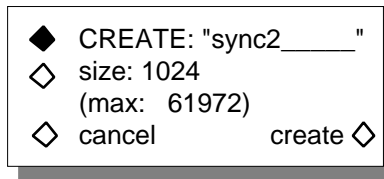
#### Step 1. Naming and Sizing the Waveform

The first step is to give the waveform a name and to define its size (number of points). Start by pressing the CREATE key under WAVEFORM EDIT which displays the Create New Waveform screen.

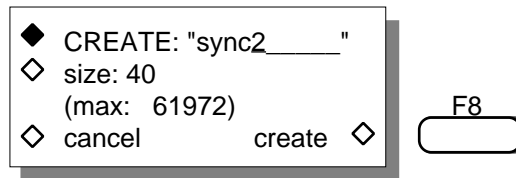
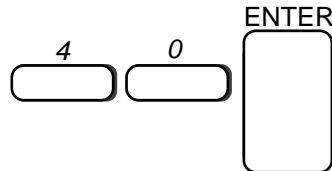


Press F3 to select “create blank ...”

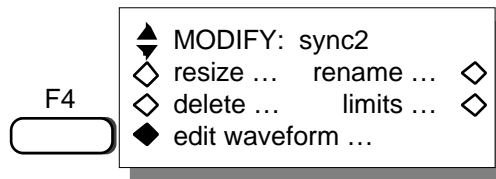
Using the knob and right cursor key name the waveform. Rotate the knob until the first character displays “s” and press the right cursor. Repeat the process until you spell sync2.



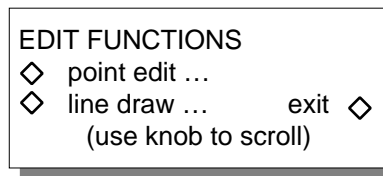
Size defines the number of points in the waveform. Select “size” by pressing the F2 key. Use the keypad to enter 40 points.



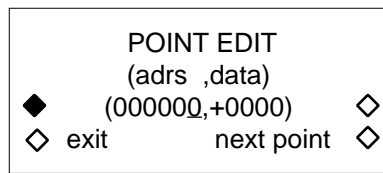
Press F8 “create” to accept the name and size and advance to the Modify screen.



From the Modify screen press F4 “edit waveform” which displays the editing screen.



Press F2 to change to the point edit screen.



To create a waveform using point edit, select the address and enter the data value for that address. Point editing requires you to enter one point at a time. However, if you select “next point” the unit increments to the next address.

---

With the address at 000000, press F7 and enter -2048 from the keypad. Press F8 “next point” to advance to address 000001. Continue entering points as listed below:

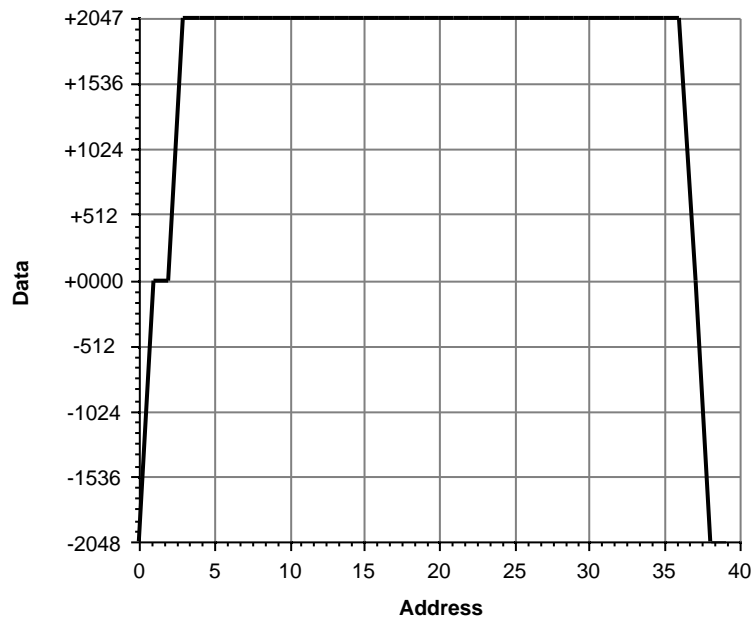
Address	Press F7, enter data	Press F8
000000	-2048	“next point”
000001	-48	“next point”
000002	-48	“next point”
000003	1952	“next point”

000003 to 000036 use data = 1952

000036	4000	“next point”
000037	-48	“next point”
000038	-2048	“next point”
000039	-2048	

Press F4 “exit.”

---



---

## 3.8 THE MODEL 395 AS A WAVEFORM SEQUENCE GENERATOR

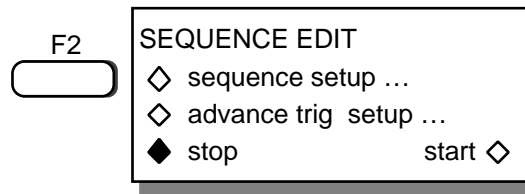
### Example 6 Creating a Waveform Sequence

This sequence combines the waveforms you created in examples 4 and 5 (sync1 and sync2) to form a simulated vertical sync signal for video applications. Paragraph 5.5.3, example 6 contains the remote SCPI programming equivalent of this example.

First setup the Model 395 as described in example 1, steps 1, 2, and 3.

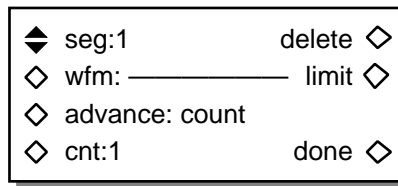
#### Step 1. Accessing Sequence Setup

To begin setting up the sequence, press the SEQUENCE key to display the Sequence Edit screen.



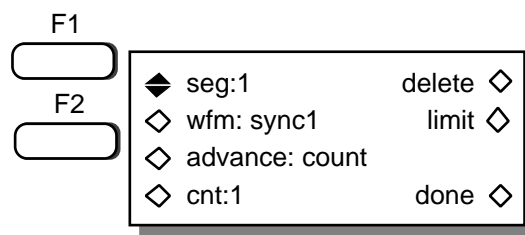
Press F2, “sequence setup ... .”

#### Step 2 . Selecting the First Waveform (Segment)



Press F1, “seg:” until “seg:1” is displayed.

Press F2, “wfm” and use the knob to located “sync1.” If sync1 is unlisted, you should create the waveform: example 4.



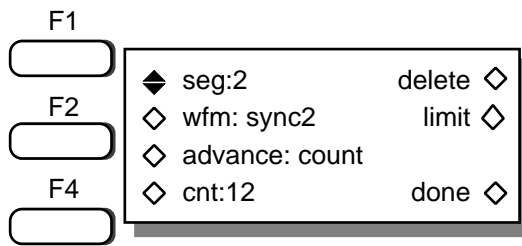
For this example leave the segment set to the default advance: count and count: 1 conditions.

#### Step 3 Selecting the Second Waveform (Segment)

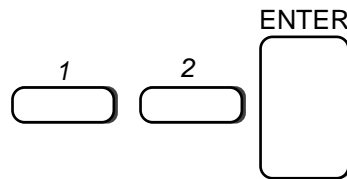
Press F1, “seg:” until “seg:2” is displayed.

Press F2, “wfm:” and use the knob to locate “sync2.” If sync2 is unlisted, you should create the waveform: example 5.



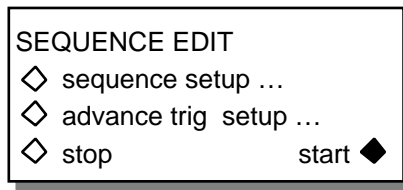


For this example leave advance set to count. But press F4 “cnt,” and set the count to 12 by pressing:



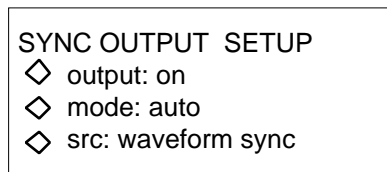
The sequence is now setup.

Press F8, “done” to return to the Sequence Edit screen. Press F8, “start” to run the sequence.



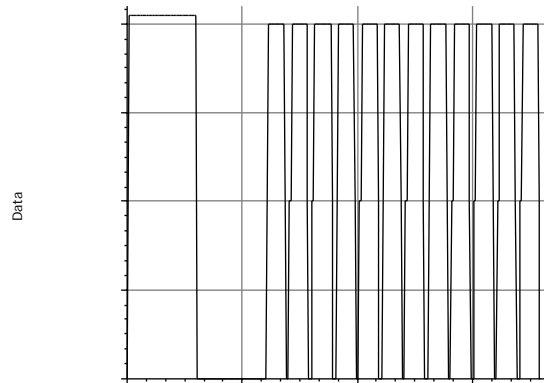
#### Step 4. Synchronizing The Sequence

In example 4 you defined position markers for the “sync1” waveform. To synchronize the scope to the sequence, press the SYNC OUT key to display the Sync Output screen, Then press F2 “output” until “on” appears to enable the Sync Out. Next, press F4 “src:” until “pos’n mark” appears to select the position marker as the sync source.



---

The scope displays:



---

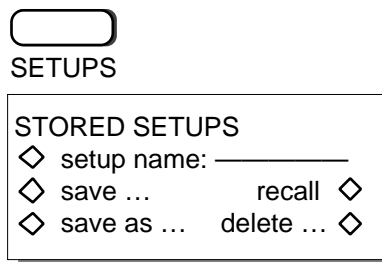
### 3.9 STORING AND RECALLING SETUPS

#### Example 7. Storing and Recalling an Instrument Setup

This example stores the sequence created in example 6. One reason for doing this is because it is the only way the Model 395 will store a sequence. Paragraph 5.5.4, example 7 contains the remote SCPI programming equivalent of this example.

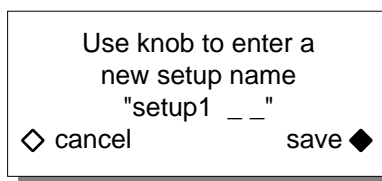
##### Step 1 Storing The Sequence

Press the SETUPS key to display the Stored Setups screen.



---

To store a new setup, press F4 “save as ....”



---

For this example, use the default name “setup1.” If the setup is named “startup” a setup configuration can be used as the power on default.

Press F8, “save” to store the setup.

---

## Step 2. Recalling The Sequence

First turn off the POWER switch, and then turn the POWER back on. Recall the stored setup "setup1" by pressing the SETUPS key.



From the Stored Setups screen, press F2, "setup name:" until "setup1" appears. Then press F7, "recall" to recall the sequence.

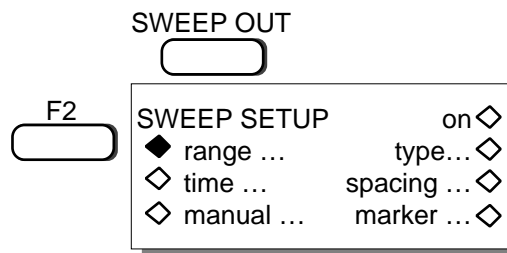
## 3.10 THE MODEL 395 AS A SWEEP GENERATOR

### Example 8. Setting up the Sweep Generator

This example creates a triggered sweep waveform that uses the Model 395's internal trigger source. The generator sweeps between 200 kHz and 400 kHz at a 5 second sweep rate. The trigger source is programmed to 15 seconds. Paragraph 5.5.5, example 8, contains the remote SCPI programming equivalent of this example. First setup the Model 395 as described in example 1, steps 1, 2, and 3.

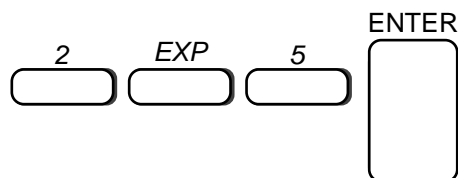
#### Step 1 Accessing the Sweep Setup Screen

Begin by pressing the SWEEP OUT key to switch to the Sweep Setup screen.



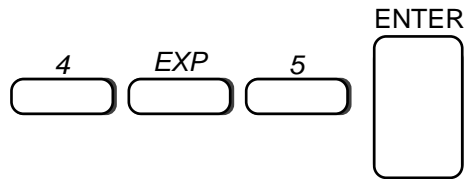
#### Step 2 Setting Sweep Start and Stop Frequencies

Press F2, "range," on the Sweep Setup screen to set the start and stop frequencies. From the Sweep Range screen, set the Start frequency by pressing F2, "start," then using the keypad enter:



---

Press F3, “stop,” and use the keypad to enter:

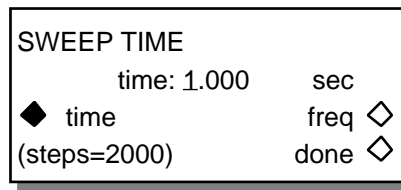


---

Press F8 “done” to return to the Sweep Setup screen.

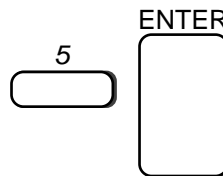
### Step 3 Setting the Sweep Time

Press F3 “time” on the Sweep Setup screen to display the Sweep Time screen.



---

Use the keypad to enter the sweep time:

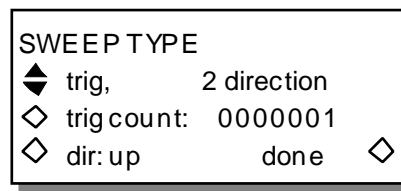


---

Press F8, “done,” to return to the Sweep Setup screen.

### Step 4 Selecting the Sweep Type

From the Sweep Setup screen, press F6 “type” to select the Sweep Type screen.



---

Press F2 and use the knob to locate: “trig, 2 direction .” For this example, leave the sweep direction set to “up” and “trigger count” set to 1. Press F8, “done,” to return to the Sweep Setup screen. Leave the sweep spacing set to linear in this example.

### Step 5 Selecting the Waveform to Sweep

The Model 395 uses the last selected waveform. For this example select the sine waveform by pressing the Waveform Select’s STANDARD key. Then select the sine waveform. For help on how to select a waveform, refer to example 1, step 5.

---

## Step 6 Enabling Sweep

You can select the Sweep mode from either the Sweep Setup screen or the Mode screen. From the Sweep Setup screen, press F5 “on” to switch to the sweep mode. From the Mode screen, press F2 “sweep” to enable the sweep mode. Selecting either one also enables the Sweep Out connector which produces a ramp proportional to the sweep time.

## Step 7 Setting Up Trigger Source

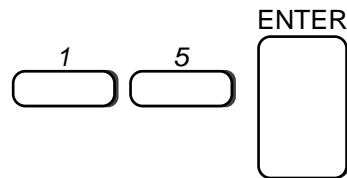
Set up the trigger source and trigger rate via the Trigger screen, enabled by pressing the TRIG IN key.

---

◇	source	: internal
◇	slope	: positive
◇	level	: +0.00 V
◆	period	: 1.0000 ms

---

Select the internal trigger source by pressing F1 “source” until “internal” appears. Set the trigger period to 15 seconds by pressing F4 to select “period” then enter:



The Model 395 is now generating a swept sine wave.

## 3.11 THE MODEL 395 AS A TRIGGER GENERATOR

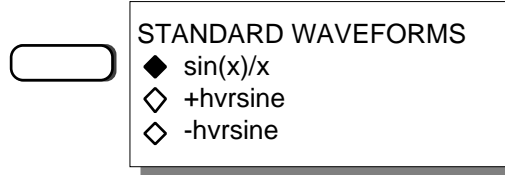
### Example 9 Setting up the Triggered Generator

In this example you will set up the Model 395 to generate a triggered Sin (x)/x waveform for a count of five waveforms. This example uses the Model 395’s MAN TRIG key to trigger the waveforms. Paragraph 5.5.6, example 9 contains the remote SCPI programming equivalent of this example. First setup the Model 395 as described in example 1, steps 1, and 2.

---

### Step 1. Selecting the Sin (x)/x Waveform

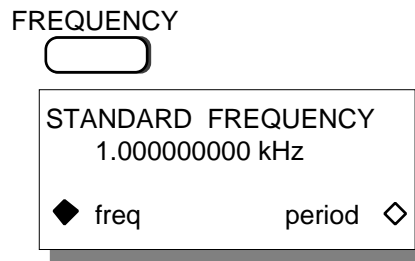
Select a waveform by pressing the STANDARD key under Waveform Select to display the Waveform screen. Rotate the knob until “sin(x)/x” appears on the screen. Press the softkey to the left of “sin(x)/x” to select the waveform.



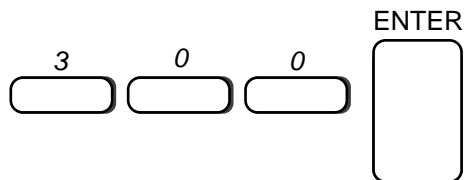
---

### Step 2. Setting the Frequency to 300 Hz

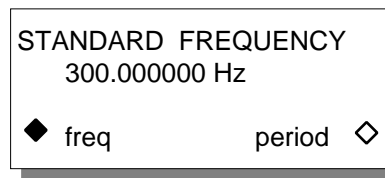
Program the frequency of the waveform by pressing the FREQUENCY key to display the Standard Frequency Screen:



To change the frequency, press these keys:



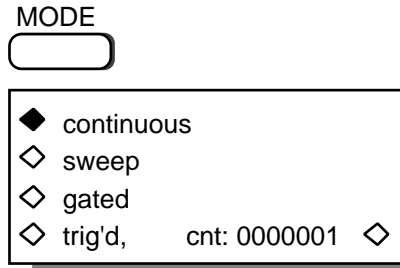
The screen reads:



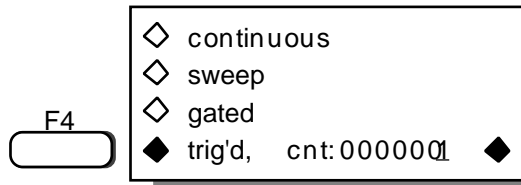
---

### Step 3. Selecting the Triggered Count Mode

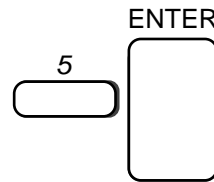
To set the triggered count operating mode, press the MODE key to display the Mode screen:



First select the triggered mode by pressing F4 “trig’d.”

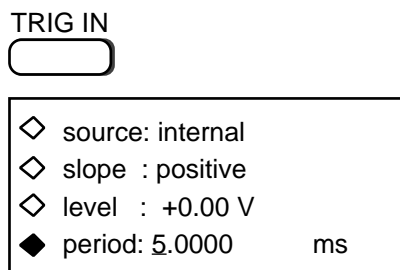


Next enter the trigger count using the keypad to enter:



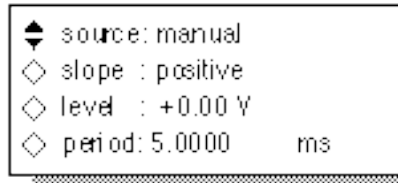
### Step 4. Setting Up the Trigger Source

Set up the trigger source via the Trigger screen, enabled by pressing the TRIG IN key.



---

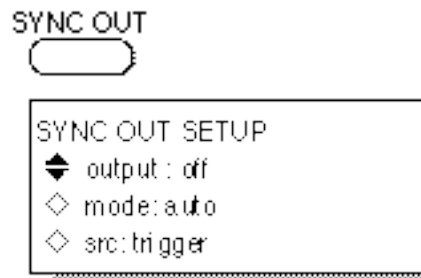
Select the external trigger source by pressing F1 “source:” until “manual” appears:



---

### Step 5. Synchronizing the Scope to the Model 395

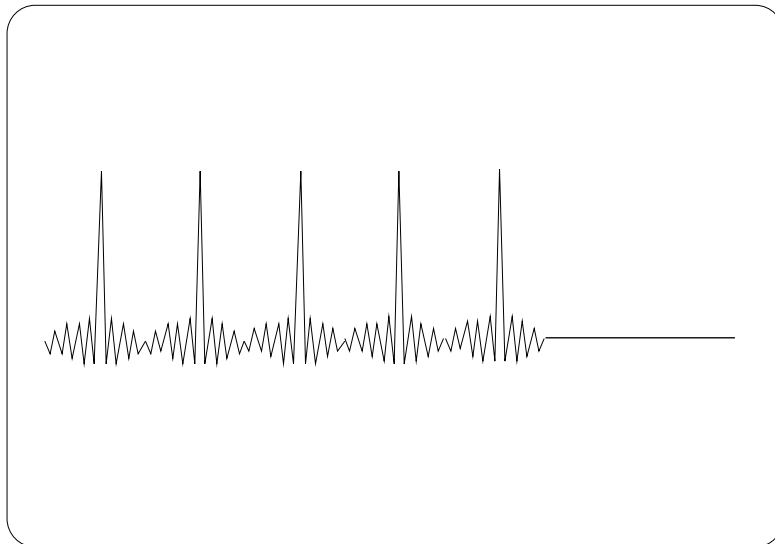
To synchronize the scope signal with the Model 395, press the SYNC OUT key to display the Sync Output Setup screen:



---

Enable the Sync Out signal by pressing F2 until “output: on” appears. The Sync Out indicator lights. Press F4 “src:” until “trigger” appears. Note: when the “mode” is set to auto, the Model 395 automatically selects trigger source.

If you connect the Model 395 to an oscilloscope, as described in paragraph 3.5, you will see a burst of five  $\sin(x)/x$  waveforms each time the Model 395’s MAN TRIG key is pressed. Be sure to setup the scope’s sync correctly in order to see the burst.





---

## 3.12 THE MODEL 395 AS A PULSE GENERATOR

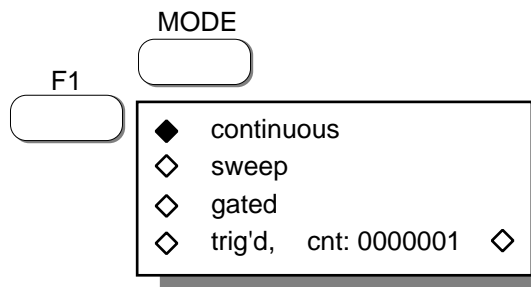
### Example 10 Setting up the Pulse Waveform

This example sets up the Model 395 to produce a continuous 10  $\mu$ s, 1  $\mu$ s wide pulse with fixed rise/fall edges and 2  $\mu$ s delayed relative to the Sync Out signal. Paragraph 5.5.7, example 10 contains the remote SCPI programming equivalent of this example.

First setup the Model 395 as described in example 1, steps 1, 2, and 3. Also, connect the scope and Model 395 as described in paragraph 3.5.

#### Step 1 Selecting Continuous Mode

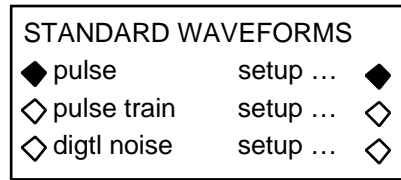
To set the operating mode to continuous, press the MODE key to display the Mode screen:



Press F1, "continuous," to select this mode. Continuous is the default mode.

#### Step 2. Selecting Pulse Setup

Set up the pulse waveform by pressing the STANDARD key under Waveform Select to display the Waveform screen. Rotate the knob to display "pulse setup ..." on the screen.



Selecting "pulse setup" allows you to define the pulse parameters. By selecting "pulse" you enable the pulse waveform using its current parameters.

For this example, press the softkey to the left of "pulse" to allow you to see the pulse as you create it.

---

### Step 3 Setting Up the Pulse Parameters

From the Standard Waveform screen, press the softkey to the right of “pulse setup ...” which displays the Pulse Period screen.

---

Enter pulse period:  
300.0  $\mu$ s  
◇ exit next ◇

---

### Step 4 Programming Pulse Period

From the pulse period screen set the period to 10  $\mu$ s by pressing:

---

1 EXP +/- 5 ENTER

---

### Step 5 Defining the Leading and Trailing Edges

Press F8, “next,” to advance to the Lead/Trail Edge screen. For this example, press F3, “fixed,” to use the fixed rising and falling edges. If “variable” were selected, additional screens will lead you through the setting of the edges.

---

Are lead/trail edges  
fixed or variable?  
◆ fixed variable ◇  
◇ exit next ◇

---

### Step 6 Selecting Pulse Width

Press F8, “next,” to advance to the Pulse Width screen:

---

Enter width:  
program: 5.000  $\mu$ s  
◇ exit next ◇

---

From the Pulse Width screen, set the pulse width to 1  $\mu$ s by pressing:

---

1 EXP +/- 6 ENTER

---

---

## Step 7 Programming Pulse Delay

Press F8, "next," to advance to the Pulse Delay screen.

---

Enter delay:  
program: + 0.000 s  
(actual: +0.000 s)  
◇ exit next ◇

---

From this screen, set the 2  $\mu$ s pulse delay relative to the Sync Out signal. Press these keys:

---

2

EXP

+/-

6

ENTER

---

Press F4, "exit," to return to the Standard Waveform screen.

## Step 8 Setting Upper Pulse Levels

When running a pulse waveform, you can set the upper level of the pulse by pressing the Amplitude key.

---

AMPLITUDE

PULSE UPPER LEVEL:  
  
+1.000 V

---

To set pulse level to +2.5 V press:

---

2

.

5

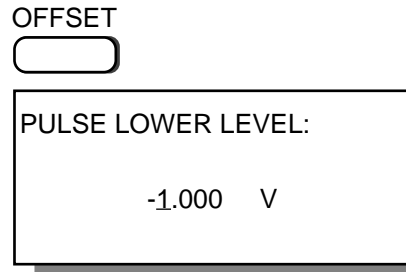
ENTER

---

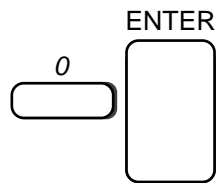
---

## Step 9 Setting Lower Pulse Levels

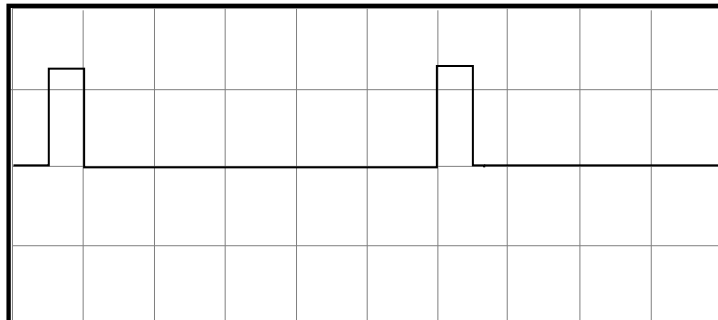
When running a pulse waveform, you can set the lower level of the pulse by pressing the Offset key.



To set pulse level to 0.0 V, press:



The scope displays the following waveform:



---

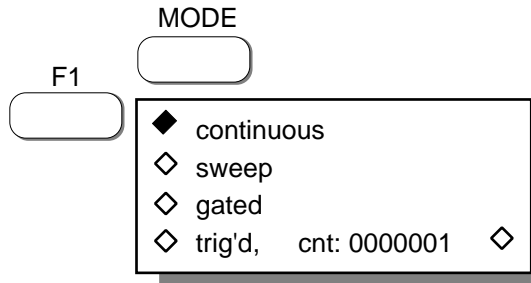
### Example 11 Setting up the Pulse Train Waveform

This example creates a pulse train of three pulses, each with their own widths, levels, and rise/fall times. Paragraph 5.5.7, example 11 contains the remote SCPI programming equivalent of this example. First setup the Model 395 as described in example 1, steps 1, 2, and 3.

---

## Step 1. Selecting Continuous Mode

To set the operating mode to continuous, press the MODE key to display the Mode screen:



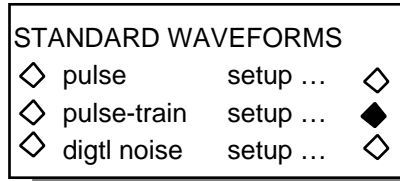
Press F1, “continuous,” to select this mode. Continuous is the default mode.

## Step 2. Selecting Pulse Train

Set up the pulse-train by pressing the STANDARD key under Waveform Select which displays the Standard Waveform screen. Rotate the knob to display “pulse-train setup ...” on the screen.

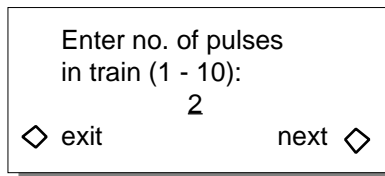
### Note

If “pulse-train” was selected before “pulse-train setup...,”leading edge, trailing edge, and delay screens will also display an actual value.



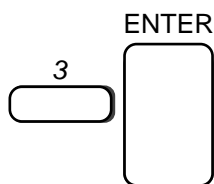
## Step 3 Define Number of Pulses

Selecting “setup ...” displays the “Enter number of pulses ...” screen. A pulse train can contain from 1 to 10 pulses.



---

For this example, program three pulses by pressing:

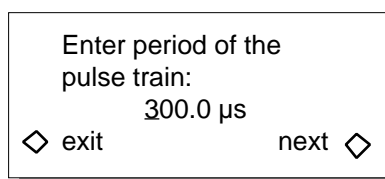


---

Press F8, “next,” to advance to the Pulse Train period screen.

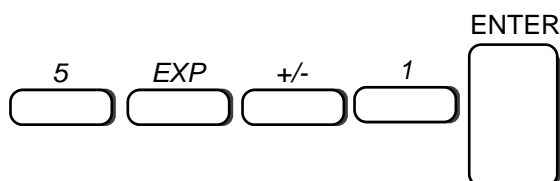
#### Step 4. Programming Pulse Train Period

Pulse train period defines the repetition rate for the entire pulse train.



---

For this example, program the pulse train period to 500 ms by pressing:

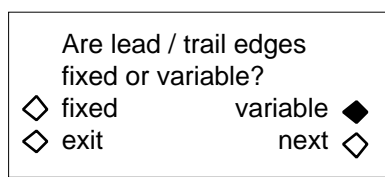


---

Press F8, “next,” to advance to the Edge screen.

#### Step 5 Selecting Fixed or Variable Edges

Pulse train allows you to use fixed leading / trailing edges or set variable leading and trailing edges. This example uses variable edges.

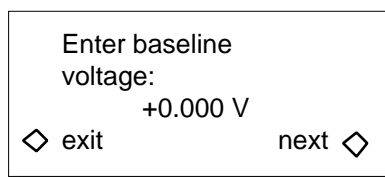


---

Press F7, “variable,” and then press F8, “next,” to advance to the Baseline screen.

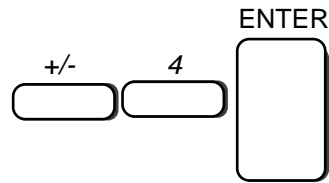
#### Step 6 Setting Baseline

Baseline lets you set a reference voltage level for the entire pulse train.



---

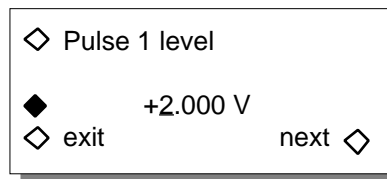
Set the baseline voltage to -4 V by pressing:



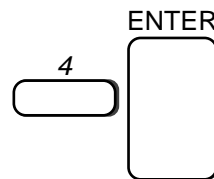
Press F8, “next,” to advance to the Pulse Level screen.

### Step 7 Setting the Level of Pulse 1

Pulse train allows you to define the upper level of each pulse in the train.

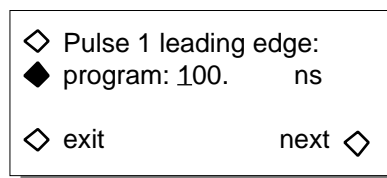


First, select Pulse 1 by pressing F1 until “Pulse 1 Level” appears. Next, press F3, and set the level of pulse 1 to +4 V by pressing:

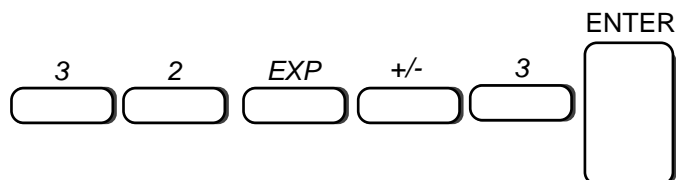


### Step 8 Setting the Leading Edge of Pulse 1

Press F8, “next,” to advance to the Pulse 1 Leading Edge screen.



Set the leading edge to 32 ms by pressing:



---

### Step 9 Setting the Trailing Edge of Pulse 1

Press F8, "next," to advance to the Pulse 1 Trailing Edge screen.

---

◇ Pulse 1 trailing edge:
◆ program: 50. ns
◇ exit next ◇

---

Set the trailing edge of pulse number 1 to 64 ms by pressing:

---

6	4	EXP	+/-	3	ENTER
<input type="text"/>	<input type="text"/>	<input type="text"/>	<input type="text"/>	<input type="text"/>	<input type="text"/>

---

### Step 10 Programming Pulse Width of Pulse 1

Press F8, "next," to advance to the Pulse 1 Pulse Width screen.

---

◇ Pulse 1 width:
◆ program: 1.000 $\mu$ s
◇ exit next ◇

---

Set the pulse width to 120 ms by pressing:

---

1	.	2	EXP	+/-	1	ENTER
<input type="text"/>	<input type="text"/>	<input type="text"/>	<input type="text"/>	<input type="text"/>	<input type="text"/>	<input type="text"/>

---

### Step 11 Programming the Delay of Pulse 1

Press F8, "next," to advance to the Pulse Delay screen. Delay defines the pulse's actual position in the pulse train relative to the Sync Out signal.

---

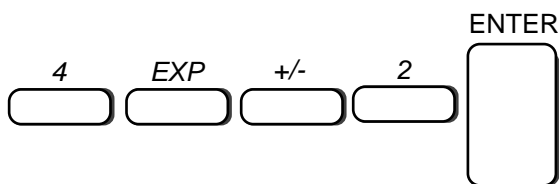
◇ Pulse 1 delay:
◆ program: +0.0000 s
◇ exit next ◇

---



---

For this example, program the delay to 40 ms by pressing:

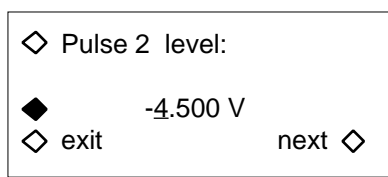


---

Press F8, “next,” to display the Pulse Level screen.

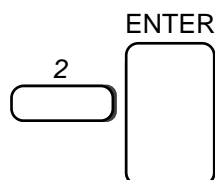
### Step 12 Selecting Pulse 2 and Setting the Level

From the Pulse Level screen, press F1 until “Pulse 2” appears.



---

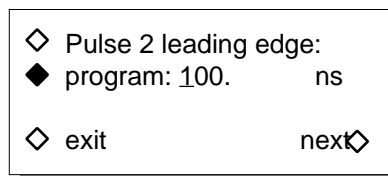
Press F3, and use the numeric keypad to set the upper level to +2 V by pressing:



---

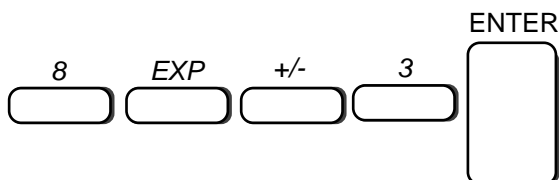
### Step 13 Defining the Leading Edge of Pulse 2

Press F8, “next,” to display the Leading Edge screen.



---

Set the leading edge to 8 ms by pressing:



---

## Step 14 Programming the Trailing Edge of Pulse 2

Press F8, "next," to display the Trailing Edge screen.

```
◇ Pulse 2 trailing edge:
◆ program: 50.          ns
◇ exit                  next ◇
```

Set the trailing edge to 8 ms by pressing:

```
8  EXP  +/-  3  ENTER
┌──┬──┬──┬──┬──┐
└──┴──┴──┴──┴──┘
```

---

## Step 15 Changing Pulse Width of Pulse 2

Press F8, "next," to display the Pulse Width screen.

```
◇ Pulse 2 width:
◆ program: 1.000    μs
◇ exit              next ◇
```

Set the pulse width of pulse number 2 to 60 ms by pressing:

```
6  EXP  +/-  2  ENTER
┌──┬──┬──┬──┬──┐
└──┴──┴──┴──┴──┘
```

---

## Step 16 Setting Pulse Delay of Pulse 2

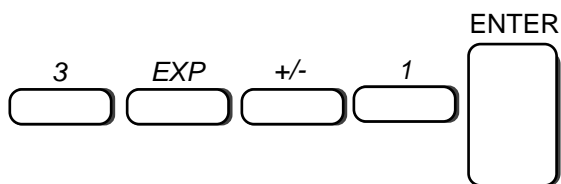
Press F8, "next," to advance to the Pulse Delay screen. Delay defines the pulse's actual position in the pulse train relative to the Sync Out signal.

```
◇ Pulse 2 delay:
◆ program: +0.0000  s
◇ exit              next ◇
```

---

---

For this example, program the delay to 300 ms by pressing:

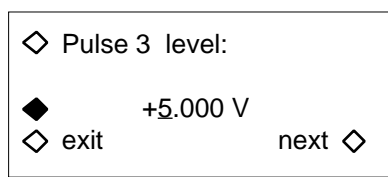


---

Press F8, "next," to display the Pulse Level screen.

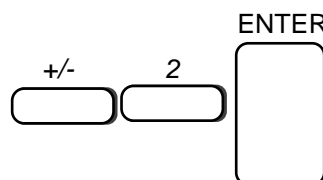
### Step 17 Selecting Pulse 3 and Setting the Level

From the Pulse Level screen, press F1 until "Pulse 3" appears.



---

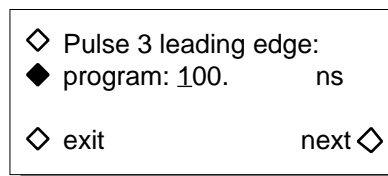
Press F3, and use the numeric keypad to set the upper level to -2 V by pressing:



---

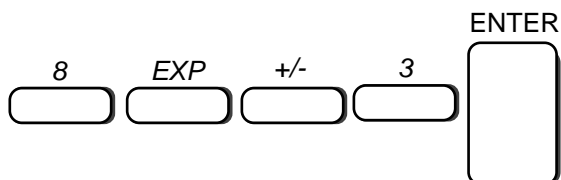
### Step 18 Defining the Leading Edge of Pulse 3

Press F8, "next," to display the Leading Edge screen.



---

Set the leading edge to 8 ms by pressing:



---

### Step 19 Programming the Trailing Edge of Pulse 3

Press F8, "next," to display the Trailing Edge screen.

---

◇ Pulse 3 trailing edge:	
◆ program: 50.	ns
◇ exit	next◇

---

Set the trailing edge to 32 ms by pressing:

---

3	2	EXP	+/-	3	ENTER
<input type="text"/>	<input type="text"/>	<input type="text"/>	<input type="text"/>	<input type="text"/>	<input type="text"/>

---

### Step 20 Changing Pulse Width of Pulse 3

Press F8, "next," to display the Pulse Width screen.

---

◇ Pulse 3 width:	
◆ program: 1.000	μs
◇ exit	next ◇

---

Set the pulse width of pulse 3 to 50 ms by pressing:

---

5	EXP	+/-	2	ENTER
<input type="text"/>	<input type="text"/>	<input type="text"/>	<input type="text"/>	<input type="text"/>

---

### Step 21 Setting Pulse Delay of Pulse 3

Press F8, "next," to advance to the Pulse Delay screen. Delay defines the pulse's actual position in the pulse train relative to the Sync Out signal.

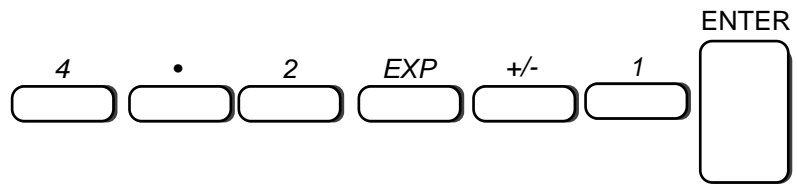
---

◇ Pulse 3 delay:	
◆ program: +0.0000	s
◇ exit	next ◇

---

---

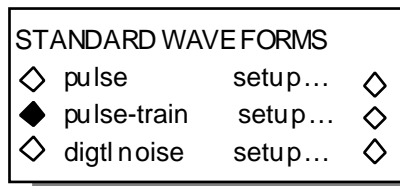
For this example, program the delay to 420 ms by pressing:



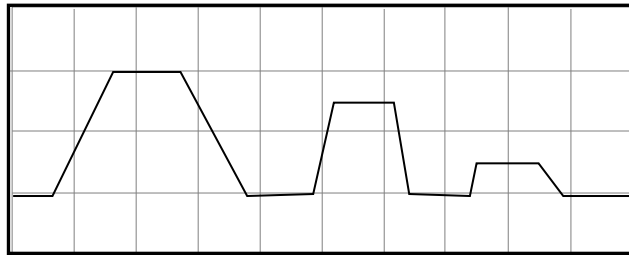
Press F4, "exit," to return to the Standard Waveform screen.

### Step 21 Viewing the Pulse Train

First connect the scope and Model 395 as described in paragraph 3.5. Press the softkey to the left of "pulse-train."



The scope displays:



## 3.13 THE MODEL 395 AS A NOISE GENERATOR

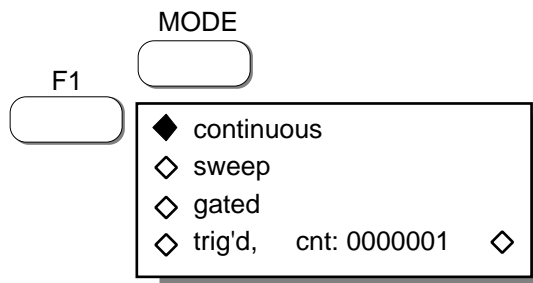
### Example 12 Setting Up the Signal To Noise Waveform

This example creates a 100 kHz sine waveform with 50% noise. Paragraph 5.5.8, example 12 contains the remote SCPI programming equivalent of this example. First setup the Model 395 as described in example 1, steps 1, 2, and 3.

---

## Step 1 Selecting Continuous Mode

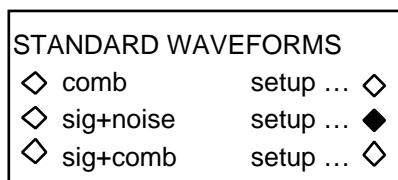
To set the operating mode to continuous, press the MODE key to display the Mode screen:



Press F1, "continuous," to select this mode. Continuous is the default mode.

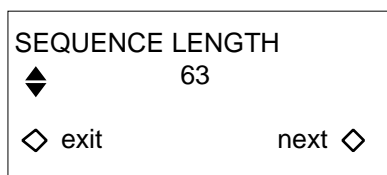
## Step 2. Selecting Signal + Noise Setup

Set up the signal + noise waveform by pressing the STANDARD key under Waveform. Select to display the Waveform screen. Rotate the knob to display "sig+noise setup ..." on the screen.



## Step 3 Defining the Sequence Length

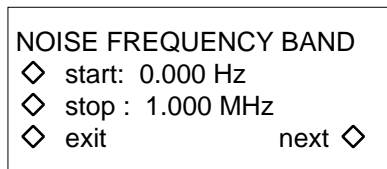
Select "sig+noise setup" to display the Sequence Length screen.



Rotate the knob until the screen displays the sequence length: 4095.

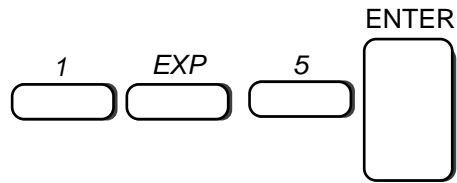
## Step 4 Setting the Noise Frequency Bandwidth

Press F8, "next," to advance to the Noise Bandwidth screen.



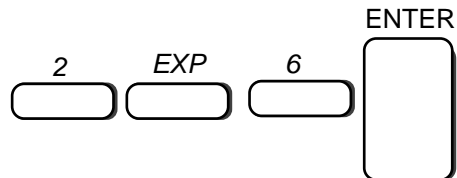
---

First, set the start frequency to 100 kHz by pressing:



---

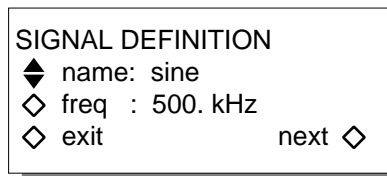
Next set the stop frequency by pressing F3, “stop,; and entering 2 MHz by pressing:



---

### Step 5 Defining the Signal

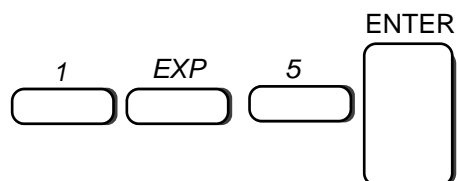
Press F8, “next,;” to display the Signal Definition screen.



---

From this screen, you define the frequency and waveform that will be mixed with the noise.

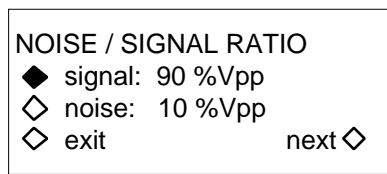
Press F2, “name,;” until “sine” appears. Next, set the frequency of the sine wave by pressing F3, “freq,;” Then, set the frequency to 100 kHz by pressing:



---

### Step 6 Setting the Signal to Noise Ratio

Press F8, “next,;” to display the Noise/Signal Ratio screen.

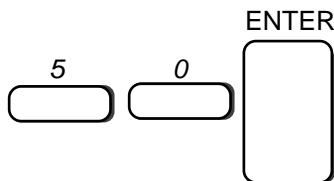


---

The ratio is entered as a percentage of the peak to peak value of the selected waveform (sine in this case) or the noise.

---

Set the percentage to 50 % Vp-p by pressing:

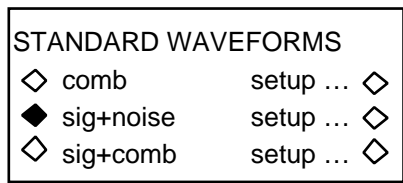


---

Press F4, "exit," to return to the Standard Waveform screen.

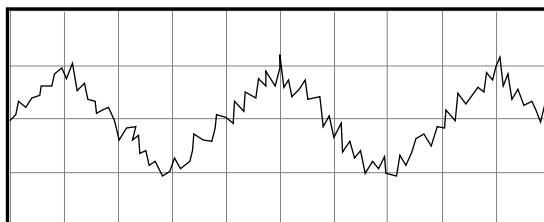
### Step 8 Viewing Signal To Noise

To view signal to noise, first connect the scope and Model 395 as described in paragraph 3.5.



---

Select "sig+noise" and view the Model 395's output on the scope:



---

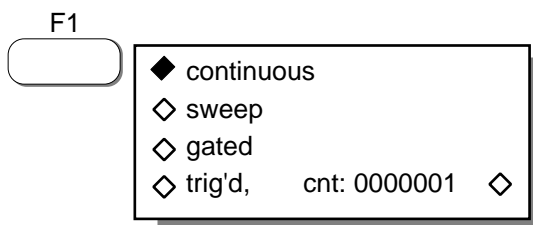
## 3.14 THE MODEL 395 AS AN AMPLITUDE MODULATION SIGNAL SOURCE

### Example 13 Setting Up Amplitude Modulation

This example produces a 600 kHz 50% Amplitude Modulated Sine wave. This example requires you to use an external modulating source. Paragraph 5.5.9, example 13 contains the remote SCPI programming equivalent of this example. First setup the Model 395 as described in example 1, steps 1, 2, and 3.

#### Step 1 Selecting Continuous Mode

To set the operating mode to continuous, press the MODE key to display the Mode screen:



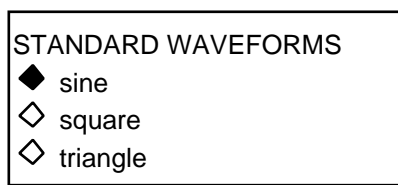


---

Press F1, “continuous,” to select this mode. Continuous is the default mode.

## Step 2. Selecting the Waveform

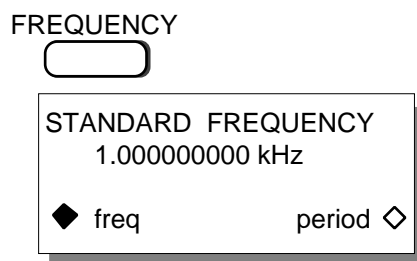
Select the sine wave by pressing the STANDARD key under Waveform Select to display the Waveform screen. Rotate the knob to display “sine” on the screen.



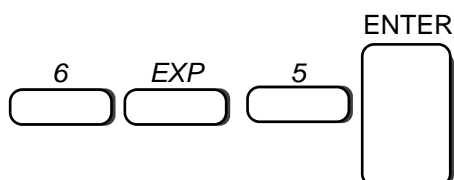
Select the sine wave by pressing the softkey to the left of “sine.”

## Step 3 Setting the Frequency to 600 kHz

Program the frequency of the square wave by pressing the FREQUENCY key to display the Standard Frequency screen:

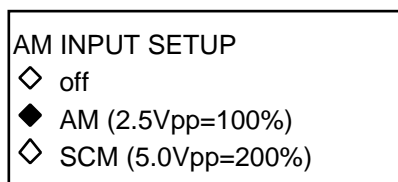


To change the frequency, press these keys:



## Step 4 Setting Up the AM Input

To enable the AM IN connector and select the AM mode, press the AM IN key which displays the AM Input Setup screen.



Press F3, “AM (2.5Vpp=100%),” to both enable the AM IN connector and switch to the AM mode.

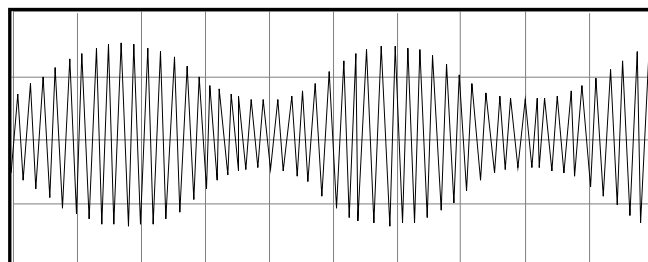
---

### Step 5 Viewing the AM Signal

Connect the scope and Model 395 as described in paragraph 3.5. Setup the external signal generator to 2 kHz, 1.25 Vp-p sine wave. Connect an external signal generator's Function Output to the to the Model 395's AM IN connector. Be sure to properly terminate the external signal generator's Function Output.

Also try to create the AM signal using the Model 395's internal AM waveform.

The scope displays a 600 kHz "carrier" that is modulated to 50% modulation by a 2 kHz sine wave.



---

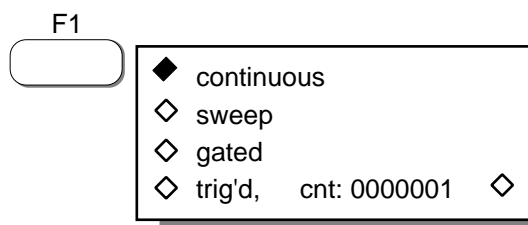
## 3.15 THE MODEL 395 SUMMING INPUT

### Example 14. Setting Up Summing Input

Example 14 sums an external TTL waveform with analog noise from the Model 395. Paragraph 5.5.10, example 14 contains the remote SCPI programming equivalent of this example. First setup the Model 395 as described in example 1, steps 1, 2, and 3.

#### Step 1 Selecting Continuous Mode

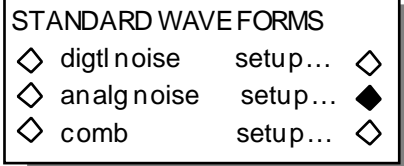
To set the operating mode to continuous, press the MODE key to display the Mode screen:



Press F1, "continuous," to select this mode. Continuous is the default mode.

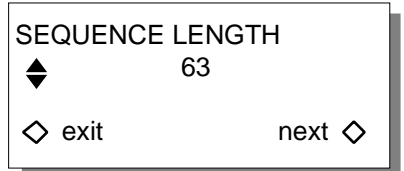
#### Step 2. Selecting Analog Noise Setup

Set up analog noise by pressing the STANDARD key under Waveform Select to display the Waveform screen. Rotate the knob to display "analg noise setup ..." on the screen.



### Step 3 Defining the Sequence Length

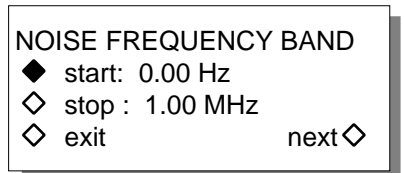
Select “analg noise setup...” to display the Sequence Length screen.



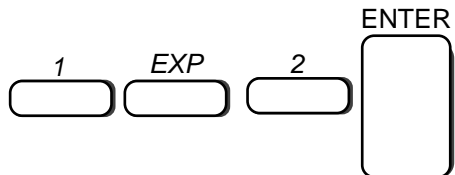
Rotate the knob until the screen display the sequence length: 4095.

### Step 4 Setting the Noise Frequency Bandwidth

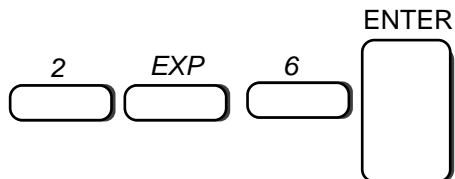
Press F8, “next,” to advance to the Noise Bandwidth screen.



First, set the start frequency to 100 Hz by pressing:



Next set the stop frequency by pressing F3, “stop,” and entering 2 MHz by pressing:



### Step 5 Setting Up Summing Input

To begin setting up the Sum Input, press the SUM IN key and the Model 395 displays the Sum Input Setup screen.

---

---

SUM IN SETUP

- ◇ input: off
- ◇ atten: -12 dB ( / 4)
- ◇ atten mode: auto

---

Enable the Sum In connector by pressing F2 until the “input: on” is displayed. Then press F3 until the screen displays “0 dB (/1).”

**Step 6. Connect the Sum In Signal**

Connect the external Sum Source to the Model 395’s Sum In connector, and set the signal source to 1 kHz, 2 Vp-p sine wave. Connect the Main Out from the Model 395 to channel 1 on the scope. Sync the scope from the Sum Source. Be sure to properly terminate the outputs from the Sum Source and Model 395.

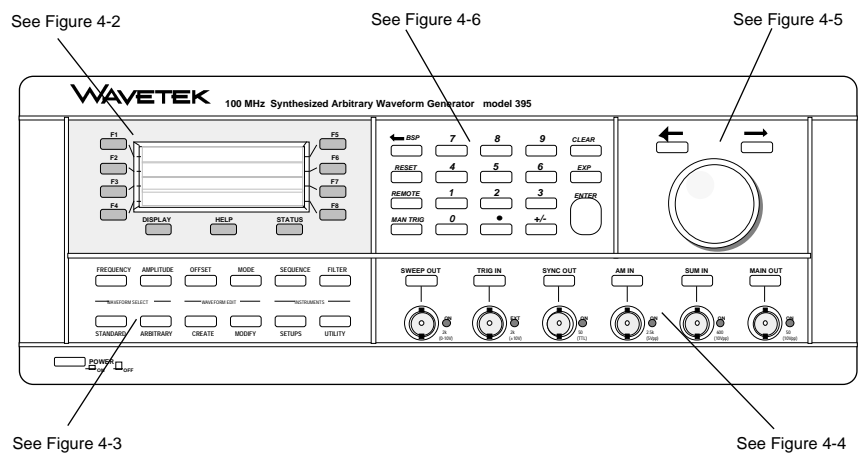
## 4.1 INTRODUCTION

This section contains the front panel operational reference information for the Model 395. Paragraph 4.2 summarizes the front panel controls and connectors, and paragraph 4.3 describes switches and connectors on the rear panel. Paragraph 4.4 contains the detailed operation reference information based on front panel keys and their screens.

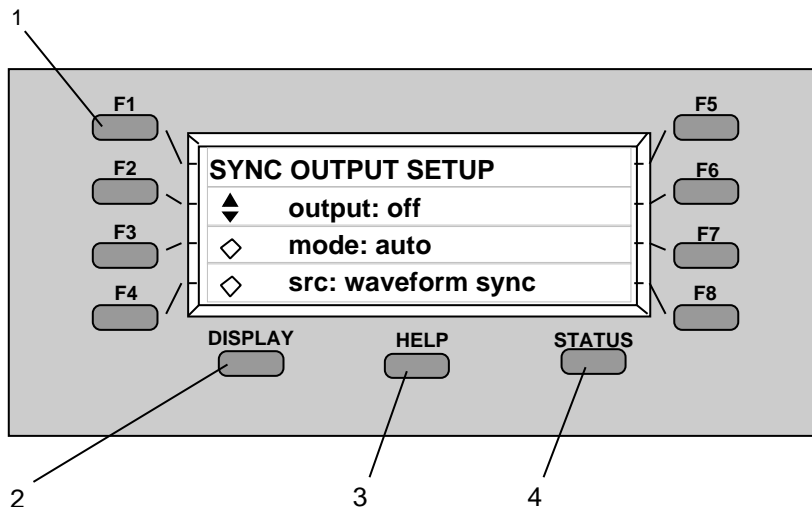
## 4.2 FRONT PANEL

Figure 4-1 illustrates the front panel of the Model 395. The figures, referenced in figure 4-1, are described in the following list of figures and tables.

Figure 4-2	Softkeys	Table 4-1.
Figure 4-3	Operation Keys	Table 4-2.
Figure 4-4	Connector Control Keys	Table 4-3
Figure 4-5	Knob and Cursor	Table 4-4
Figure 4-6	Numeric Key Group	Table 4-5



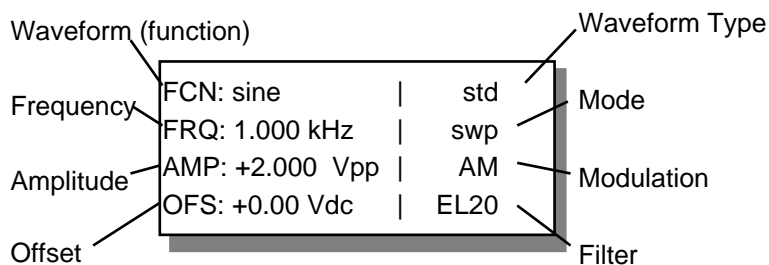
**Figure 4-1. Front Panel**

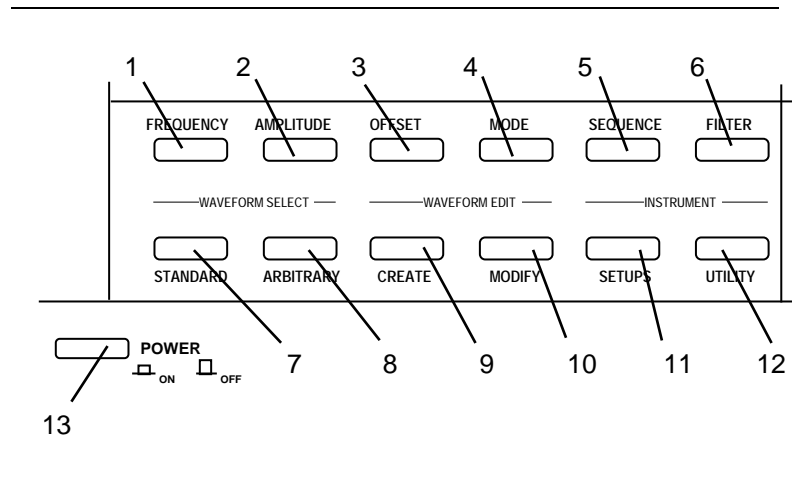


**Figure 4-2. Softkeys, Display, Help, and Status**

**Table 4-1. Softkeys, Display, Help, and Status**

Ref.	Name	Function
1	F1 - F8	These softkeys select items displayed on screen. A filled diamond (◆) identifies selected screen items. A hollow diamonds (◇) identifies non-selected screen items.  Double arrows (◀▶) identifies additional items are available.
2	DISPLAY	This key controls the LCD contrast. There are eleven contrast levels. Each key press advances the contrast to the next level. The last level loops to the beginning.
3	HELP	This key displays help information for the current screen. Rotate the knob to display additional help information. Press the HELP key a second time to exit help.
4	STATUS	Press this key to display the current instrument status:





**Figure 4-3. Operation Keys**

**Table 4-2. Operation Keys**

Ref	Name	Function
1	FREQUENCY	Press this key to display the current frequency or period of the selected waveform. For Arb waveforms, the screen displays the sample frequency or period as well as waveform frequency or period. To change the value, use the knob or front panel keypad. For details, see paragraph 4.4.5 - Frequency.
2	AMPLITUDE	Press this key to display the current Main Output amplitude level. Use the softkeys to display the level in Volt peak to peak, (Vp-p), Volt RMS ( $V_{RMS}$ ), Volt peak (Vp), and dBm. To change the level, use the knob or front panel keypad. The Model 395 assumes the output signal is terminated into 50 . Maximum amplitude is $\pm 10$ Vp-p. Refer to paragraph 4.4.1 - Amplitude.  When using pulse waveform, Amplitude sets the upper level of the pulse.
3	OFFSET	Press this key to display the current dc offset value relative to the waveform baseline. In the dc function (waveform), the screen displays the output level. The maximum offset range is $\pm 5.00$ Vdc into 50 . Refer to paragraph 4.4.7 - Offset for additional details.  When using pulse waveform, Offset sets the lower level of the pulse.
4	MODE	This key displays the current Model 395 operating mode. There are four modes: Continuous, Sweep, Gated, and Triggered. Use the softkeys to select the mode. Refer to paragraph 4.4.6 - Mode for details.

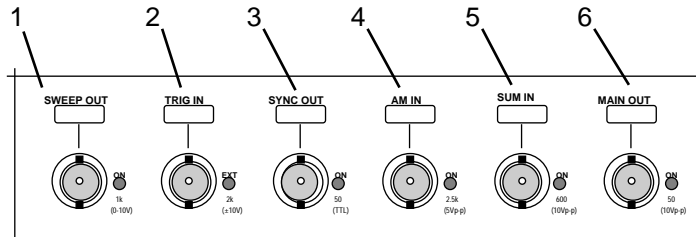
**Table 4-2. Operation Keys (Continued)**

<b>Ref</b>	<b>Name</b>	<b>Function</b>
5	SEQUENCE	Use this key to display the Sequence Edit screen. From this screen, link waveforms in a sequence, setup advance trigger conditions, select waveform loop counts, and start or stop the sequence. Also, see paragraph 4.4.10 - Sequence.
6	FILTER	This key displays available output filters. 20 MHz Elliptic filter 40 MHz Elliptic filter 10 MHz Bessel filter No Filter For more information, see paragraph 4.4.4 - Filter.
7	STANDARD	This key lists the Model 395's standard, pulse, noise, and sequence waveforms. Use the softkeys to select the desired waveform. Rotate the knob to display additional waveforms. Selecting "arb" displays all programmed Arbitrary waveforms. Refer to paragraph 4.4.12, Standard Waveforms for additional details.
8	ARBITRARY	Press this key to list programmed Arbitrary (user-defined) waveforms. Use the soft keys to select any of these waveforms. Rotate the knob or press the cursor keys to display additional waveforms. Refer to paragraph 4.4.3 - Arbitrary Waveforms.
9	CREATE	This key allows you to create arbitrary waveforms from scratch (blank) or from existing waveforms (copy). Refer to paragraph 4.4.3 - Arbitrary Waveforms for details.
10	MODIFY	Press this key to modify existing Arbitrary waveforms. Utilize the Modify screen to edit, rename, and resize a waveform, as well as, set the start and stop address for the waveform. Refer to paragraph 4.4.3 - Arbitrary Waveforms.
11	SETUPS	Press this key to store and recall complete instrument setups. Use the screen to save a new setup, to recall an existing setup, or to delete any existing setup. Refer to paragraph 4.4.11 - Setup.
12	UTILITY	Press this key to list the Model 395 utility screens. From this screen perform the unit's calibration procedure; view system information which includes firmware revision and memory size; power-on configures the power on setup; calibration leads you through the Model 395 calibration procedure; and DSO upload configures the unit for DSO upload (GPIB/Direct DSO Waveform Transfer Option 001 required). For details refer to paragraph 4.4.18 - Utility



**Table 4-2. Operation Keys (Continued)**

Ref	Name	Function
13	POWER	<p>This switch turns the Model 395 ON and OFF. Press the switch in to turn the unit ON. Press the switch again to turn OFF the Model 395. When in the off position, ac line power is disconnected from the internal power supply circuits.</p> <p>The Model 395 requires at least a 20 minute warm up before specifications apply.</p>



**Figure 4-4. Connector Control Keys**

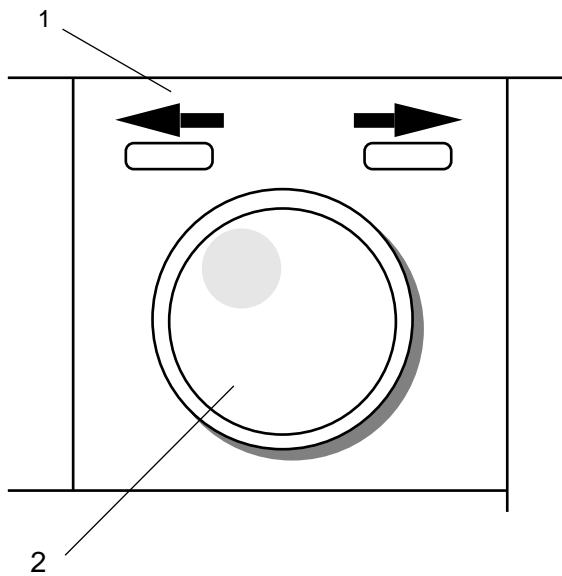
**Table 4-3. Connector Control Keys**

Ref	Name	Function
1	SWEEP OUT	<p>Press this key to display the Sweep Setup screen from which you can define Sweep Range, Sweep Time, Sweep Type, and Sweep Spacing, and Sweep Marker.</p> <p>In addition, use this screen to define the sweep marker and to select manual (knob) sweep operation.</p> <p>Refer to paragraph 4.4.15 - Sweep for additional information.</p>
	Sweep Out	<p>This output connector supplies a linear sweep horizontal ramp (0 to 10V) with a level proportional to sweep time. A lit indicator means the output is on. Output impedance is 2k .</p>
2	TRIG IN	<p>Press this key to setup trigger parameters. Select internal or external (Trig In BNC or Man Trig key) trigger source. Select the trigger slope and level for external trigger. Plus, set the repetition rate for internal trigger source.</p> <p>See paragraph 4.4.17 - Trigger for additional information.</p>
	Trig In	<p>This is the input connector for external trigger source. Input impedance is 2k . Level range is ±10V.</p>
3	SYNC OUT	<p>Press this key to turn the Sync Out on or off and to select the sync source: trigger, pen lift, waveform sync, pos'n marker, sweep marker, burst done, and loop done.</p> <p>See paragraph 4.4.16 - Sync Out for additional information.</p>
	Sync Out	<p>This is the Sync Output connector which is selected using SYNC OUT key. Output is TTL into 50 .</p>

---

**Table 4-3. Connectors and Control Keys (Continued)**

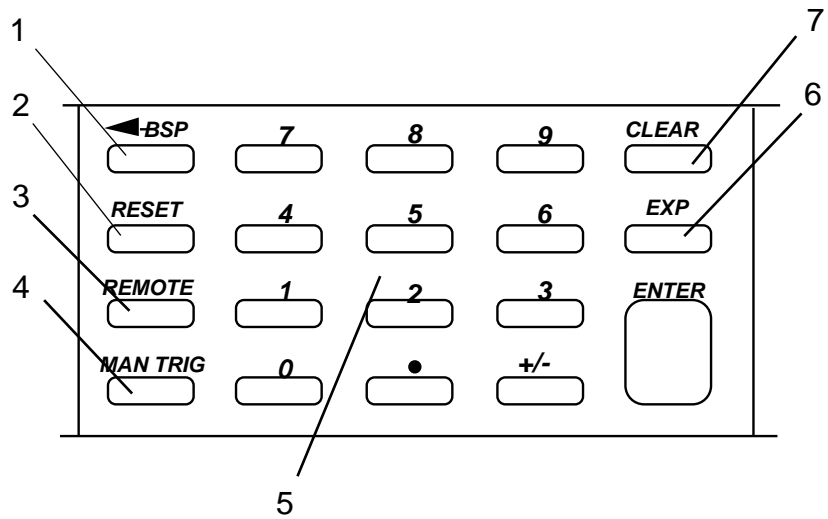
Ref.	Name	Function
4	AM IN	Press to display the Amplitude Modulation setup screen. Select AM or SCM (suppressed carrier modulation). Also refer to paragraph 4.4.2 - Amplitude Modulation.
	AM In	This connector receives the modulation signal input for AM and SCM. Indicator is lit when AM or SCM is selected. Input impedance is 2.5k . For more information, refer to paragraph 4.4.2.- Amplitude Modulation.
5	SUM IN	This key allows the summing of an external signal with the selected waveform of the Model 395 and the setting of the output attenuators. For details, check the paragraph 4.4.14.
	Sum In	This is the input connector for the external summing signal. Input impedance is 600
6	MAIN OUT	This key enables or disables the MAIN OUT connector. Output impedance is 50 .
	Main Out	This connector supplies the waveform output signal. A lit indicator signifies the output is turned ON. Output impedance is 50 . Output level is up to 10 Vp-p into 50 termination.



**Figure 4-5. Knob and Cursor**

**Table 4-4. Connectors and Control Keys**

Ref	Name	Function
1	Cursor keys	Pressing the cursor keys moves the cursor position to the left (<-) or to the right (->). The knob changes values of the digit positioned over the cursor. The cursor keys can also be used to scroll additional screen items.
2	Knob	Use the knob to change numeric values and to scroll through items displayed on the screen. Clockwise rotation increases the value. Counter clockwise rotation decreases the value. When menus contain additional items, as indicated by a double-head arrow, use the knob to display additional screens.



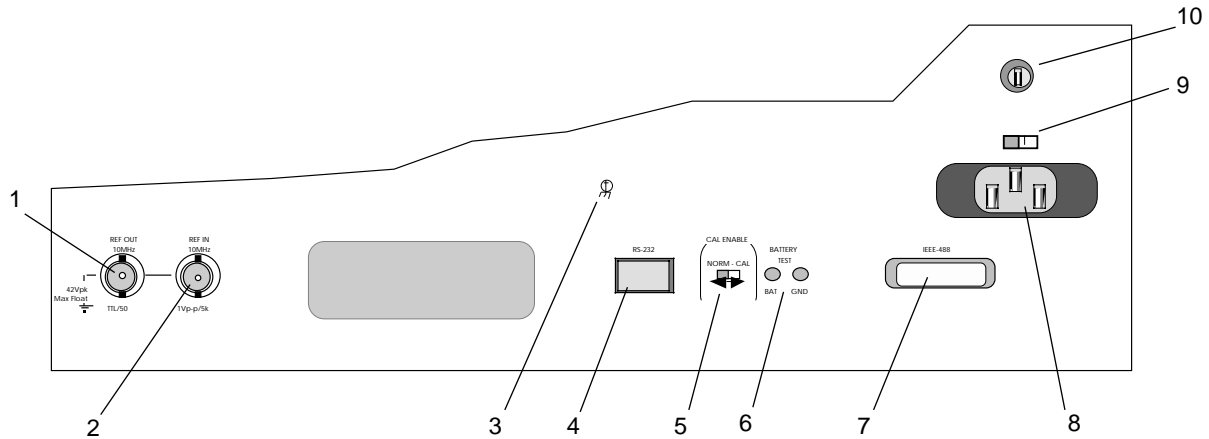
**Figure 4-6. Numeric Keys Group**

**Table 4-5. Numeric Keys Group**

Ref.	Name	Function
1	<- BSP	Backspace moves the cursor left one character and deletes that character.
2	RESET	Use this key to reset all parameters to default values, to delete Arbitrary waveforms, or to delete all stored setups and DSO drivers.
3	REMOTE	Use this key to select a remote interface and to set up interface parameters. Refer to paragraph 4.4.8.
4	MAN TRIG	Press to this key to manually trigger the generator. Refer to paragraph 4.4.17 - Triggering.
5	Number keys	Use these keys to enter numeric values.
6	EXP	Use this key to enter an exponential value. Numbers entered after EXP are treated as exponents.
7	CLEAR	Use to erase an entire entry. Press ENTER to restore to last legal entry.

### 4.3 REAR PANEL

Figure 4-7 illustrates the rear panel of the Model 395. Numbers in this figure identify the connectors described in table 4-6.






**Figure 4-7. Rear Panel Connectors**

**Table 4-6. Rear Panel Connectors**

Ref	Name	Function
1	REF OUT	This connector provides a buffered 10 MHz TTL internal system clock output. Also, this connector can supply a buffered reference output with an external 10 MHz clock connected to REF IN. Output signal level is approximately 1.5 Vp-p into 50 . Also refer to paragraph 4.4.5 for additional information.
2	REF IN	Use this connector as an optional external reference source input. Input frequency must be 10 MHz ±5%. Input level must be between 1Vp-p and 10 Vp-p with 40 to 60% duty cycle. Input impedance is >1k (ac coupled). Also refer to paragraph 4.4.5 for additional information.
3	Earth Gnd.	Earth ground connection.
4	RS-232	Use this connector to connect the Model 395 to a computer for remote operation. For more information on RS-232 interface and its operation, refer to paragraph 2.7.1 and section 5 of this manual.
5	CAL ENABLE	<b>IMPORTANT</b> - This switch is normally covered by a Calibration Sticker. Only personnel authorized to perform a calibration procedure should remove this sticker. An improperly performed calibration procedure could severely affect the performance of this instrument. Use this switch to enable or disable the Model 395 internal calibration procedure. The switch should be in the NORM position during normal operation. Change the switch to CAL when performing calibration.

**Table 4-6. Rear Panel Connectors (Continued)**

Ref	Name	Function						
6	BATTERY TEST	Use these test points to measure the internal battery of the Model 395. A normal battery should measure between + 3.2 and +2.7 Vdc.						
7	IEEE-488	Optional - Use this connector to connect the Model 395 to a computer for remote operation or a digital storage oscilloscope (DSO) for direct DSO Waveform Transfer. For more information on IEEE-488 interface and its operation, refer to paragraph 2.7.2 and section 5 of this manual. For information on DSO waveform transfer, refer to appendix F.						
8	Power Con. 	Use this connector to connect the Model 395 to the ac supply. ALWAYS ENSURE THAT THE INSTRUMENT IS CONNECTED TO EARTH/PROTECTIVE GROUND. SEE SAFETY ISSUES SECTION AT THE FRONT OF THIS MANUAL.						
9	Line Voltage 	Use this switch to select the line voltage to match the primary power source. SEE SECTION TWO AND THE SAFETY ISSUES SECTION AT THE FRONT OF THIS MANUAL. <table border="1"> <thead> <tr> <th>Switch Setting</th> <th>Voltage Range</th> </tr> </thead> <tbody> <tr> <td>115 (Vac)</td> <td>90 to 132 Vac</td> </tr> <tr> <td>230 (Vac)</td> <td>198 to 252 Vac</td> </tr> </tbody> </table>	Switch Setting	Voltage Range	115 (Vac)	90 to 132 Vac	230 (Vac)	198 to 252 Vac
Switch Setting	Voltage Range							
115 (Vac)	90 to 132 Vac							
230 (Vac)	198 to 252 Vac							
11	Fuse 	The Model 395 primary power fuse. SEE SECTION 2 AND THE SAFETY ISSUES SECTION AT THE FRONT OF THIS MANUAL. <table border="1"> <thead> <tr> <th>Line Voltage</th> <th>Fuse</th> </tr> </thead> <tbody> <tr> <td>115</td> <td>1 A Time delay</td> </tr> <tr> <td>230</td> <td>0.5 A Time Delay</td> </tr> </tbody> </table>	Line Voltage	Fuse	115	1 A Time delay	230	0.5 A Time Delay
Line Voltage	Fuse							
115	1 A Time delay							
230	0.5 A Time Delay							

---

## 4.4 REFERENCE

These paragraphs are organized by front panel keys in alphabetical order.

<b>Paragraph Number</b>	<b>Subject</b>
4.4.1	Amplitude
4.4.2	AM In (Amplitude Modulation)
4.4.3	Arbitrary Waveforms
4.4.4	Filter
4.4.5	Frequency
4.4.6	Mode
4.4.7	Offset
4.4.8	Remote
4.4.9	Reset
4.4.10	Sequence
4.4.11	Setups
4.4.12	Standard Waveforms
4.4.13	Status
4.4.14	Sum In (Summing)
4.4.15	Sweep
4.4.16	Sync Out
4.4.17	Trigger
4.4.18	Utility

### 4.4.1 AMPLITUDE

Amplitude controls the voltage level of the signal from the MAIN OUT connector. Amplitude is variable between -10.0 Vp-p and +10.0 Vp-p into 50  $\Omega$  in 10 mV steps with 3 digits of resolution. A negative “-” amplitude means the signal is inverted relative to the Sync Out signal.

The Model 395 displays Amplitude in units of Vp-p, Vp, Vrms, or dBm. Maximum levels depend on the programmed waveform and units selected; see table 4-7.

The amplitude of Arbitrary waveforms and waveform sequences depend on the data values entered while creating the waveform. Thus, the actual amplitude output for Arbitrary waveforms and waveform sequences may be less than the programmed amplitude.

**Table 4-7. Maximum Amplitude Vs Waveform**

Waveform	Vp-p	Vp	Vrms	dBm
Sine	10.0	5.00	3.54	+24.0
Square	10.0	5.00	5.00	+27.0
Triangle	10.0	5.00	2.89	+22.2
+Ramp	10.0	5.00	2.89	+22.2
-Ramp	10.0	5.00	2.89	+22.2
sin (x)/x	10.0	5.00	NA	NA
+H-Sine	10.0	5.00	1.77	NA
-H-Sine	10.0	5.00	1.77	NA
Random	10.0	5.00	5.00	NA
Pulse	±5.00V Upper level (Offset - lower level)			
Pulse Train baseline)	±5.00V Pulse level each pulse. Offset -			
Digital Noise	10.0	5.00	NA	NA
Analog Noise	10.0	5.00	NA	NA
Comb	10.0	5.00	NA	NA
Sig. + Noise	10.0	5.00	NA	NA
Sig. + Comb	10.0	5.00	NA	NA
AM	10.0	5.00	NA	NA
FM	10.0	5.00	NA	NA
Arb Waveform	10.0	5.00	NA	NA
Sequence	10.0	5.00	NA	NA

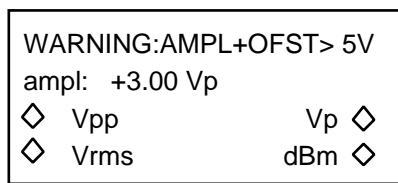
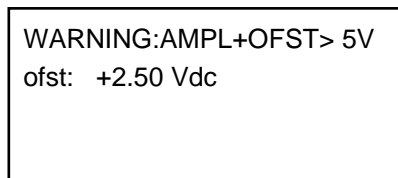
Notes

All values measured into 50 termination

NA - Not Available

**Amplitude + Offset Limits**

If Amplitude plus Offset exceeds 5Vp, the screen will display an error message:



The upper screen will be displayed when Offset is selected; and the lower screen when Amplitude is selected. To correct the problem, change the amplitude value or the offset values.

**Programming Amplitude**

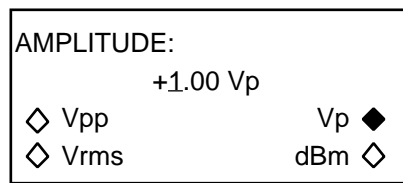
To program Amplitude (see figure 4-8), press the AMPLITUDE key which displays the Amplitude screen. Change the value using the knob or keypad. Changing the sign of the output level inverts the waveform relative to the Sync Out signal. Changing the amplitude sign in dBm does not invert the waveform but will affect the output level.



---

To change voltage units, press these softkeys:

Vp-p	F3
Vrms	F4
Vp	F7
dBm	F8



---

**Figure 4-8. Amplitude Programming**

### **Vp-p**

“Vpp” (voltage peak-to-peak) displays the output as the level between the positive and negative peaks of the waveform.

### **Vrms**

“Vrms” displays voltage root-mean-square value of the waveform. Not all waveforms display amplitude in Vrms.

### **Vp**

“Vp” displays the maximum peak value of the waveform.

### **dBm**

“dBm” displays output amplitude levels in decibels above 1 milliwatt. Not all waveforms display amplitude in dBm.

### **Also see:**

Paragraph 4.4.7    Offset

---

## 4.4.2 AM IN (AMPLITUDE MODULATION AND SCM)

The Model 395 supports Amplitude Modulation (100%) and Suppressed Carrier Modulation (200%). The unit receives its modulating signal via the AM IN connector. An external signal controls the level of the signal at the MAIN OUT connector. All waveforms, including arbitrary waveforms, can be modulated. Amplitude modulation works in all operating modes. Figure 4-9 illustrates the AM In screen.

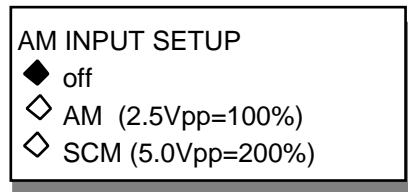


Figure 4-9. AM In Screen

### Note

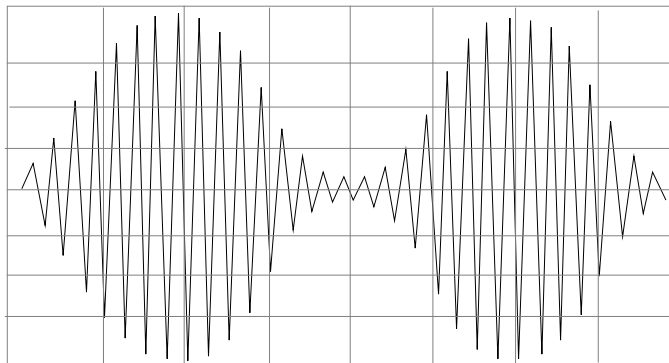
The Model 395 also provides internal AM and SCM which is accessible through the Standard Waveform's screens. See paragraph 4.4.12.18.

### OFF

Press F2, "off," to disconnect the AM Input from the Model 395. See figure 4-9.

### AM (Amplitude Modulation)

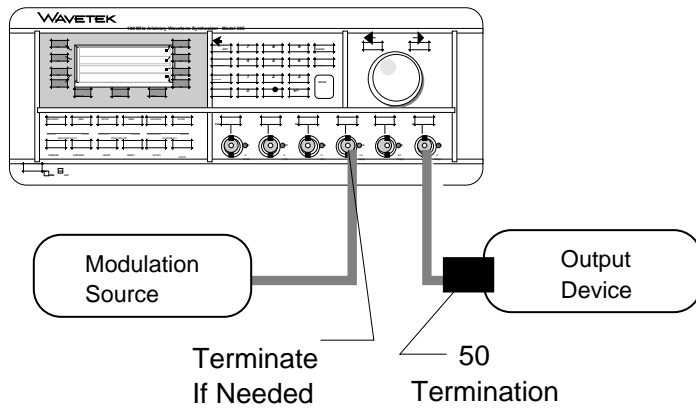
An input of 2.5 V<sub>p-p</sub> produces 0% to 100% modulation of the programmed amplitude. In other words a +1.25V input produces 100% programmed amplitude, and -1.25V input outputs 0% programmed amplitude. With a 0V modulating signal, the MAIN OUT signal is half the programmed amplitude.



To Amplitude Modulate the Model 395,

- Select the Waveform;
- Program the frequency;
- Program the Amplitude;
- Set up the operating Mode.

Press the AM IN key and select (F3) "AM (2.5Vpp=100%)." Connect the modulating source to the AM IN connector (figure 4-10).



**Figure 4-10. AM/SCM Setup**

**NOTE**

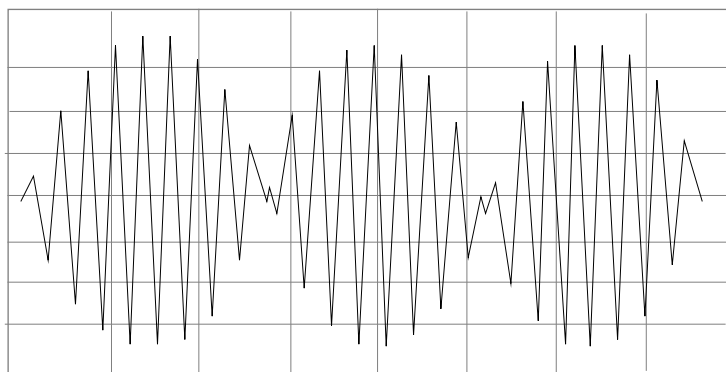
Failing to properly terminate the Modulation Source at the AM IN connector could cause inaccurate modulation levels.

**Also see:**

- Amplitude
- MAIN OUT
- Frequency
- Mode

**SCM (Suppressed Carrier Modulation)**

SCM produces an output whose level is dependent on the modulation input signal. With 0V input or no modulation input, the MAIN OUT signal is 0Vp-p. For full programmed output, drive the AM IN with 2.5V. +2.5V produces an in phase output, and -2.5V generates an out of phase output.



---

To SCM the Model 395,

- Select the Waveform;
  - Program the frequency;
  - Define the Amplitude;
  - Set up the operating Mode.
- Press the AM IN key and select (F4) “SCM (5V<sub>pp</sub>=200%).” Connect the modulating source to the AM IN connector (figure 4-10).

Also see:

- Amplitude
- MAIN OUT
- Frequency
- Mode

### 4.4.3 ARBITRARY WAVEFORMS

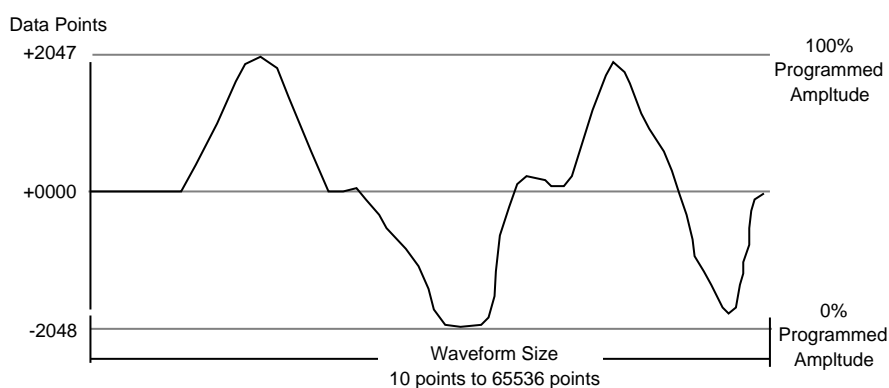
#### 4.4.3.1 Introduction

Arbitrary waveforms are individual data points at addresses stored in internal memory of the Model 395. To generate the Arbitrary waveform a clock steps the memory addresses and the data is converted to an analog voltage. The analog voltage is amplified by an output amplifier and routed to the Main Out connector. By controlling the clock period and the total number of points in each cycle, the frequency of the waveform can be increased or decreased.

In the Model 395, Arbitrary (Arb) Waveforms or user-defined waveforms can be identified by a user-defined name and number of horizontal points (waveform size): 10 to 65,536 points (256K optional). Vertical size, 4096 points (+000; -2048, +2047), represents the maximum peak-to-peak level at the programmed amplitude.

Enter waveforms using the front panel keys and screens or by sending data over the RS-232 or optional GPIB interfaces. Figure 4-11 illustrates Arb waveform parameters.

The Model 395 stores arbitrary waveforms in battery backed memory. The number of waveforms that can be stored depends on the size or the number of points in each waveform.



**Figure 4-11. Arb Waveform Basics**

---

## Arb Waveform Terms

### Horizontal Size

Number of horizontal points is the time component of the waveform. Minimum size is 10 points, and a maximum size is 65536 points (131,072 points with extended memory). The horizontal size must always be an even number.

### Waveform Address

Each horizontal point on an Arb waveform is defined by a discrete address. Addresses start at 0000 thus the ending address always appears to be one less than the number you programmed. For example, a 10 point waveform starts at 0 and ends at 9.

### Arbitrary Waveforms and Frequency

A typical Arb waveform uses only a part of memory in the Model 395. These waveforms are stored as files in the unit's memory. Each file has a name and size (number of points). The size of these waveforms combined with the scan speed (sample clock frequency) give the waveform frequency. In example 2 in section 3, the waveform, GRAY, is 2540 points long and has a period of 64  $\mu$ s. Using this information we can calculate the sample clock used by the Model 395.

Waveform Size \* Sample clock period = waveform period

Solving for Sample clock;

Sample clock period = Waveform period / Waveform size

Thus, Sample clock period = 64  $\mu$ s / 2540 points

gives, Sample clock period = 25.20 ns

or, Sample clock = 39.69 MHz.

### Data Value

Each horizontal point in an Arb waveform is defined by a discrete data or amplitude value. Data values range between -2048 and +2047 about +0000.

### Arbitrary Waveforms and Amplitude

When playing Arbitrary waveforms, the output amplitude will depend on the data values. For example, creating a waveform that contains data points ranging from -2048 to +2047 will produce an output 100% of the programmed peak to peak amplitude.

If the waveform was created using a portion of the data points, say 0000 to 2048, the output will be 50% of the programmed amplitude.

## 4.4.3.2 Creating Waveforms

Create an Arb waveform by giving the waveform a name, defining its size, and editing the waveform. Also, existing standard or arbitrary waveforms can be copied or renamed. Pressing the CREATE key displays the Create New Waveform screen; see figure 4-12. From this screen either create a new blank waveform or copy and rename an existing waveform.

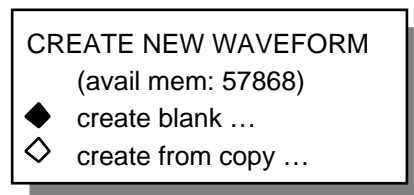


Figure 4-12. Create New Waveform

---

## Create Blank Waveforms

The CREATE screen (figure 4-13) allows you to name the new waveform and define its size; see *name* and *size* below. Selecting “create” (F8) advances to the MODIFY screen. Select “cancel” (F4) to return to the Create New Waveform screen.

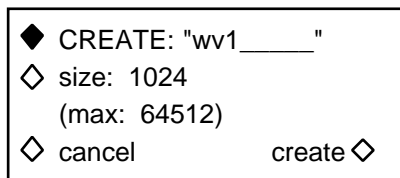


Figure 4-13. Create Blank

### Name

Enter names using the knob or numeric keypad. The Model 395 provides a default name of “wv(n)” with wv1 being the first default name. Use the knob or keypad to enter or change the name. Names can contain up to eight characters, and the characters can be alpha and numeric. The first character in the name must always be a letter.

### Size

Size (F2) defines the number of points in the waveform. Minimum number of points allowed is 10, and maximum number of points is 65536 (standard memory) or 131,072 with extended memory installed. Default is 1024 points. After selecting “size” (F3) use the keypad or knob to enter or change the number of points.

### 4.4.3.3 Create From Copy

Selecting “create from copy” duplicates an existing waveform and stores the copy under a new name. See figure 4-14. Hint - use create from copy to copy a standard waveform which can be edited using “Edit Waveform.”

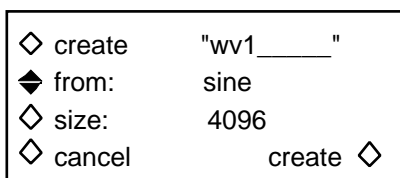


Figure 4-14. Create From Copy

---

Press F2 to select the waveform to copy. Use the knob or cursor keys to scroll through the list of waveforms stored in memory. Both standard and arbitrary waveforms can be copied.

To enter the name of the new waveform press F1 and use the knob or keypad to enter the name. Names can have up to eight characters. The first character in the name must always be a letter (a ... z).

Press F3, "size," to set the number of points in the new waveform. Minimum number of points is 10, and the maximum is 65536 points (131,072 points with extended memory). Enter the size using the knob or keypad. Default size shown is 1024 points or the amount of points left if memory is low. When the waveform is enlarged (original number of points less than new number of points), the Model 395 adds (interpolates) points. Shrinking the waveform (original number of points greater than new number of points) the Model 395 removes points from the waveform which could lose significant waveform data.

**Note**

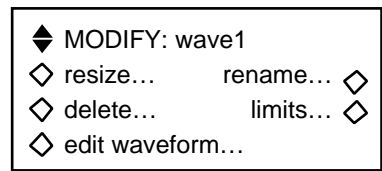
Once a waveform has been resized to a number of points less than the original size, it will never regain the same identical waveform shape as the original size.

Select "create" (F8) to accept the copied waveform and return to the Create New Waveform screen.

Select "cancel" (F4) to return to the Create New Waveform screen without copying the waveform.

#### 4.4.3.4 Modifying Waveforms

The Model 395 allows modification of existing arbitrary waveforms. See figure 4-15. Resize allows increasing or decreasing the number of points in a waveform. Rename allows you to assign the waveform a new name. "Limits" define a part of an existing waveform to output. Delete erases waveforms. Use Edit Waveform to modify waveforms using the Model 395's editing functions.



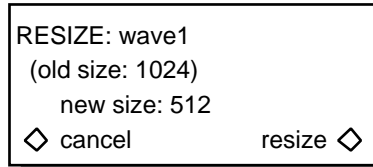
**Figure 4-15. Modify Waveforms**

Select the waveform for modification by pressing F1. Use the knob, cursor keys, or F1 to scroll through the list of arbitrary waveforms.

---

## Resize Waveform

“resize” (F2) changes the number of points in the selected waveform. Use “new size” (F3) to enter of the new size value; use the knob or keypad to enter the value. When the waveform size is enlarged, the Model 395 adds (interpolates) points. If the waveform size is shrunk, the Model 395 removes points. Reducing the size of the waveform could cause the waveform to loose significant data. See figure 4-16.



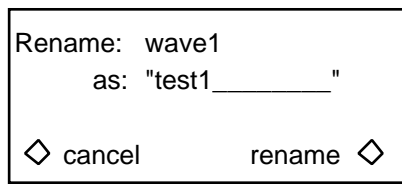
**Figure 4-16. Resize Waveform**

### Note

There is no “undo” for resize. Consider making a copy of the waveform before resizing it.

## Rename Waveform

“rename” (F6) allows changing the name of any arbitrary waveform. Names can have up to eight characters. The first character in a name must always be a letter (A ...Z). To rename a waveform, select “rename“ from the Modify screen. On the Rename screen, use the knob or keypad to enter the new name. See figure 4-17.



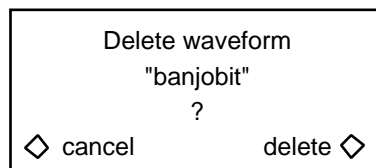
**Figure 4-17. Rename Waveform**

## Delete Waveform

“delete“ (F3) allows erasing of the selected arbitrary waveform. To delete a waveform, select the waveform (F1) from the Modify screen. Then select “delete” (F3) on the Modify screen. Select “delete” (F8) on the Delete screen to erase the waveform. Press “cancel” (F4) to return to the Modify screen without deleting the waveform. See figure 4-1.

### NOTE!

Deleted waveforms cannot be recovered.



**Figure 4-18 . Delete Waveform**



---

## Limits

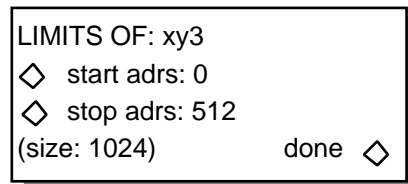
“limits” (F7) selects portions of an arbitrary waveform. To change the limits, select the addresses to “start” and “stop” the waveform. There must be at least 10 points between the start and stop address. See figure 4-19.

To set the limits, first select the waveform (F1) from the Modify screen. Next select “limits...” (F7) to display the Limits Of screen. Press “start adrs” (F2) or “stop adrs” (F3) and use the keypad or knob to change the address. Press F8 “done” to change the limits of the waveform and return to the Modify screen. From then on the waveform uses these limits until new limits are defined.

### Note

The whole waveform still exists, you have only selected a portion or “limit” of the waveform to run.

The Start address must be an even number, and the Stop address must be an odd number.

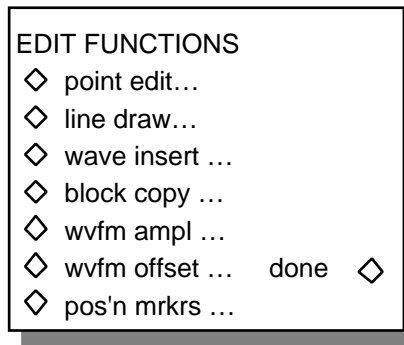


---

**Figure 4-19. Waveform Limits**

## Edit Waveform

Select “edit waveform ...” to modify a waveform (see figure 4-20) by changing one point at a time (point edit), by drawing lines between two points (line draw), or by inserting all or part of an existing waveform (wave insert) into the selected waveform. In addition, portions of the waveform can be selected and the peak to peak level changed using waveform amplitude, or baseline adjusted using waveform offset. Plus, copy portions of a waveform and insert the copy within the same waveform. Also, from this screen define position markers for use as Sync Output.

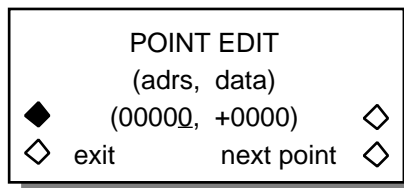


**Figure 4-20. Waveform Edit**

*(actual screen will display only four lines at a time)*

### Point Edit

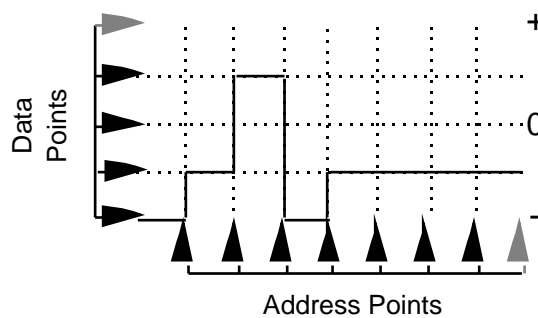
“point edit” programs the data value at a single point in the waveform. See figure 4-21. To modify a point, select “address” (F3) and use the knob or keypad to enter the address to be changed. Change the data by selecting “data” (F7) and using the knob or keypad to enter the desired data value (+0000; -2048, +2047). Changing the data value automatically updates the waveform.



**Figure 4-21. Point Edit**

Selecting “next point” (F8) automatically advance to the next address. Select “exit” (F4) to return to the Select Edit Waveform screen without advancing to the next address.

Figure 4-22 illustrates an example of point edit. Also, paragraph 3.7, example 5 demonstrates the point edit.



**Figure 4-22. Point Edit Illustration**

---

## Line Edit

“line edit” draws a line between two points in an Arb waveform. Line edit requires the user to enter address and data values for the first, “fm,” point and the last, “to,” point of the line. See figure 4-23.

To use line edit, select the “fm adrs” (F2) and enter the value. Select from data (F6) and enter the value. Next, select the “to adrs” (F3) and enter the value, and select to data (F7) and enter the value (+0000; -2048 to +2047). Use the knob or keypad to change values. The Model 395 automatically swaps the two addresses if the “from” address is less than the “to” address.

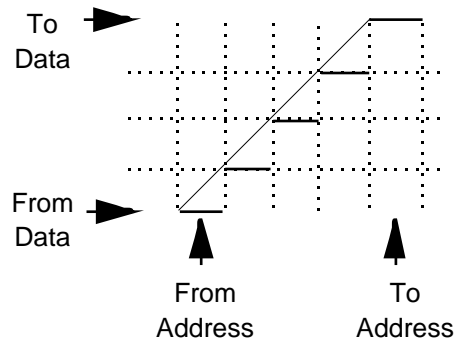
---

LINE	(adrs ,data)
◇ fm:	(000000 ,+2058) ◇
◇ to:	(000200 ,+0000) ◇
◇ exit	draw line ◇

---

**Figure 4-23. Line Draw**

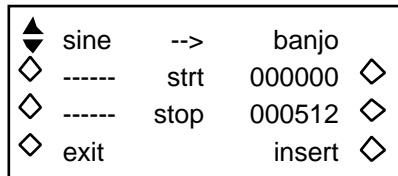
Select “draw line” to draw the line segment between the “to” and “from” points. Select “exit” to return to the Edit Waveform screen. Selecting Exit does not draw a line. Figure 4-24 illustrates an example of line draw. Also, paragraph 3.7, example 2 demonstrates the line draw technique.



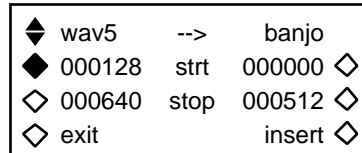
**Figure 4-24 . Line Draw Illustration**

## Wave Insert

Wave Insert places waveforms between programmable start and stop points. Both standard and arbitrary waveforms can be inserted in the new waveform. These waveforms cannot be used with waveform insert: pulse, pulse-train, digital noise, analog noise, comb, signal plus noise, signal plus comb, AM, FM, and sequence. Portions of arbitrary waveforms can be selected (start and stop points) and inserted in the waveform. Figure 4-25a illustrates the standard waveform insertion screen, and figure 4-25b illustrates the arbitrary waveform insertion screen. Paragraph 3.7, example 4 demonstrates the waveform insert technique.



**Figure 4-25a. Insert Standard Waveforms**



**Figure 4-25b. Insert Arbitrary Waveform**

Select the waveform to be inserted by pressing F1, and use the knob, cursor, or F1 key to scroll through the list. The displayed waveform is inserted into the new waveform by pressing F8, “insert.”

Start and stop points define where to insert the selected waveform into the new waveform. Select “start” (F6) to change the start point and “stop (F7) to change the stop point. Use the knob or keypad to enter the address values. Minimum size between start and stop points is 10 points.

If you choose an arbitrary waveform (figure 4-25b), you can insert portions of the selected waveform into another waveform. Select the start point (F2) and the stop point (F3) which represents the portion of the existing waveform you want to insert between the start and stop points of the new waveform. If there is a size difference between the two waveforms, the Model 395 expands or shrinks the waveform to fit. Shrinking the waveform may lose some data points at the end of the waveform. To insert portions of the current waveform within itself, use Block Copy.

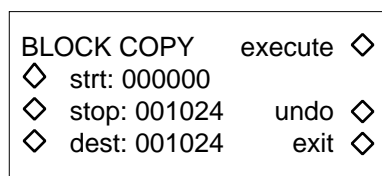
Select “insert” (F8) to insert the selected waveform into the edited waveform. You can insert as many waveforms as will fit.

Select “exit” (F4) to leave waveform edit and return to the Edit Waveform screen.

## Block Copy

Block copy allows you to select and copy part of an arb waveform and place the copy within the same waveform.

To perform a block copy of a waveform, select “block copy” from the Edit Waveform screen; see figure 4-25c.



**Figure 4-25c. Block Copy Screen**

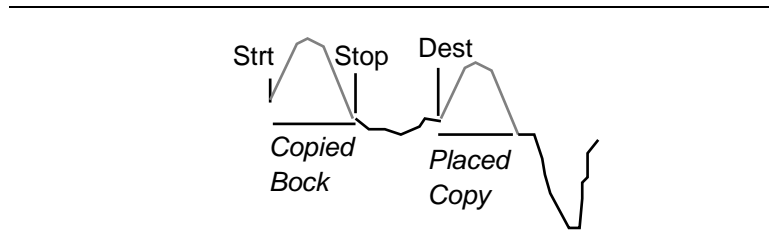
---

To define the copy block, select copy start and stop points on the waveform. Then, press F3 and use the knob, or keypad to set the copy start point To set the copy stop point, press F7 and use the knob or keypad to change the value.

Place the block copy in the waveform by first selecting the replacement (*dest*) point by pressing F4 and using the knob or keypad to enter the point. When “execute” is selected, the point from the destination point “dest” is replaced with the block copy.

To actually insert the waveform, press F5, “execute.” To return to the original waveform before block copy, press F7 “undo.” Press F8, “exit” to leave the Block Copy screen and return to the Edit Functions screen.

The copied block will be placed after the destination (insertion) point . Any points that run beyond the end of the end of the original waveform will be lost. If the block data overlaps the destination point the Model 395 will properly handle the data.

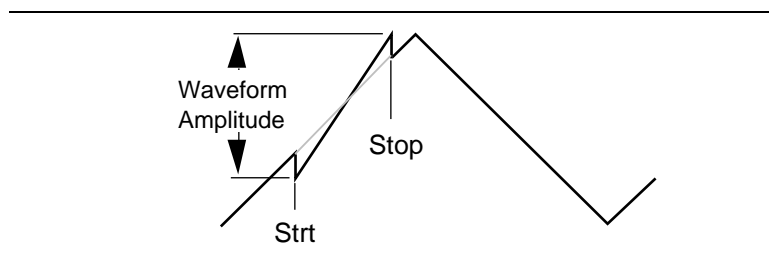


**Figure 4-25d. Block Copy**

### Waveform Amplitude

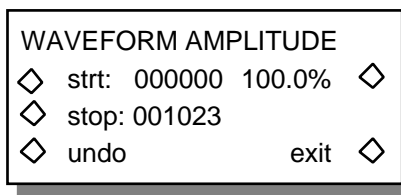
Waveform amplitude (displayed as “wvfm ampl ...”) allows you to select a portion of the waveform and change the peak to peak amplitude of that part of the waveform.

Waveform amplitude is the percentage of the selected peak to peak level relative to the overall vertical size (see figure 4-25e). Maximum percentage is 100.0% and minimum percentage is 0.0% with a 0.1% resolution. If the waveform portion is originally 100%, the waveform portion can only be reduced. But, if the waveform size is less than 100%, the selected area can be enlarged and reduced.



**Figure 4-25e. Waveform Amplitude**

When “wvfm ampl ...” is selected from the Edit Functions screen, the Model 395 displays the Waveform Amplitude screen (figure 4-25f).



**Figure 4-25f. Waveform Amplitude Screen**

**Start**

Press F2, “strt” to select the start point for waveform amplitude. Once “strt” is highlighted, use the knob, the F2 key, or the keypad the enter the value. There must be two or more points between start and stop.

**Stop**

Press F3, “stop” to select the stop point for waveform amplitude. Once “stop” is highlighted, use the knob, F3 key, or keypad the enter the value. There must be two or more points between start and stop.

**“100%”**

Press F5 to change the ratio in percent of the selected portion’s level to the relative to the maximum level. Once “100%” is highlighted, use the knob, F5, or keypad to enter a value between 0.1 and 100.0%. Changing the value does not affect the original waveform until “exit” is selected.

**exit**

Press F8, “exit” to save the changes and return to the Edit Functions screen.

**undo**

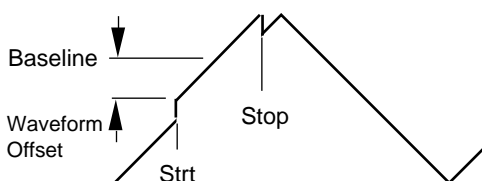
Press F4, “undo” to restore the entire original (before any changes) waveform and remain on the Waveform Amplitude screen.

**Waveform Offset**

Waveform offset (displayed as “wvfm offset ...”) allows selection of a block within the waveform and changing of the blocks baseline level (figure 4-25g). Baseline value is the average of the peak to peak values within the selected block. Changing the waveform offset does not affect the original waveform until “exit” is selected.

Model 395 inverts its output for amplitudes less than zero. Using waveform offset with inverted amplitude moves the offset opposite to the polarity shown on the screen.

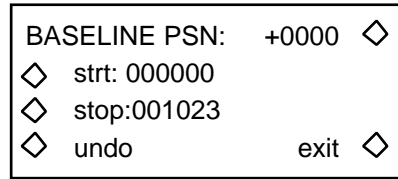
The block is offset by programming the baseline position between +2047 and -2048 points. The unit will not allow the actual block peaks to exceed the overall peaks.



**Figure 4-25g. Waveform Offset**

---

When “wvfm offset ...” is selected from the Edit Functions screen, the Model 395 displays the Waveform Offset screen (figure 4-25h).



**Figure 4-25h Waveform Offset Screen**

**Start**

Press F2, “strt” to select the start point for waveform offset. Once “strt” is highlighted, use the knob, F2 key, or keypad the vary the value. There must be two or more points between start and stop.

**Stop**

Press F3, “stop” to select the stop point for waveform offset. Once “stop” is highlighted, use the knob, F3 key, or keypad the change the value. There must be two or more points between start and stop.

**“+0000”**

Press F5 to change the baseline position (waveform offset). Once “+0000” is highlighted, use the knob, F5, or keypad to alter the value between -2048 and +2047. The baseline position does not allow the positive peak of the selected portion to exceed the portion positive peak. Also, the baseline cannot exceed the negative peak. Changing the value does not affect the original waveform.

**exit**

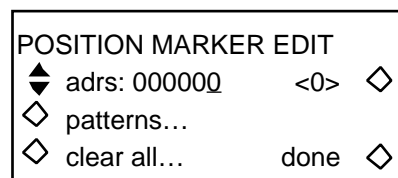
Press F8, “exit,” to save the changes and return to the Edit Functions screen.

**undo**

Press F4, “undo,” to restore the original waveform without the changes.

**Position Marker**

The position marker is a TTL signal available at the SYNC OUT. The Model 395 permits two ways of entering position markers for arbitrary waveforms: marker and marker pattern. Figure 4-26 shows the Position Marker Edit screen.



**Figure 4-26. Position Marker**

## Marker

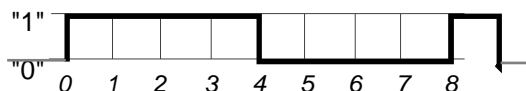
Marker allows you to create a marker pattern one point at a time. For each data point in the waveform an associated position marker can be set high or low.

First, use “adrs” (F2) to select the point address in the edit waveform. The bracketed number to the right of the address value indicates a high or low status of the marker bit. Change the marker high or low using F6.

For example enter the following addresses and point data:

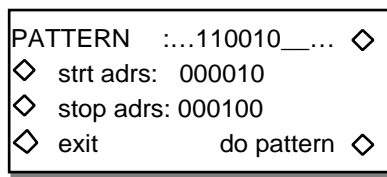
adrs:	point data
000 000	<1>
000 001	<1>
000 002	<1>
000 003	<1>
000 004	<1>
000 005	<0>
000 006	<0>
000 007	<0>
000 008	<1>

The marker:



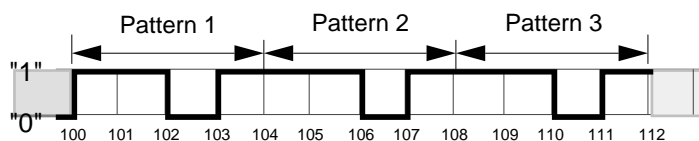
## Marker Pattern

Set marker pattern by choosing the “start” and “stop” address of a succession of markers. Enter the pattern as a series of “1s” and “0s” up to 18 characters in the pattern. Select “do pattern” to install the pattern between the “start” and “stop” addresses. The pattern will repeat from left to right as necessary to fill-in between the “start” and “stop” addresses. The initial default pattern is “1” which, when set, fills 1s in all positions between the start and stop addresses. See figure 2-27.



**Figure 2-27. Marker Pattern**

For example: Enter the following start address: 100;  
 Enter the stop address: 112;  
 Enter the pattern: 1101;  
 Select “do pattern;”  
 Select “exit” to return to the Position Marker screen;  
 Display the marker pattern:





---

### Clear All

To set all of the position marker values to low, press F4 “clear all.” You will then be asked for verification of this operation.

### NOTE

Once completed this operation cannot be undone.

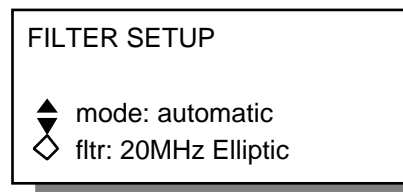
### Done

When marker editing is completed, press “done” to return to the Edit Waveform screen.

## 4.4.4 FILTER

### 4.4.4.1 Introduction

Filters remove unwanted signals that are caused by aliasing and DAC clock signals. The unit contains three low pass output filters (two elliptic filters and one Bessel filter), plus “no filter.” You can let the unit select the best filter for the conditions (Automatic), or you can choose the filter (Manual). Figure 4- 28 illustrates the filter screen that can be reached via the FILTER key.



**Figure 4-28. Filter Screen**

The elliptic filters are 8-pole filters with extremely sharp cutoffs for use when generating waveforms with relatively gentle transitions, such as sine waves and  $\sin(x)/x$  waves. The elliptic filter should not be used with waveforms with large voltage steps and sharp edges, like the square wave.

The Bessel filter is a 2-pole filter with a gradual cutoff which can be used to smooth waveforms with smooth step responses (sine wave for example). This filter should not be used with fast transitions (square wave for example), unless you want to soften the transitions.

Use *automatic* filter selection whenever possible, because using the wrong filter with the selected waveform and frequency could result in an unexpected output waveform.

### 4.4.4.2 Mode

Automatic lets the Model 395 select the best filter based on the programmed frequency, waveform, and operating mode. When automatic is selected, the filter can be temporarily changed. But, changing the frequency, waveform, or operating mode automatically selects the best filter.

Manual allows changing filters and keeps the user selected filter regardless of the frequency, waveform, or operating mode.

To switch between “automatic” and “manual” filter mode, press F3, and use the F3 key, knob, or cursor to toggle between “automatic” and “manual.”

### 4.4.4.3 Filter

The Model 395 contains three filters. The two eight pole, six-zero elliptic filters provide sharp cutoffs at 20 MHz and 40 MHz. The two-pole Bessel filter provides a less sharp cutoff at 10 MHz but a flatter overall response. “None” bypasses output filtering.

Select output filters by cycling through the list using the knob, cursor keys, or F4.

- 20 MHz Elliptic filter.
- 40 MHz Elliptic filter.
- 10 MHz Bessel filter.
- none - no filter.

## 4.4.5 FREQUENCY

Frequency programs the repetition rate for the selected arbitrary waveform, standard waveform, or sequence.

### 4.4.5.1 Standard Waveform Frequency

The Model 395 allows the setting of the repetition rate in Frequency units or Period units. See figure 4-29.

To program the frequency of a waveform, press F4, “freq” and use the knob or keypad to program the frequency. Maximum frequency depends on the selected waveform:

Waveform	Max. Freq.	Resolution
Sine and Haversines	40 MHz	10 digits 20 MHz 4 digits > 20 MHz
Triangle	10 MHz	10 digits 100 kHz 4 digits > 100 kHz
Square	50 MHz	4 digits
± Ramp /Sin (x)/x	2MHz	10 digits 100 kHz 4 digits > 100 kHz

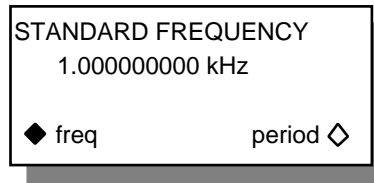


Figure 4-29. Frequency - Standard Waveforms

### 4.4.5.2 Standard Waveform Period

To program the period of a waveform, press F8, “period” and use the knob or keypad to program the value. Minimum period depends on the selected waveform:

Waveform	Min. Per.	Resolution
Sine and Haversines	25 ns	10 digits 50 ns 4 digits < 50 ns
Triangle	100 ns	10 digits 10 μs 4 digits < 10 μs
Square	20 ns	4 digits
± Ramps/Sin (x)/x	500 ns	10 digits 10 μs 4 digits < 10 μs

---

### 4.4.5.3 Arbitrary Waveforms - Frequency / Period

For arbitrary waveforms, set the “frequency” as sample clock or waveform “frequency.” See figure 4-30.

#### Sample

Selecting F3 “sample” programs the sample clock of the Arb waveform in frequency or period units; maximum sample clock frequency is 100 MHz. Also, sample clock resolution is 4 digits.

#### Waveform

Selecting F7, “waveform” (sample rate divided by number of waveform points. Minimum sample clock period is 10.00 ns,

When waveform frequency or period is selected, the Model 395 checks the number of points in the Arb waveform and “programs” the sample clock frequency need to produce that waveform and the waveform frequency or period.

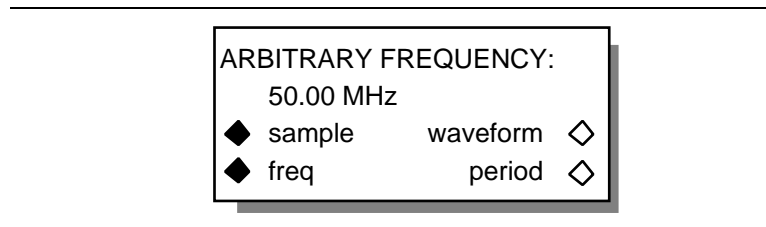


Figure 4-30. Frequency - Arbitrary Waveforms

### 4.4.5.4 Sequence - Frequency/Period

Selecting Sequence Frequency will only allow you to program the sample clock (frequency or period). Maximum clock frequency is 100 MHz, and minimum clock period is 10 ns.

### 4.4.5.5 Pulse / Pulse Train Period

Selecting pulse Frequency programs the pulse period. Minimum pulse period is 100 ns.

Selecting pulse train Frequency programs the pulse train period. Minimum period for pulse train is 100 ns.

### 4.4.5.6 Noise Clock

Frequency, while running a noise waveform, programs the sample clock (to 100 MHz) for the noise waveform. Plus, the frequency screen for analog noise, comb, signal pulse noise, and signal plus comb adjusts the start and stop Bandwidth ranges. Signal plus noise and signal plus comb frequency screens allow the programming of the signal frequency.

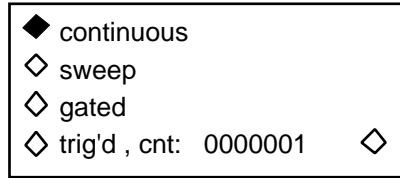
For details on noise setup and operation, refer to paragraph 4.4.12, Standard Waveforms.

---

## 4.4.6 MODE

Modes set the operating state of the Model 395. The Model 395 supports four modes of operation: continuous, sweep, gated, and triggered. The triggered and gated modes require trigger signals to activate the selected waveform; see Triggering.

To select the operating mode, press the Mode key which displays the MODE screen (figure 4-31). Select a mode from the screen using the adjacent soft keys.

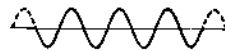


---

**Figure 4-31. Mode Screen**

### Continuous Mode

In the continuous mode the generator produces a continuous output of the selected waveform at the programmed frequency and amplitude; see figure 4-32A. Select by pressing the MODE key and selecting, “continuous,” F1.



---

**Figure 4-32A. Continuous Mode**

Also refer to

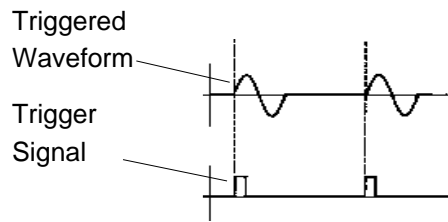
- Paragraph 4.4.12 - Standard Waveforms,
- Paragraph 4.4.3 - Arbitrary Waveforms,
- Paragraph 4.4.5 - Frequency,
- Paragraph 4.4.1 - Amplitude,
- Paragraph 4.4.7 - Offset.

### Triggered Mode

In the triggered mode, the Model 395 generates a user-defined number (cnt) of waveform cycles each time the trigger signal goes true. The output stays quiescent at the waveform baseline before receiving a true state trigger signal. The Model 395 always completes the last cycle. The number of cycles, “trig’d,cnt,” ranges from 1 (default) to 1,048,575. Both arbitrary and standard waveforms can be triggered at the programmed frequency and amplitude.

Select the triggered mode by pressing the MODE key and selecting “trig’d” (F4) from the screen (figure 4-31). Set the trigger count by pressing F8, “cnt.” Use the knob or keypad to enter the count value (1 to 1048575).

Figure 4-32B illustrates the relationship between the trigger signal and the triggered output.



**Figure 4-32B. Triggered Mode**

Baseline value for the triggered and gated modes depends on the waveform selected; see below.

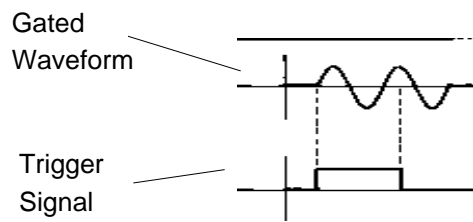
Waveform	Baseline Value
Sine	0V
Square	Negative peak
Triangle	0V
DC	0V
+Ramp	Negative peak
-Ramp	Positive peak
Sinc	0V
+Haversine	0V
-Haversine	0V
Pulse	Lower Level
Pulse Train	Baseline
Digital Noise	Negative peak
Analog Noise	Start Point
Comb	0V
Sig + Noise	Sig Dependent
Sig + Comb	0V
AM	
FM	
Arb	Waveform start address
Sequence	Start address/first waveform

### Trigger Input Setup

Trigger parameters are set up via the TRIG IN key (refer to paragraph 4.4.17). The Trig In screen allows you to select trigger source (internal, external, or manual), trigger slope (positive or negative), trigger level, and period (internal source).

### Gated Mode

In the gated mode, the Model 395 produces a continuous signal for the duration of the true trigger signal. See figure 4-33. The output is quiescent at the waveform baseline (see Triggered Mode) prior to receiving a true state trigger signal. After a true to false transition of the triggering signal, the generator runs until it completes the last full cycle before the waveform returns to its quiescent base line of the waveform. Both standard and arbitrary waveforms can be gated at the programmed frequency and amplitude.



**Figure 4-33. Gated Mode**

To select the gated mode, press the MODE key and select “gated” from the Mode screen (figure 4-31).

Note

When in the gated mode, the external slope and quiescent input level can gate the generator. For example, a negative slope (external input) with no (0V) input will gate the generator.

### Trigger Input Setup

Trigger parameters are set via the TRIG IN key (refer to paragraph 4.4.17). The Trig In screen allows you to select trigger source (internal, external, or manual), trigger slope (positive or negative), trigger level, and period (internal source).

### Sweep Mode

Sweep mode (F2) enables the conditions defined via the SWEEP OUT key (refer to paragraph 4.4.15). Parameters defined under the SWEEP OUT key are the sweep rate, sweep type, sweep mode, and start and stop frequencies. The Model 395 sweeps sine, square, triangle, +ramp, -ramp, sin (x)/x, +haversine, -haversine, random, and arb waveforms. Selecting “on” from the Sweep Out screen enables Sweep; this also enables “sweep” on the Mode screen.

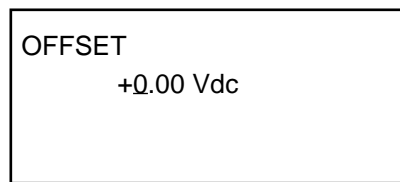
### Trigger Input Setup

For triggered sweep, set up the trigger parameters from the TRIG IN key (refer to paragraph 4.4.17). From the Trig In screen, select trigger source (internal, external, or manual), trigger slope (positive or negative), trigger level, and period (internal source).

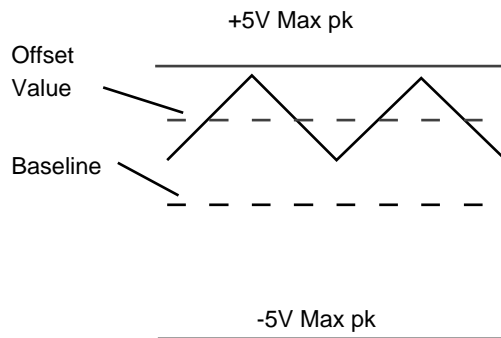
## 4.4.7 OFFSET

Offset varies the dc baseline value of a waveform relative to a 0 V point. Maximum offset range is  $\pm 5.00$  Vdc into a 50  $\Omega$  termination.

Use the OFFSET key to display the Offset screen (figure 4-34). Combined offset and amplitude cannot exceed  $\pm 5$ V. Figure 4-35 illustrates an offset triangle.



**Figure 4-34. Offset Screen**



**Figure 4-35 . Offset Triangle**

### **Offset and DC “Waveform”**

If Standard Waveform: dc is selected, use Offset to set the dc level. Amplitude will have no affect for dc.

### **Offset and Pulse**

If Standard Waveform: Pulse is selected, use Offset to set the pulse lower level. For additional information on Pulse, refer to paragraph 4.4.12.11 Standard Waveforms - Pulse.

### **Offset and Pulse Train**

If Standard Waveform: Pulse Train is selected, use Offset to set the baseline voltage for the pulse train. For additional information on Pulse, refer to paragraph 4.4.12.12 Standard Waveforms - Pulse Train.

## **4.4.8 REMOTE**

Press the REMOTE key to select and setup remote interfaces of the Model 395. The Model 395 can contain two remote interface types: RS-232 (standard) and IEEE-488 (option 001); both types are described in paragraph 5.3 and paragraph 5.4 respectively.

The Model 395 uses the SCPI commands to remotely program the unit that are covered in section 5 of this manual.

In addition, remote interfaces must be setup to upload waveforms from other sources. For uploading waveforms captured with a digital storage oscilloscope (DSO), set up the optional IEEE-488 interface - see appendix F. To use WaveForm DSP, set up the RS-232 or IEEE-488 interfaces.

---

## 4.4.9 RESET

Press the Reset key to delete all arbitrary waveforms, to delete all stored setups and DSO drivers, or to reset the Model 395 to its default values. After selecting one of the screen items, a second screen will give you a second chance before deleting the items.

### 4.4.9.1 Delete Waveforms

Selecting “delete waveforms ...” erases all arbitrary waveforms from the unit’s memory.

#### NOTE

Once a waveform is deleted, it cannot be recovered.

### 4.4.9.2 Reset Parameters

Selecting “reset parameters ...” resets the Model 395 to its default values. Arbitrary waveforms and stored settings are not affected by this selection.

#### Reset Parameters Values

Frequency	1.000000000 kHz	
Amplitude	+1.000 Vp	
Offset	+0.000 Vdc	
Mode	Continuous	
Trig Count	1	
Filter	Auto, 20 MHz Elliptic	
Waveform	Standard, Sine	
Sweep	Off	
	Range	Start: 1.000 kHz
		Stop: 10.00 kHz
	Direction	Up
	Time	1.000 sec
	Type	Continuous Sweep
		1 direction
	Trig Count	1
	Spacing	Linear
	Marker Freq	1.000 kHz
Trig In	Source	Internal
	Period	5.0000 ms
	Slope	Positive
	Level	+0.00 V
Sync	Off	
	Auto	
	Source	Waveform Sync
AM In	Off	
Sum In	Off	
Main Out	Off	

#### Delete Settings

Selecting “delete settings, DSOs...” erases all stored settings and any added DSO drivers.

#### NOTE

Once a Setting or DSO driver is deleted it cannot be recovered.



---

## 4.4.10 SEQUENCE

Sequence links together from two to four arbitrary waveforms forming complex waveforms. Sequences can run continuously or triggered, but cannot be swept or gated. Figure 4-36 illustrates the elements of sequence.



**Figure 4-36 . Sequence**

Each waveform in the sequence has its own set of parameters:

**Segment number** - waveform position in the sequence.

**Advance conditions** - how one segment advances to the next segment: loop count complete, advance trigger, or loop count complete with an advance trigger.

**Loop count** - number of times a waveform repeats.

**Limit** - portions (start and stop addresses) of a waveform run as part of the sequence.

Sequences are set up via the SEQUENCE key and Sequence Edit screens. Once defined, a sequence can run via the Sequence Edit screen or the Standard Waveform screen.

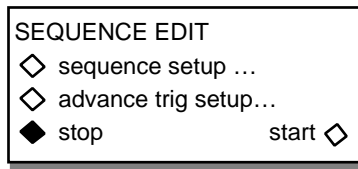
While running a sequence, you can edit Arb waveforms. If the waveform is part of the sequence, the changes appear on the scope. Arb waveforms not part of the sequence can be edited without interrupting the running sequence.

### Sequence Edit

Creating a sequence begins by pressing the SEQUENCE key which displays the Sequence Edit screen; see figure 4- 37. From this screen enter sequence parameters, plus setup the advance trigger conditions.

Hint - if the sequence is running (start), a scope connected to the unit will display any changes made to the sequence.

The Model 395 will not store a sequence. But, a sequence can be stored as an instrument setup from the SETUP key (refer to 4.4.11).



**Figure 4- 37. Sequence Setup Screen**

Press F2 to step to the Sequence Setup screen.

Press F3 to set up Advance Trigger conditions.

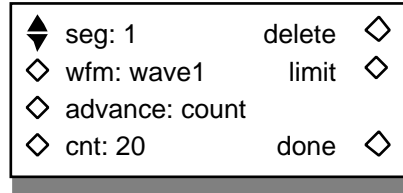
Press F8, Start, to run the sequence.

Press F4, Stop, to stop the sequence.

---

## Sequence Setup

Use this screen (figure 4-38) to select the segment, choose the waveform, and define segment advance conditions.



**Figure 4-38. Sequence Setup Screen**

## Segment

Segment identifies the waveform “position” in the sequence. Press F1, seg:, to enter the segment number between 1 and 4. A sequence must contain at least two segments. Enter the segment number using the knob, F1 key, or cursor keys. The unit allows entry of segments in any order, but the sequence will run with the segments in numerical order.

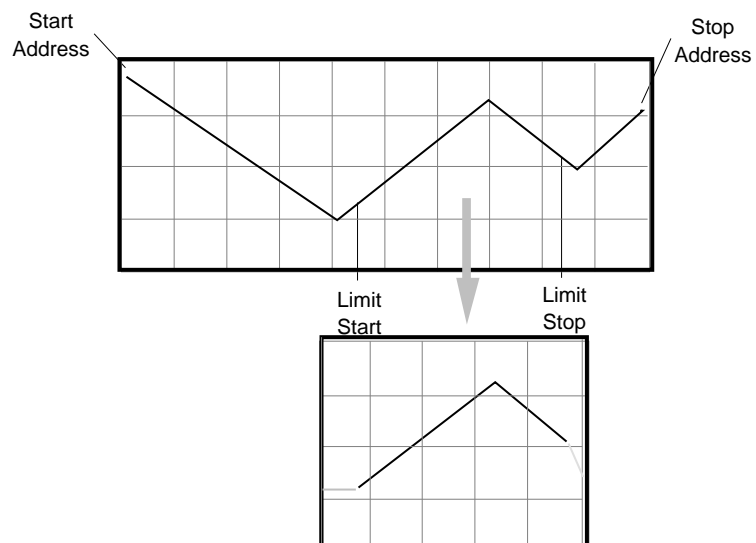
## Waveform Name

Any defined arbitrary waveform can be used in a sequence. Standard waveforms cannot be used in sequences. If the sequence is running the waveform can be viewed on a scope via the Main Out.

Press F2, wfm, to select an arbitrary waveform. If only one waveform exists the box becomes solid. When more than one arbitrary waveform exists, the hollow diamond becomes a double arrow. All Arbitrary waveforms in memory can be accessed by rotating the knob or by repeatedly pressing F2.

## Limit

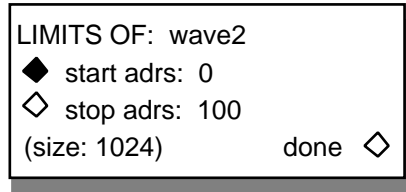
Limit selects portions (start and stop addresses) of a waveform to be run as part of the sequence. “size” displays the total size of the waveform. See figure 4-39.



**Figure 4-39. Waveform Limits**

---

Press F6, limit, to step to the limit screen; see figure 4-40.



---

**Figure 4-40. Segment Waveform Limit**

Press F2, start adrs, to enter the start address of the waveform. Start address must be less than the stop address and must be an even number.

Press F3, stop adrs, to enter the stop address of the waveform. Stop address must be greater than the start address and must be an odd number.

Press F8, done, to accept the limits and return to the sequence setup screen.

### **Advance Conditions**

Advance defines what conditions will cause the segment to advance to the next segment.

Count advances to the next segment when the loop count ends. To set the count, press F4, cnt, and use the knob or keypad to change the count value. Acceptable values are 1 to 65535.

Trigger advances to the next segment based on the parameters as defined on the Advance Trigger screen and Trigger Input screen (paragraph 4.4.17).

Count Plus Trigger advances to the next segment after the count (see count) ends and the unit receives an advance trigger (see trigger above). If the count is completed before receiving a trigger, the output remains at the last waveform point until triggered.

### **Done**

“done,” F8, accepts the setup and returns to the Sequence Edit screen.

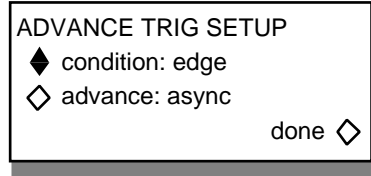
### **Delete**

Select “delete,” F5, to erase the segment from the sequence.

---

## Advance Trigger Setup

Advance trigger setup sets the advance conditions for adv: trigger and adv: count plus trig. See figure 4-41. Program the trigger source and related parameters on the Trig In screen. Done, F8, accepts trigger setup and returns to the Sequence Setup screen.



**Figure 4-41. Advance Trigger Setup Screen**

### Condition

Press F2, condition, to designate the segment advance condition. Use the knob or cursor key, as well as, the F2 key to toggle between edge and level.

Selecting “edge” advances to the next segment on the trigger signal edge which is defined from the Trigger In screen. Trigger edge can occur before the end of the segment because the Model 395 remembers a trigger occurred.

Select “level” to advance to the next segment when the level of the trigger source is true. Trigger level is defined from the Trigger In screen. The trigger source must be true and remain true until the end of the segment.

### Advance

Press F3, advance, to setup the segment advance timing. Use the knob, cursor key, or the F3 key to toggle between sync and async.

Selecting sync (synchronous) allows the waveform to complete the current cycle before advancing to the next segment.

Select async (asynchronous) to immediately advance to the next segment without waiting for the waveform to complete the current cycle.

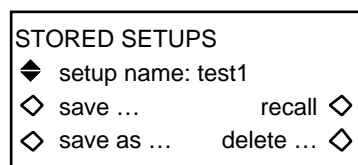
## 4.4.11 SETUPS

Setups allows the storing, recalling, and deleting of complete instrument setups. Each setup is assigned its own unique name. A setup can be automatically recalled at power up by naming the setup “startup,” and selecting “recall ‘startup’” from the Utilities “Power On Setting” screen.

### Note

A sequence can only be stored as a stored setup.

Press the SETUPS key to display the Stored Setups screen; figure 4-42.



**Figure 4-42. Stored Setup Screen**

---

## Setup Name

Press F2 to display the list of stored setups. If more than two setups are stored, the diamond changes to a double arrow. To scroll through the list, press F2 or use the knob.

## Save ...

Press F3 to save the current setup under the currently displayed setup name. This overwrites any setup using the displayed name.

## Save As ...

Press F4 to name and store the current instrument setup. Use the knob to name the setup.

## Recall

Press F7 to recall the displayed stored setup.

## Delete

Press F8 to delete the displayed stored setup.

## 4.4.12 STANDARD WAVEFORMS

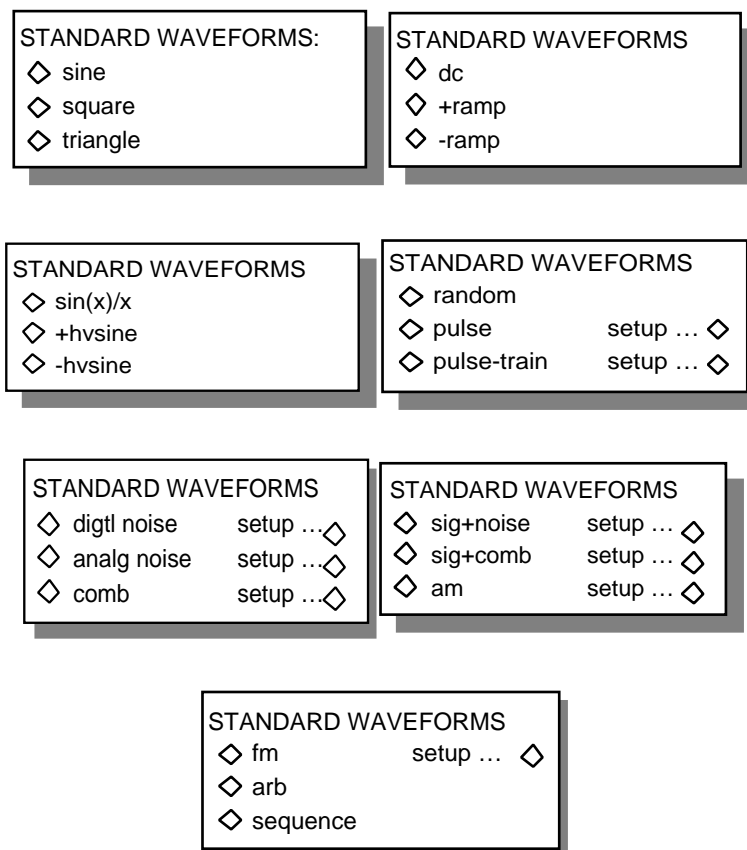
### 4.4.12.1 Introduction

Standard Waveforms are waveshapes stored in nonvolatile memory which are identifiable by common names, such as “sine”, “triangle”, or “square.” Also, the Model 395 can generate pulse, pulse train, analog noise, digital noise, comb function, signal plus noise, signal plus comb, internal AM, and internal FM waveforms, each with their own user defined parameters. These waveforms are described in these paragraphs:

Sine	paragraph 4.4.12.2
Square	paragraph 4.4.12.3
Triangle	paragraph 4.4.12.4
DC	paragraph 4.4.12.5
Positive Ramp	paragraph 4.4.12.6
Negative Ramp	paragraph 4.4.12.7
Sin(X)/X	paragraph 4.4.12.8
+Haversine	paragraph 4.4.12.9
-Haversine	paragraph 4.4.12.10
Pulse	paragraph 4.4.12.11
Pulse-Train	paragraph 4.4.12.12
Digital Noise	paragraph 4.4.12.13
Analog Noise	paragraph 4.4.12.14
Comb	paragraph 4.4.12.15
Signal + Noise	paragraph 4.4.12.16
Signal + Comb	paragraph 4.4.12.17
AM (Internal)	paragraph 4.4.12.18
FM (Internal)	paragraph 4.4.12.19
Arb Waveforms	paragraph 4.4.12.20
Sequence	paragraph 4.4.12.21

The Standard Waveform screen (figure 4-43), selected by pressing the STANDARD key, lists the standard waveforms: sine, square, triangle, dc, +ramp, -ramp, sin(x)/x, +H-sine, -H-sine, random, pulse, pulse train, digital noise, analog noise, comb, signal plus noise, signal plus comb, AM, and FM. Use the soft keys next to the waveform to select the waveform. Pulse, pulse train, digital noise, analog noise, comb, signal plus noise, signal plus comb, AM, and FM have setup screens.

Use the knob to scroll through the waveform screens. The “Arb” softkey lists all defined Arb Waveforms; see Arbitrary waveforms. The Sequence softkey starts any defined sequence. Also see Sequence.



**Figure 4-43. Standard Waveform Screens**

#### 4.4.12.2 Sine

The Model 395 produces a sinusoidal waveform programmable between 1  $\mu$ Hz and 40 MHz.

#### 4.4.12.3 Square

The Model 395 produces a square waveform programmable between 1  $\mu$ Hz and 50 MHz.

#### 4.4.12.4 Triangle

The Model 395 produces a triangle waveform programmable between 1  $\mu$ Hz and 10 MHz.

#### 4.4.12.5 DC

“dc” (direct current) waveform allow the Model 395 to produce a dc output voltage of  $\pm 5.00$  Vdc into 50  $\Omega$ . To program the dc voltage, press the OFFSET key and use the knob or keypad to adjust the level.

---

#### 4.4.12.6 Positive Ramp

The Model 395 produces a positive-going ramp programmable between 1  $\mu$ Hz and 2 MHz.

#### 4.4.12.7 Negative Ramp

The Model 395 produces a negative-going ramp programmable between 1  $\mu$ Hz and 2 MHz.

#### 4.4.12.8 Sin(X)/X

The Model 395 produces a Sin(X)/X waveform programmable between 1  $\mu$ Hz and 1 MHz.

#### 4.4.12.9 Positive Haversine

The Model 395 produces a positive-going haversine waveform programmable between 1  $\mu$ Hz and 40 MHz.

#### 4.4.12.10 Negative Haversine

The Model 395 produces a negative-going haversine waveform programmable between 1  $\mu$ Hz and 40 MHz.

#### 4.4.12.11 Pulse

The Model 395 allows you to program a pulse pattern with independent variable rise and fall times, adjustable delay and width times, and programmable levels. The Frequency key sets the pulse repetition period. The Amplitude key programs the upper level of the pulse, and the Offset key programs the lower level of the pulse. Figure 4-44 defines pulse parameters.

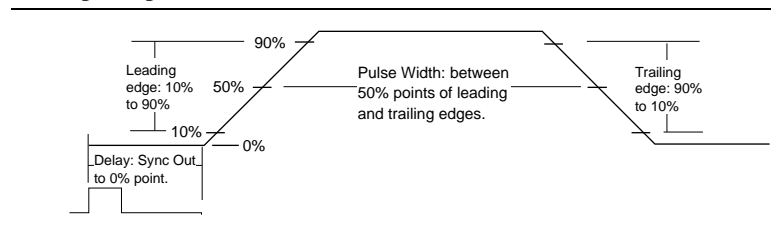


Figure 4-44. Pulse Parameters

#### Pulse Setup

To begin defining pulse parameters, select “pulse setup” from the Standard Waveform screen; see figure 4-45. The following paragraphs lead you through the pulse setup screens. For an example of pulse setup, refer to paragraph 3.12, example 10.

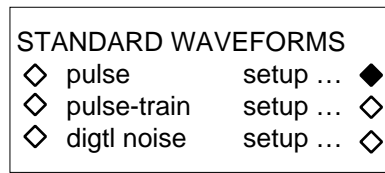
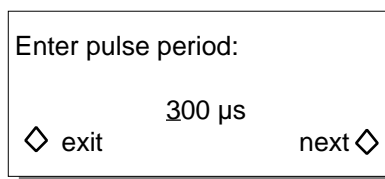


Figure 4-45. Standard Waveforms - Pulse Setup

---

## Pulse Period

After selecting “pulse setup,” the Pulse Period screen appears; see figure 4-46.

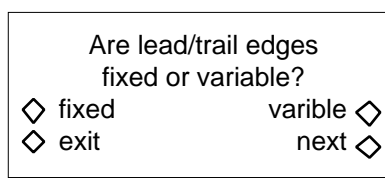


**Figure 4-46. Pulse Period Screen**

This screen allows you to program the period of the pulse. Pulse period can be programmed between 100 ns and 655 ks using the knob or keypad. Press F8, “next” to advance to the Lead/Trail Edge screen. Or, press F4, “exit,” to return to the Standard Waveform screen. When “pulse” is selected on the Standard Waveform screen, the Frequency key and screen can be used to change the pulse period.

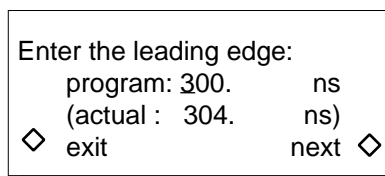
## Leading / Trailing Edge

This screen (figure 4-47) allows you to choose between a fixed leading and trailing edge (<8 ns) or a variable trailing edge.



**Figure 4-47. Leading / Trailing Edge**

Pressing F8, “next,” advances to the Leading Edge screen. Or, press F4, “exit,” to return to the Standard Waveform screen.



**Figure 4-48. Leading Edge Screen**

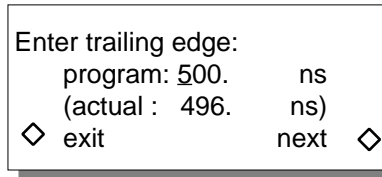
This screen allows you to program the leading edge of the pulse. The Leading Edge screen only appears if Leading / Trailing Edge: variable was selected on the previous screen.

Use the knob or keypad to enter the “program” value. For pulse periods < 655 μs, the edge is programmable between 50 ns and 500 μs. For pulse periods > 655 μs, the edge is programmable between 0.1% and 79% of the pulse period. The screen displays the actual leading edge value which may be different from the programmed value based on the overall pulse parameters.



---

Pressing F8, “next,” advances to the Trailing Edge screen (see figure 4-49). Or, press F4, “exit,” to return to the Standard Waveform screen.

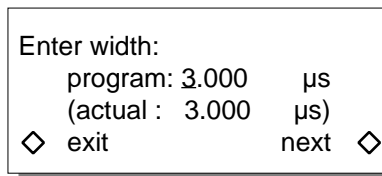


**Figure 4-49. Trailing Edge Screen**

This screen allows you to program the trailing edge of the pulse. The Trailing Edge screen only appears if Leading / Trailing Edge: variable was selected.

Use the knob or keypad to enter the “program” value. For pulse periods < 655  $\mu$ s, the edge is programmable between 50 ns and 500  $\mu$ s. For pulse periods > 655  $\mu$ s, the edge is programmable between 0.1% and 79% of the pulse period. The screen displays the actual trailing edge value which may be different from the programmed value based on the overall pulse parameters.

Pressing F8, “next,” advances to the Width screen (see figure 4-50). Or, press F4, “exit,” to return to the Standard Waveform screen.

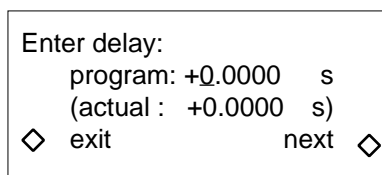


**Figure 4-50. Pulse Width**

This screen allows programming of the width of the pulse relative to the 50% points of the leading and trailing edges (figure 4-44).

Use the knob or keypad to enter the “program” value. For pulse periods < 655  $\mu$ s, the width is programmable between 10 ns and 655  $\mu$ s. For pulse periods > 655  $\mu$ s, the width is programmable between 0.002% and 99.9% of the pulse period. The screen displays the actual width value which may be different from the programmed value based on the overall pulse parameters.

Press F8, “next,” to advance to Delay screen (see figure 4-51). Or, press F4, “exit,” to return to the Standard Waveform screen.



**Figure 4-51. Pulse Delay**

This screen allows programming of the pulse delay relative to the Sync Out signal (figure 4-44).

Use the knob or keypad to enter the “program” value. For pulse periods  $< 655 \mu\text{s}$ , the delay is programmable between  $-600 \mu\text{s}$  and  $+600 \mu\text{s}$ . For pulse periods  $> 655 \mu\text{s}$ , the width is programmable between  $-99.9\%$  and  $+99.9\%$  of the pulse period. The screen displays the actual delay value which may be different from the programmed value based on the overall pulse parameters.

Press F4, “exit,” to return to the Standard Waveform screen. The “next” key, F8, returns to the Pulse Period screen.

#### 4.4.12.12 Pulse Train

A pulse train can contain up to ten pulses. Each pulse (index) can have its own rise/fall time, delay/width, and pulse level. Position of the pulses in the pattern are determined by their delay and not the index number because the pulse pattern is relative to the Sync signal.

From the Standard Waveform screen, select “pulse train” to generate a pulse train setup via “pulse train setup ...”

Selecting “pulse train setup” allows you to redefine pulse parameters. Figure 4-52 defines pulse train parameters.

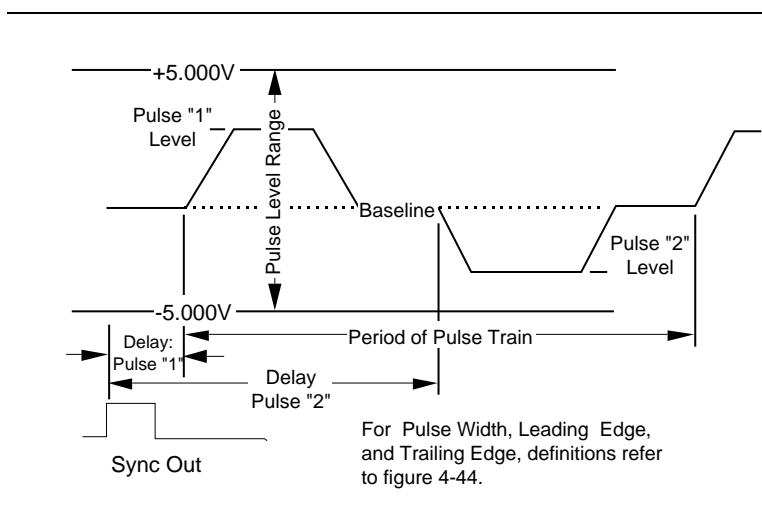


Figure 4-52. Pulse Train Parameters

#### Pulse Train Setup

To begin defining pulse train parameters, select “pulse-train setup” from the Standard Waveform screen; see figure 4-53. The following paragraphs lead you through the pulse train setup screens. For an example of pulse train setup, refer to paragraph 3.12, example 11.

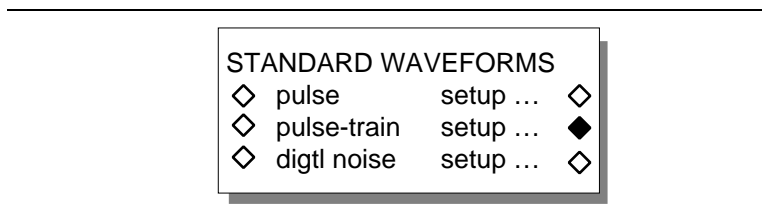


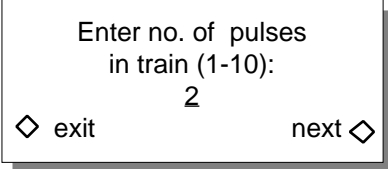
Figure 4-53. Standard Waveform Screen

---

## Number of Pulses

This screen (see figure 4-54) allows you to define the number of pulses in the pulse train. Use the knob or keypad to program the number (1 and 10 pulse - default = 2).

---



Enter no. of pulses  
in train (1-10):  
2  
◇ exit                      next ◇

---

**Figure 4-54. Pulses In Train Screen**

### Note:

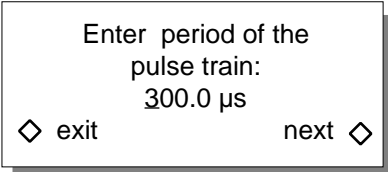
pulse position in the pulse train is defined by the delay time relative to the sync out signal not the number of the pulse.

Press F8, “next,” to advance to the Pulse Train Period screen. Or, press F4, “exit,” to return to the Standard Waveform screen.

## Pulse Train Period

The Pulse Train Period screen (figure 4-55) allows you to program the period of the pulse train.

---



Enter period of the  
pulse train:  
300.0 μs  
◇ exit                      next ◇

---

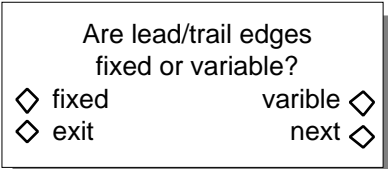
**Figure 4-55. Pulse Train Period Screen**

Pulse train period can be programmed between 100 ns and 655 ks using the knob or keypad. When “pulse-train is selected on the Standard Waveform screen, the Frequency key and screen can be used to change the pulse train period. Press F8, “next” to advance to the Lead/Trail Edge screen. Or, press F4, “exit,” to return to the Standard Waveform screen.

## Leading / Trailing Edge

This screen (figure 4-56) allows you to choose between a fixed leading and trailing edge (<8 ns) or a variable trailing edge. This selection affect all pulses in the pulse train.

---



Are lead/trail edges  
fixed or variable?  
◇ fixed                      variable ◇  
◇ exit                      next ◇

---

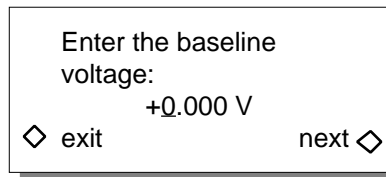
**Figure 4-56. Leading / Trailing Edge**

Pressing F8, “next,” advances to the Baseline screen. Or, press F4, “exit,” to return to the Standard Waveform screen.

---

## Baseline

The Baseline screen (figure 4-57) allows you to set the reference level for the pulse train.

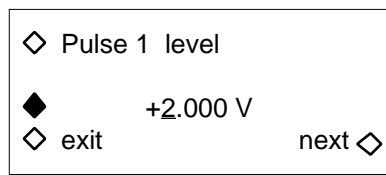


**Figure 4-57. Baseline Screen**

Use the knob or keypad to program the value which is programmable between -5.000V and +5.000V. When “pulse” is selected on the Standard Waveform screen, the Offset key and screen can be used to change the Baseline level. Press F8, “next” to advance to the Pulse Level screen. Or, press F4, “exit,” to return to the Standard Waveform screen.

## Pulse Level

The Pulse Level screen (figure 4-58) permits you to set the absolute level of the pulse.



**Figure 4-58. Pulse Level Screen**

Use the knob or keypad to program the level of the selected pulse between -5.000 V and +5.000 V. To change the Pulse Level of other pulses in the train, press F1 or rotate the knob until the number of the desired pulse appears. F3 must be pressed before the pulse level can be programmed.

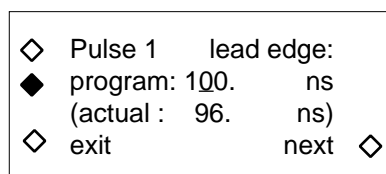
### Note

When “pulse-train” is selected on the Standard Waveform screen, the Amplitude key and screen can be used to change the Pulse Level.

Press F8, “next” to advance to the Leading Edge screen. Or, press F4, “exit,” to return to the Standard Waveform screen.

## Leading Edge

This screen (see figure 4-59) allows you to program the leading edge of the selected pulse. The Leading Edge screen only appears if Leading / Trailing Edge: variable was selected.



**Figure 4-59. Leading Edge Screen**

---

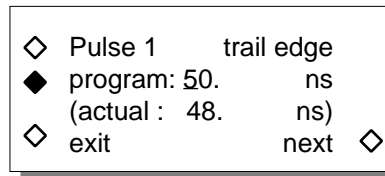
Use the knob or keypad to enter the “program” value. For pulse periods < 655  $\mu$ s, the edge is programmable between 50 ns and 500  $\mu$ s. For pulse periods > 655  $\mu$ s, the edge is programmable between 0.1% and 79% of the pulse period. If Standard Waveform: pulse train was selected before “setup,” the screen displays the actual leading edge value which may be different from the programmed value based on the overall pulse parameters.

To change the Leading Edge of other pulses in the train, press F1 or rotate the knob until the number of the desired pulse appears. F3 must be pressed before the leading edge can be programmed.

Pressing F8, “next,” advances to the Trailing Edge screen. Or, press F4, “exit,” to return to the Standard Waveform screen.

### Trailing Edge

The Trailing Edge screen (figure 4-60) allows programming the trailing edge of the selected pulse. The Trailing Edge screen only appears if Leading / Trailing Edge: variable was selected.



**Figure 4-60. Trailing Edge Screen**

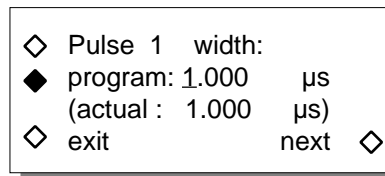
Use the knob or keypad to enter the “program” value. For pulse periods < 655  $\mu$ s, the edge is programmable between 50 ns and 500  $\mu$ s. For pulse periods > 655  $\mu$ s, the edge is programmable between 0.1% and 79% of the pulse period. If Standard Waveform: pulse train was selected before “setup,” the screen displays the actual trailing edge value which may be different from the programmed value based on the overall pulse parameters.

To change the Trailing Edge of other pulses in the train, press F1 or rotate the knob until the number of the desired pulse appears. F3 must be pressed before the trailing edge can be programmed.

Pressing F8, “next,” advances to the Pulse Width screen. Press F4, “exit,” to return to the Standard Waveform screen.

### Pulse Width

This screen (see figure 4-61) allows programming of the pulse width relative to the 50% points of the leading /trailing edges (figure 4-44).



**Figure 4-61. Pulse Width**

---

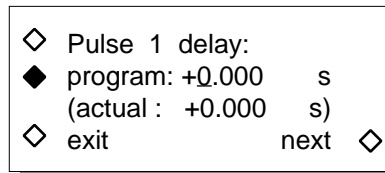
Use the knob or keypad to enter the “program” value. For pulse periods  $< 655 \mu\text{s}$ , the width is programmable between 10 ns and  $655 \mu\text{s}$ . For pulse periods  $> 655 \mu\text{s}$ , the width is programmable between 0.002% and 99.9% of the programmed pulse period. If Standard Waveform: pulse train was selected before “setup,” the screen displays the actual width value which may be different from the programmed value based on the overall pulse parameters.

To change the pulse width of other pulses in the train, press F1 or rotate the knob until the number of the desired pulse appears. F3 must be pressed before the pulse width can be programmed.

Press F8, “next,” to advance to Delay screen. Press F4, “exit,” to return to the Standard Waveform screen.

### Pulse Delay

The Delay screen (figure 4-62) allows you to program the pulse delay relative to the Sync Out signal (figure 4-44). Remember: pulse position in the pulse train is defined by the delay time relative to the sync out signal, not the number of the pulse.



**Figure 4-62. Pulse Delay**

Use the knob or keypad to enter the “program” value. For pulse periods  $< 655 \mu\text{s}$ , the delay is programmable between  $-600 \mu\text{s}$  and  $+600 \mu\text{s}$ . For pulse periods  $> 655 \mu\text{s}$ , the width is programmable between -99.9% and +99.9% of the pulse period. If Standard Waveform: pulse train was selected before “setup,” the screen displays the actual delay value which may be different from the programmed value based on the overall pulse parameters.

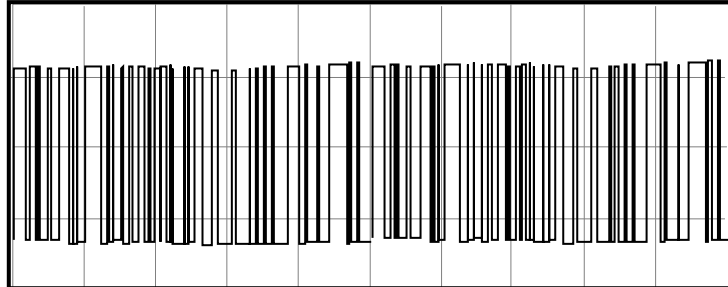
To change the delay of other pulses in the train, press F1 or rotate the knob until the number of the desired pulse appears. F3 must be pressed before the pulse delay can be programmed.

Press F8, “exit,” to return to the Pulse Level screen. From the Pulse Level screen, you can select another pulse number and then step through the parameters. Or, press F4, “exit,” to return to the Standard Waveform screen.

---

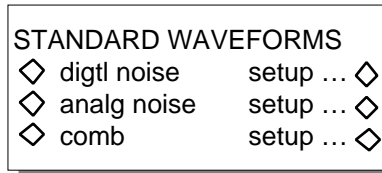
### 4.4.12.13 Digital Noise

When digital noise, “digtl noise” is selected, the Model 395 produces a random digital (0’s, 1’s) pattern with a programmable sequence length from the Main Output (see figure 4-63). Sequence length defines the repeatability of the random pattern.



**Figure 4-63. Digital Noise**

Digital noise consists of two steps (see figure 4-64). Setting the sequence length using “digtl noise setup ...,” and generating the noise pattern using “digtl noise.”



**Figure 4-64. Standard Waveform - Digital Noise**

#### Digital Noise Setup

To setup digital noise, select “digital noise setup” from the Standard Waveform screen. This displays the Sequence Length screen (figure 4-65). The selection of the sequence length determines how often the random pattern repeats from 63 to 65535 points. To vary the sequence length, press F2 to step through the listing: 63, 127, 255, 511, 1023, 2047, 4095, 8191, 16383, 32767, and 65535. With option 002, extended memory, extends the length to 131071 points. The knob can also be used to step through the listing. Press F8, “done,” to return to the Standard Waveform screen.



**Figure 4-65. Sequence Length**

#### Digital Noise

To generate digital noise, select “digtl noise” from the Standard Waveform screen; figure 4-66.

---

STANDARD WAVEFORMS			
◇	pulse	setup ...	◇
◇	pulse train	setup ...	◇
◆	digtl noise	setup ...	◇

---

**Figure 4-66. Standard Waveform Screen**

When the Model 395 builds the noise waveform the screen displays a message, see figure 4-67. This message always appears, but may only be seen during longer sequence lengths.

---

Function being built ... -----Please wait -----
---

---

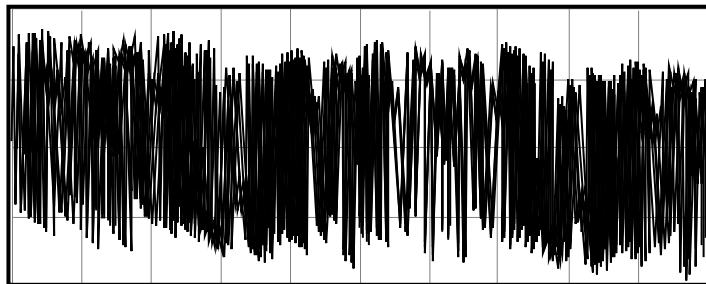
**Figure 4-66. Noise Message**

Also, while running noise, set the noise clock rate by pressing the FREQUENCY key and program the rate between 100 mHz and 100 MHz.

To vary the amplitude, press the AMPLITUDE key and enter the level in units of Vp-p or Vp. Digital noise operates in continuous, triggered, and gated modes, but cannot operate in the sweep mode.

#### 4.4.12.14 Analog Noise (White Analog Noise)

When analog noise, “analog noise” is selected, the Model 395 produces a uniform frequency distribution with programmable noise bandwidth between 0 Hz and 10 MHz with programmable sequence length from the Main Output (see figure 4-67).



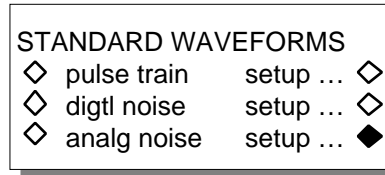
**Figure 4-67. Analog Noise**



---

## Analog Noise Setup

To setup analog noise, select “analog noise setup” from the Standard Waveform screen. This displays the Sequence Length screen (figure 4-69). The selection of the sequence length determines how often the random pattern repeats from 63 to 65535 points. Analog Noise mixes the random pattern with a bipolar Sinc waveform to produce the analog noise signal to vary the sequence length, press F2 or rotate the knob to step through the listing: 63, 127, 255, 511, 1023, 2047, 4095, 8191, 16383, 32767, and 65535. Option 002, extended memory, extends the length to 131071 points, but it takes several minutes to build the function. The knob can also be used to step through the listing. Press F8, “done,” to return to the Standard Waveform screen.



**Figure 4-68. Standard Waveform - Analog Noise Setup**

## Sequence Length

The Sequence Length screen (figure 4-69) allows the programming of the value for sequence length. Sequence length is the number of points randomly generated before the sequence pattern repeats.



**Figure 4-69. Sequence Length**

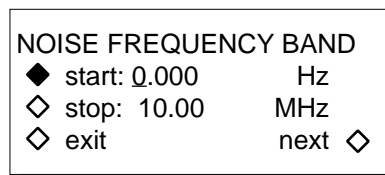
Program the sequence length by using the knob or repeatedly pressing F2 or rotating the knob. Analog noise accepts the following sequence lengths: 63, 127, 255, 511, 1023, 2047, 4095, 8191, 16383, 32767, and 65535.

After defining the sequence length, press F8, “next” to advance to the Noise Bandwidth Screen.

## Noise Bandwidth

Noise bandwidth screen allows the setting of the start and stop frequencies between 0 Hz and 10 MHz. The ratio of the start frequency to the stop frequencies must be greater than 0.9 to 1.

Press F8, “done,” to return to the Standard Waveform screen.

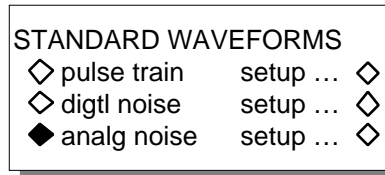


**Figure 4-70. Noise Bandwidth**

---

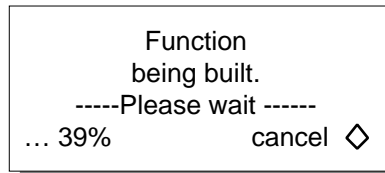
## Analog Noise Output

To generate analog noise, select “analg noise” from the Standard Waveform screen; figure 4-71.



**Figure 4-71. Standard Waveform Screen**

When the Model 395 builds the noise waveform the screen displays a message, see figure 4-72. This message always appears, but may only be seen during longer sequence lengths.



**Figure 4-72. Noise Message**

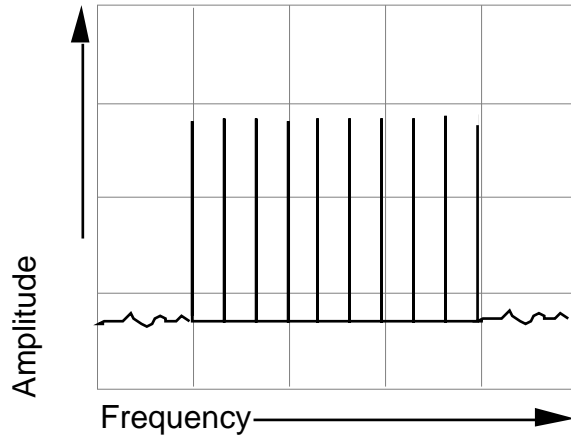
Also, while running noise, set the noise sample clock rate by pressing the FREQUENCY key and program the rate between 100 mHz and 100 MHz. The Frequency screen also displays the actual bandwidth. Varying the sample clock changes the bandwidth start and stop frequencies. While the start and stop frequencies will change with the sample clock, the recommended method of changing them is via the Setup screens.

To vary the amplitude, press the AMPLITUDE key and enter the level in units of V<sub>p-p</sub> or V<sub>p</sub>. Analog noise operates in continuous, triggered, and gated modes, but cannot operate in the sweep mode.

---

#### 4.4.12.15 Comb

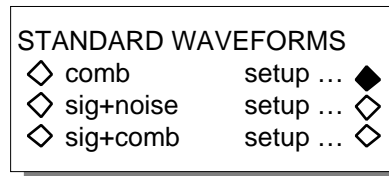
“comb” provides uniformly distributed frequency spectra within a defined frequency band. Figure 4-73 illustrates the comb spectrum. Start and stop range is programmable as well as the comb frequency count.



**Figure 4-73. Comb Spectrum**

#### Comb Setup

To setup comb, select “comb setup” from the Standard Waveform screen (figure 4-74). The first screen, Comb Frequency Band, allows you to set the bandwidth’s start and stop frequencies. The start and stop frequencies appear on the spectrum analyzer as the first and last “teeth” in the spectrum.



**Figure 4-74. Standard Waveforms**

Noise bandwidth screen (figure 4-75) allows the setting of the start and stop frequencies to between 0 Hz and 10 MHz. The comb bandwidth stop frequency must be greater than 111% of the comb bandwidth start frequency, or a 0.9:1 start to stop frequency ratio.

```

COMB FREQUENCY BAND
◆ start: 0.000      Hz
◇ stop: 1.000      MHz
◇ exit              done ◇

```

**Figure 4-75. Comb Frequency Band**

Press F8, “done,” to advance to the Comb Freq Count screen.

Comb Frequency Count (figure 4-75) allows the programming of the number of frequency “teeth” displayed on the spectrum analyzer. The count can be programmed from 3 to 256 “teeth.” The Model 395 equally spaces the frequency teeth between the start and stop frequencies. Figure 4-73 illustrates 10 teeth.

```

COMB FREQUENCY COUNT
◆          100
◇ exit          next ◇

```

**Figure 4-75. Comb Frequency Count**

### Comb Output

To generate a comb spectrum, select “comb” from the Standard Waveform screen; figure 4-76.

```

STANDARD WAVEFORMS
◆ comb          setup ... ◇
◇ sig+noise     setup ... ◇
◇ sig+comb      setup ... ◇

```

**Figure 4-76. Standard Waveform Screen**

When the Model 395 builds the comb spectrum the screen displays a message, see figure 4-77.

```

          Function
          being built.
          -----Please wait -----
... 39%          cancel ◇

```

**Figure 4-77. Message**

Also, while running comb, set the noise sample clock by pressing the FREQUENCY key and program the rate between 100 mHz and 100 MHz. The Frequency screen also displays the actual bandwidth. Varying the sample clock will change the actual bandwidth start and stop frequencies.

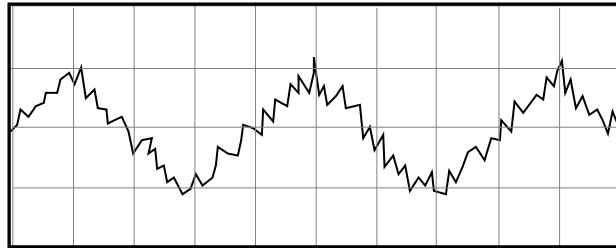
To vary the amplitude, press the AMPLITUDE key and enter the level in units of Vp-p or Vp. Comb operates in continuous, triggered, and gated modes, but cannot operate in the sweep mode.

---

#### 4.4.12.16 Signal Plus Noise

Signal plus noise “sig+noise” (figure 4-78) adds analog noise to any standard or arbitrary waveform with precise signal to noise level control.

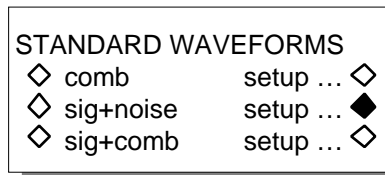
When the signal plus noise waveform is created, the Model 395 uses the noise sequence and bandwidth values to set the sample clock frequency. The Model 395 then expands or compresses the number of points in the signal to generate the waveform frequency at the sample clock frequency.



**Figure 4-78. Signal Plus Noise**

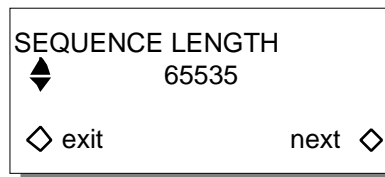
#### Signal Plus Noise Setup

To setup signal plus noise, select “sig+noise setup” from the Standard Waveform screen (figure 4-79).



**Figure 4-79. Standard Waveform**

The screen, Sequence Length (figure 4-80), allows programming of the sequence length using the knob or repeatedly pressing F2. Sequence length accepts 63, 127, 255, 511, 1023, 2047, 4095, 8191, 16383, 32767, and 65535 points.



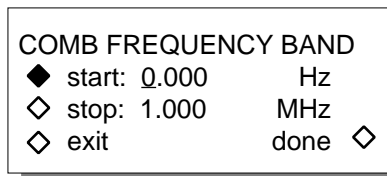
**Figure 4-80. Sequence Length**

After defining the sequence length, press F8, “next” to advance to the Noise Frequency Band Screen. Or, press F4, “exit,” to return to the Standard Waveform.

---

### Noise Frequency Bandwidth

Noise frequency bandwidth screen (figure 4-81) sets the start and stop frequencies (0 Hz to 10 MHz). The comb bandwidth stop frequency must be greater than 111% of the comb bandwidth start frequency, or a 0.9:1 start to stop frequency ratio.

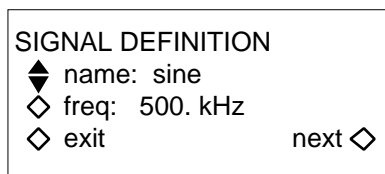


**Figure 4-81. Noise Frequency Band**

Press F8 “next,” to advance to Signal Definition. Or, press F4, “exit,” to return to the Standard Waveform.

### Signal Definition

Signal Definition (figure 4-82) selects the waveform (signal) and programs the waveform frequency.



**Figure 4-82. Signal Definition**

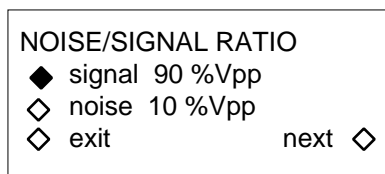
Select the waveform (standard or arbitrary) by pressing F2, rotating the knob, or pressing the cursor keys. Sin(x)/x, Pulse, Pulse Train, and all noise waveforms cannot be used as waveforms.

Program the waveform frequency by pressing F3. Then use the knob or keypad to program the frequency between 10 mHz and 10 MHz.

Press F8 “next” to advance to Signal/Noise Ratio screen. Or, press F4, “exit,” to return to the Standard Waveform.

### Signal Plus Noise Ratio

Signal plus noise ratio (figure 4-83) allows you to set the ratio of the signal to noise as percentage of volts peak to peak. Either the noise or signal percentage can be set, but changing one will affect the other. The sum of the signal and noise percentage adds up to 100%.



**Figure 4-83. Noise/Signal Ratio**

Press F2, “signal,” to change the peak to peak value (programmable between 1% and 99%) of the signal using the knob or keypad. Increasing the value decreases the noise value and vice versa.

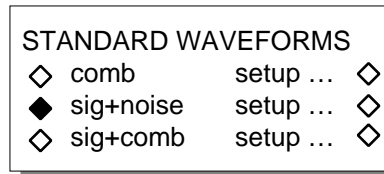
---

Press F3, “noise,” to change the peak to peak value (programmable between 1% and 99%) of the noise using the knob or keypad. Increasing the value decreases the signal value and via versa.

Press F4, “exit,” to return to the Standard Waveform screen, or press F8, “next,” to step to the Sequence Length screen.

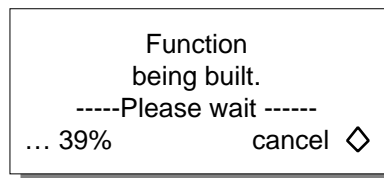
### Signal Plus Noise Output

To generate signal plus noise, select “sig+noise” from the Standard Waveform screen; figure 4-84.



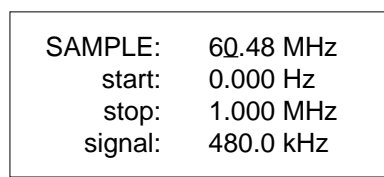
**Figure 4-84. Standard Waveform Screen**

When the Model 395 builds the signal plus noise waveform, the screen displays a message, see figure 4-85.



**Figure 4-85. Message**

Also, while running signal plus noise, set the noise sample clock by pressing the FREQUENCY key, and program the sample rate between 100 mHz and 100 MHz. The Frequency screen (figure 4-86) also displays the noise bandwidth start and stop frequencies and the signal frequency. Varying the sample clock will change the actual bandwidth start and stop frequencies.



**Figure 4-86. Frequency - Sig+Noise Screen**

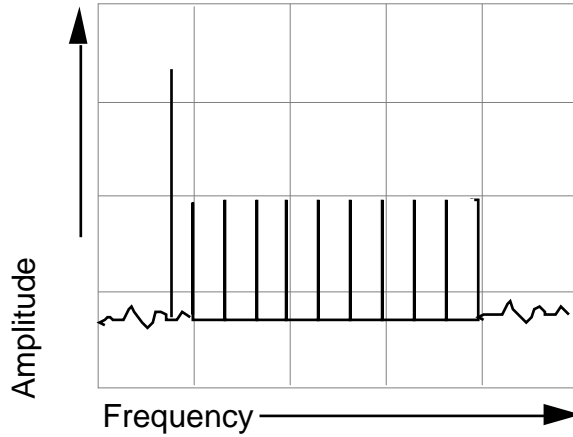
To vary the amplitude, press the AMPLITUDE key and enter the level in units of  $V_p$ -p or  $V_p$ .

Signal plus noise operates in continuous, triggered, and gated modes, but cannot operate in the sweep mode.

---

#### 4.4.12.17 Signal Plus Comb

Signal plus comb “sig+comb” (figure 4-87) allows any standard or arbitrary waveform to be added to comb waveform with precise control of the signal to comb level.



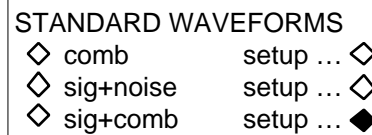
---

**Figure 4-87. Signal Plus Comb**

**(75% Signal Vp-p) Spectrum Analyzer**

#### Signal Plus Comb Setup

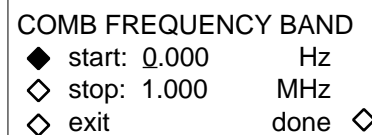
To setup signal plus comb, select “sig+comb setup” from the Standard Waveform screen (figure 4-88).



---

**Figure 4-88. Standard Waveform**

The first screen, Comb Frequency Band, (figure 4-89) sets the start and stop frequencies (0 Hz to 10 MHz). The comb bandwidth stop frequency must be greater than 111% of the comb bandwidth start frequency, or a 0.9:1 start to stop frequency ratio.



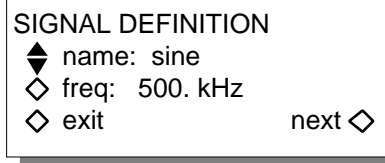
---

**Figure 4-89. Comb Frequency Band**

Press F8, “done,” to advance to the Signal Definition screen, or press F4, “exit,” to return to the Standard Waveform screen.

Signal Definition (figure 4-90) selects the waveform (signal) and programs the waveform frequency.





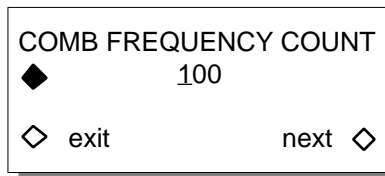
**Figure 4-90. Signal Definition**

Select the waveform (standard and arbitrary) by pressing F2, rotating the knob, or pressing the cursor keys. Pulse, Pulse Train, and all noise waveforms cannot be used as waveforms.

Program the waveform frequency by pressing F3. Then use the knob or keypad to program the frequency (10 mHz to 10 MHz).

Pressing F8 “next” advances to Comb Freq Count screen. Or, press F4, “exit,” and return to the Standard Waveform.

Comb Frequency Count (figure 4-91) programs the number of frequency “teeth” displayed by the spectrum analyzer. The Count is programmable between 3 and 256 “teeth.” The Model 395 spaces the frequency teeth equally between the start and stop frequencies. Figure 4-73 illustrates 10 teeth.

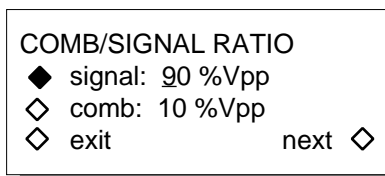


**Figure 4-91. Comb Frequency Count**

Press F8, “done,” to advance to the Comb/Signal Ratio screen. Or, pressing F4, “exit,” returns to the Standard Waveform.

### Comb / Signal Ratio

Comb / Signal ratio (figure 4-92) sets the ratio of the signal to comb as percentage of volts peak to peak. Either the comb or signal percentage can be set, but changing one will affect the other. The sum of the comb and noise percentage will be 100%.



**Figure 4-92. Comb/Signal Ratio**

Pressing F2, “signal,” and then using the knob or keypad changes the peak to peak value (1% to 99%) of the signal. Increasing the value will decrease the noise value and vice-versa.

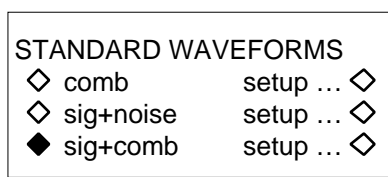
Press F3, “comb,” to change the peak to peak value (programmable between 1% and 99%) of the comb using the knob or keypad. Increasing the value will decrease the signal value and vice-versa.

Press F4, “exit,” to return to the Standard Waveform screen, or press F8, “next,” to wrap around to the Comb Frequency Band screen.

---

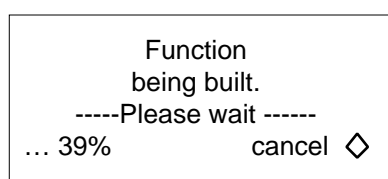
## Signal Plus Comb Output

To generate signal plus comb, select “sig+comb” from the Standard Waveform screen; figure 4-93.



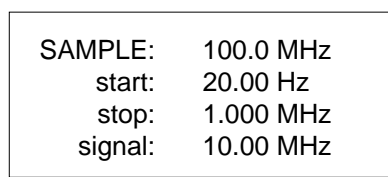
**Figure 4-93. Standard Waveforms**

When the Model 395 builds the signal plus comb waveform, the screen displays a message, see figure 4-94.



**Figure 4-94. Message**

Also, while running signal plus comb, set the noise sample clock by pressing the FREQUENCY key and program the sample rate between 100 mHz and 100 MHz. The Frequency screen (figure 4-95) also displays the frequency bandwidth start and stop frequencies, and the signal frequency. Varying the sample clock will change the actual bandwidth start and stop frequencies.



**Figure 4-95. Frequency - Sig+Comb Screen**

To vary the amplitude, press the AMPLITUDE key and enter the level in units of Vp-p or Vp.

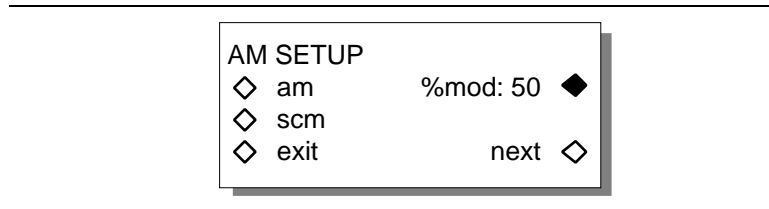
Signal plus comb operates in continuous, triggered, and gated modes, but cannot operate in the sweep mode.

---

#### 4.4.12.18 AM / SCM

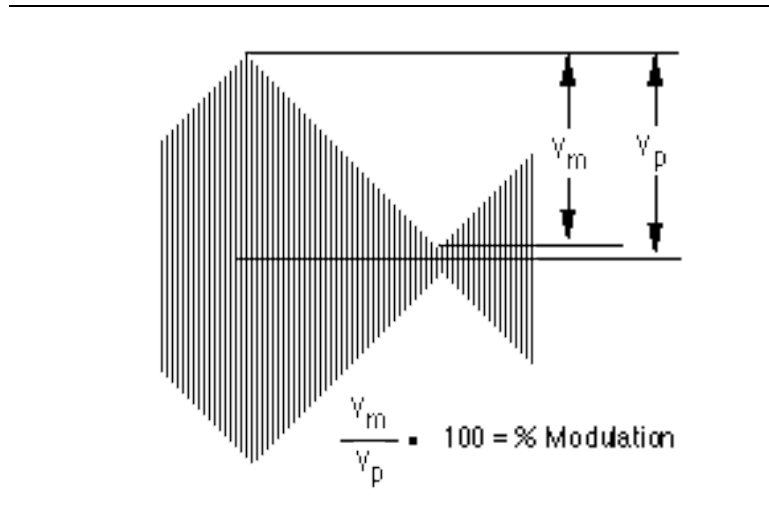
Selecting AM allows you to select internally modulated amplitude modulation or suppressed carrier modulation. From the AM Setup screen you can independently set the carrier frequency and the modulation frequency, as well as set the modulation waveform. The carrier waveform will always be a sine wave. From the Standard Waveform screen, select “am” to build the AM waveform. Or, select “am setup ...” to setup the waveform.

Selecting “am setup...” to display the AM SETUP screen; see figure 4-95a.



**Figure 4-95a. AM Setup Screen**

Press F2, “am,” to select Amplitude Modulation. Then press F5 and use the knob or keypad to enter the percent modulation. Modulation percentage is defined as:

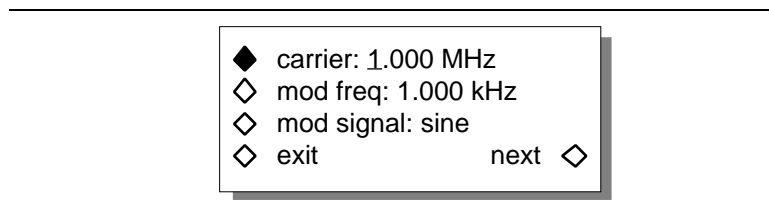


where  $V_m$  = modulation voltage, and  $V_p$  = modulated carrier voltage  
In AM, the percent of modulation can be varied between 0% and 200%; 200% modulation in AM is the same as SCM.

Pressing F3 selects SCM which automatically sets the modulation percentage to 200%. But the screen will not display 200%.

Press F4, “exit,” to return to the Standard Waveform screen. If “am” was selected before setup, the Model 395 will construct the AM waveform.

Press F8, “next,” to setup the modulation and carrier frequencies and select the modulating signal. See figure 4-95b.



**Figure 4-95b. Modulation Screen**

---

Press F1, “carrier,” and use the knob or keypad to program the frequency of the carrier. Carrier frequency can be programmed between 0.01 Hz and 40 MHz. The carrier will always be a sine wave.

Press F2, “mod freq,” and use the knob or keypad to enter the frequency of the modulating signal. Modulation frequency can be programmed between 0.01 Hz and 40 MHz.

**NOTE**

When the carrier frequency to modulation frequency ratio exceeds:

65535/2.5 or 26,214:1

the Model 395 gives an error message.

Press F3, “mod signal,” and use the knob or keypad to step through the listing of modulation waveforms. The list includes all waveforms except pulse, pulse-train, signal plus noise, signal plus comb, comb, analog and digital noise. Note: these waveforms can be copied into an Arb waveform using “create from copy.”

Press F8, “next,” to return to the AM Setup screen. Or, press F4, “exit,” to return to the Standard Waveform screen.

To generate the AM or SCM waveform, select “am” from the Standard Waveform screen.

Frequency Key - pressing the Frequency key while the AM waveform is running displays:

---

AM FREQUENCY sample: 32.87 MHz (carrier: 1.003 MHz) (mod freq: 1.003 kHz)
--

---

This screen displays the sample clock used to construct the AM waveform. The screen also displays the carrier and modulation frequencies. By changing the sample frequency you can alter the carrier and modulation frequencies.

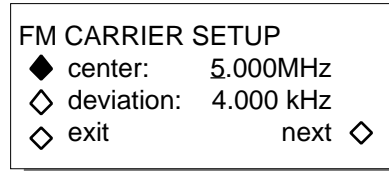
The Model 395 creates the AM and SCM waveforms by generating an integer multiple of cycles (i.e. both the carrier and modulation waveforms end at the zero crossing point). In order for the Model 395 to generate these integer multiples, it sometimes becomes necessary to alter one of the frequencies - the software algorithm in the Model 395 chooses to alter the carrier frequency. Thus, the carrier frequency may be slightly off from the programmed carrier frequency. Therefore, change the sample frequency and note the change in the carrier and modulation frequencies. This is a trial and error method of changing the carrier frequency.

---

#### 4.4.12.19 FM

Selecting FM allows you to select internal frequency modulation. From the FM screen you can set the independent center and the modulation frequencies, as well as set the deviation range. The modulating signal can be selected, but the carrier waveform will always be a sine wave. From the Standard Waveform screen, select “fm” to generate the FM waveform. Or, select “fm setup ...” to setup the waveform.

Selecting “fm setup...” to display the FM CARRIER SETUP screen; see figure 4-95c.



**Figure 4-95c. FM Carrier Setup Screen**

Press F2, “center:,” to change the FM center frequency. Then use the knob or keypad to enter the center frequency value. Center frequency is programmable between 0.01 Hz and 40 MHz.

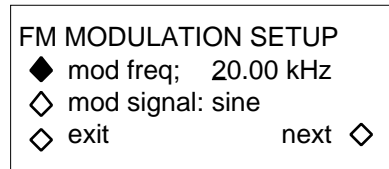
Pressing F3, “deviation,” allows you to program the peak frequency deviation from the carrier. Deviation value programmed represents the peak frequency generated for a full peak “amplitude.” The Model 395 does not take into account the modulating signal when the screen displays the deviation. Thus, a sine wave modulating signal will swing the frequency the full + and - deviation about the center frequency. But a waveform like the haversine will only vary the frequency from the center to + or - depending on the polarity of the haversine. Deviations for Arb waveforms depend upon the data values programmed (+0000; +2047, -2048) when the waveform was created.

**Note**

The Model 395 does not allow the positive deviation to extend beyond the maximum frequency (40 MHz). For example, a center of 30 MHz and deviation of 10 MHz will produce an error.

Select F8 “next” to advance to the FM Modulation Setup screen, or press F4 “exit” to return to the Standard Waveform screen.

The FM Modulation screen (figure 4-95d) sets up the modulation frequency and waveform. To program the modulating frequency, press F2 “mod freq” and use the knob or keypad to enter the value. The modulation frequency can be programmed between 0.01 Hz and 40 MHz. But the Model 395 does limit frequencies based on the internal FM algorithm.



**Figure 4-95d. FM Modulation Setup Screen**

---

Press F3, “mod signal,” and use the knob or keypad to step through the listing of modulation waveforms. The list includes all waveforms except pulse, pulse-train, signal plus noise, signal plus comb, comb, analog and digital noise. Note: these waveforms can be copied into an Arb waveform using “create from copy.”

Press F8, “next,” to return to the FM Carrier Setup screen. Or, press F4, “exit,” to return to the Standard Waveform screen.

To generate the FM waveform, select “fm” from the Standard Waveform screen.

Frequency Key - pressing the Frequency key while the FM waveform is running displays:

---

FM sample: 100.0 MHz (center: 5.000 MHz) (mod freq: 20.00 kHz) (deviate: 4.000 kHz)
--

---

The Model 395 creates the FM waveform by generating an integer multiple of cycles (i.e. both the center and modulation waveforms end at the zero crossing point). In order for the Model 395 to generate these integer multiples, it sometimes becomes necessary to alter one of the frequencies - the software algorithm in the Model 395 chooses to alter the center frequency. Thus, the center frequency may be slightly off from the programmed center frequency. Therefore, change the sample frequency and note the change in the center and modulation frequencies. This is a trial and error method of changing the center frequency.

#### 4.4.12.20 Arb Waveforms

From the Standard Waveform screen (figure 4-96), select “arb” to display a list of all defined arbitrary waveforms (figure 4-97). To create Arb waveforms, refer to paragraph 4.4.3 Arbitrary Waveforms.

---

STANDARD WAVEFORMS	
◇ fm	setup ... ◇
◆ arb	
◇ sequence	

---

Figure 4-96. Standard Waveform Screen

---

ARBITRARY WAVEFORMS	
◇ sv1	001024
◇ zx1	02691
◇ wv2	00250

---

Figure 4-97. Arb Waveform Screen

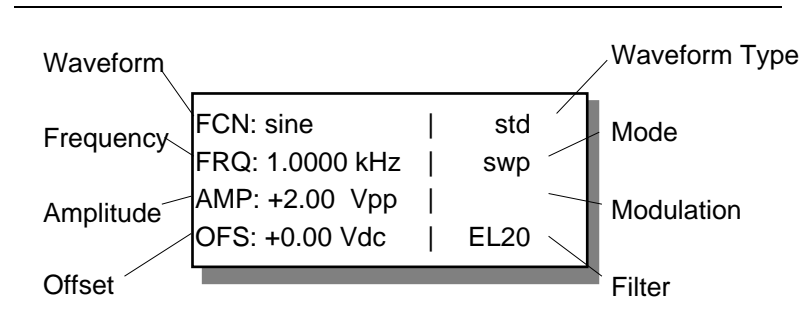
#### 4.4.12.21 Sequence

From the Standard Waveform screen, select “sequence” to start the sequence setup using the Sequence key; also see paragraph 4.4.10.

---

## 4.4.13 STATUS

The Status key allows you to quickly view the currently programmed parameters of the Model 395. Figure 4-99 illustrates a typical status screen. The Model 395 only displays this screen when the STATUS key is pressed.



**Figure 4-99. Status Screen**

Waveform (FCN)	lists the name of the current waveform. If running a sequence, a waveform (FCN) name will not be displayed.
Waveform Type	identifies the current waveform as standard (std), arbitrary (arb), or sequence (seq).
Frequency (FRQ)	displays the current frequency or period of the waveform. A "W" preceding the measurement units indicates waveform frequency.
Mode	displays the current operating mode.
Amplitude (AMP)	displays the current amplitude value and measurement units.
Modulation	indicates the current modulation mode. Blank signifies AM IN is off.
Offset (OFS)	displays the currently programmed offset value.
Filter	lists the current output filter.

---

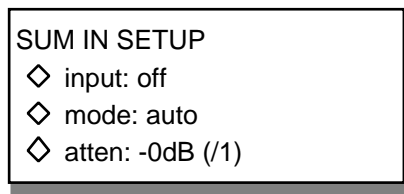
#### 4.4.14 SUM IN

Sum produces an output proportional to the instantaneous amplitude of the internally generated signal and the instantaneous amplitude of the external Sum In signal. The Model 395 sums (adds) the signals before its output attenuators which affects the attenuation of the input signal. The output attenuation is initially set by the programmed Amplitude and Offset, but through the Sum In screen the attenuators can be changed.

If the automatic mode is selected, the attenuator selected on the Sum In screen will change if the peak amplitude plus offset is outside the limits listed under “Attenuator.”

Manual mode locks in the attenuator regardless of a change in amplitude or offset. In this mode, the peak amplitude plus offset cannot exceed the maximum level for the selected attenuator’s range (see the limits listed under “Attenuator.” However, the range’s lower limit can be exceed, but possibly with some loss of resolution.

To sum an external signal with the internal signal, setup the Model 395 as described in this section. Then, press the SUM IN key to display the Sum In screen; see figure 4-100.



**Figure 4-100. Sum In Screen**

#### **Input**

“input” enables (on) and disables (off) the front panel’s Sum In connector. To change the state, press the F2 until the desired state appears. Also, the knob or cursor can be used, when “input” is highlighted, to change the state.

#### **Mode**

Use “mode” to step between the attenuator’s “auto” state and the “manual” state. When automatic is selected, the attenuator can be temporarily changed. But, changing the amplitude or offset sets the attenuator to match the level change.

Manual locks the selected attenuation regardless of a change in the amplitude or offset.

To switch between “automatic” and “manual” attenuator, press F3. When “mode” is highlighted, the knob and cursor can be used.

#### **Attenuator**

Use “atten” to select one of the Model 395’s binary output attenuators. Each time the key F4 is pressed, the screen steps to the next attenuator. When the “atten” is highlighted, the knob or cursor can also be used to change the attenuator setting. Remember, in the auto mode, changing the amplitude or offset could affect the attenuator. The following table lists the output level range relative to selectable attenuators:

<b>Attn (Division)</b>	<b>Peak Ampl + Offset</b>
-0 dB (/1)	2.500 to 5.00Vp
-6 dB (/2)	1.250 to 2.500Vp
-12 dB (/4)	0.625 to 1.250Vp
-18 dB (/8)	0.313 to 0.625Vp
-24 dB (/16)	0.156 to 0.313Vp
-30 dB (/32)	0.078 to 0.156Vp
-36 dB (/64)	0.039 to 0.078Vp
-42 dB (/128)	0.019 to 0.039Vp



---

#### 4.4.15 SWEEP

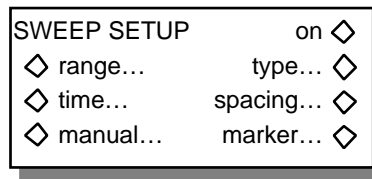
As a sweep generator, the Model 395 produces an output waveform with frequencies that sweep between the programmed start and stop frequencies. The Model 395 sweeps both standard and arbitrary waveforms over a 1mHz to 20.0 MHz range with programmable sweep time from 30 ms to 1000s. Sweep mode provides two sweep spacings (linear and logarithmic), two sweep directions (up and down) and seven sweep types:

Continuous 1 direction	(continuous sweep and reset),
Continuous 2 directions	(continuous sweep and return),
Triggered 1 direction	(triggered sweep and reset),
Triggered 2 directions	(triggered sweep and return),
Triggered, hold and Reset	(triggered sweep and hold with triggered reset),
Triggered, hold 2 directions	(triggered sweep and hold with triggered return),
Manual.	

During sweep, the Model 395 inserts a 20 MHz Elliptical filter at the output. Sweeping arbitrary waveforms with spectral content beyond 20 MHz will distort the waveform. At higher frequencies, position markers and sync markers may not function normally due to the Direct Digital Synthesis (DDS) technique. “Frequency” actually depends on the original waveform size (50 MHz/waveform size).

The Model 395 uses a 2048 sweep table. Thus, regardless of the sweep range, the Model 395 divides the start and stop “frequency” into 2048 frequency steps. At sweep times of 1.02 seconds and greater, sweep will step through all 2048 frequency steps. Below 1.02 seconds, frequency sweep contains fewer steps due to the 0.5 ms interrupt at each step. At a 30 ms sweep time, the frequency sweep contains only 60 steps. To sweep arbitrary waveforms, the Model 395 expands or condenses the waveform to fit into exactly 4096 points. This does not affect the original data. Also, the internal sample rate is set to 50 MHz. Arbitrary waveform sweep uses DDS techniques.

Press the SWEEP OUT key to display the Sweep Setup screen; figure 4-101. Use this screen to select sweep mode, waveform, range, and time (sweep rate). Plus, use the screen to activate manual sweep (knob), as well as, define markers.



**Figure 4-101. Sweep Out Screen**

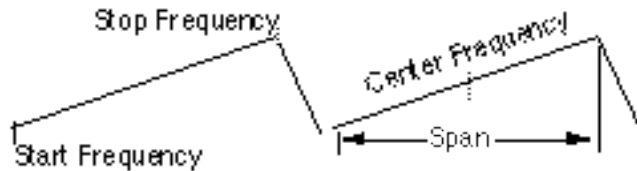
#### On

Selecting “on” (press F5) enables the sweep mode. This is same as selecting “sweep” on the Mode screen.

---

## Range

This screen displays the sweep range, which can be defined by as start and stop frequencies, or center and span frequencies. *Start/stop* allows you to define the two end points of the sweep. *Center/span* allows you to set the center frequency and the frequency span around the center frequency.



### Start/Stop

Press F2 “start” to set the sweep start frequency. Press F3 “stop” to set the stop frequency. See figure 4-102. Use the keypad or knob to set the frequencies. Frequency range is 1mHz to 20 MHz.

---

SWEEP RANGE	
◇ start: 1.000	kHz
◇ stop: 10.00	kHz
◇ center/span	done ◇

---

Figure 4-102. Sweep Range

### Center /Span

To select *center/span*, press F4. Press F2 “center” to set the center frequency. Press F3 “span” to set the frequency span. Use the keypad or knob to set the frequencies. See figure 4-103.

---

SWEEP RANGE	
◇ centr: 5.500	kHz
◇ span: 9.000	kHz
◇ start/stop	done ◇

---

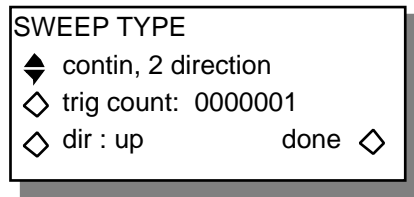
Figure 4-103. Sweep Range (Center Span)

## Type

Sweep type defines the sweep mode of the Model 395. From this screen (figure 4-104) set up the sweep type, sweep trigger count, and sweep direction.

Select the sweep type by pressing F2 and using the knob, cursor keys, or F2 key to scroll through the list. Enter a trigger count by pressing F3 and entering the value between 1 and 1,000,000 (1 exp 6) using the knob or keypad.

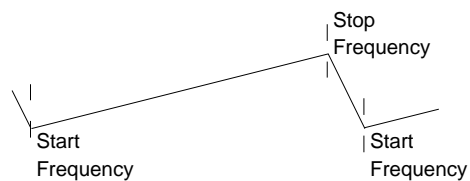
Select the sweep direction by pressing F4 and using the knob, cursor, or F4 key to toggle between up and down. Sweep up causes the sweep to sweep between the start frequency and the stop frequency. Sweep down sweeps between the stop frequency and the start frequency.



**Figure 4-104. Sweep Type**

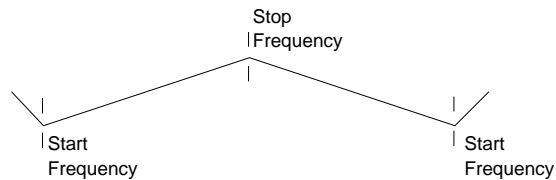
### Continuous, 1 Direction

Continuous 1 direction sweeps continuously between the start and stop frequencies at a rate set by sweep time. At the stop frequency, the generator resets to the start frequency before continuing the sweep. Select this sweep type by choosing “contin, 1 direction.”



### Continuous, 2 Direction

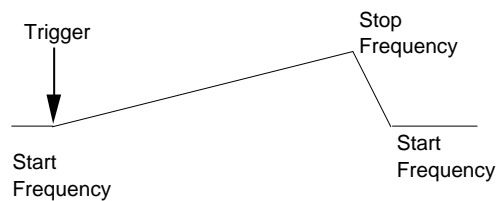
Continuous 2 direction sweeps continuously from the start frequency to the stop frequency and sweeps back to the start frequency. Pick this sweep type by selecting “cont, 2 direction.”



### Triggered, 1 Direction

Triggered, 1 directions holds the output frequency at the start frequency until the unit receives a trigger. When triggered, the frequency sweeps to the stop frequency and resets to the start frequency. The frequency remains at the start frequency until another trigger is received. Choose this sweep type by selecting “trig, 1 direction.”

Select “trig count” (F3) to define the number of sweep cycles repeated when the waveform is triggered. Use the TRIG IN key to setup the trigger conditions; see paragraph 4.4.17 Trigger.

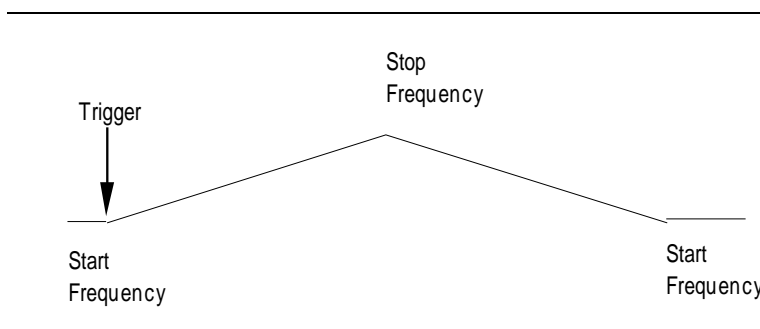


---

## Triggered, 2 Direction

Triggered, 2 direction holds the output at the start frequency until the unit receives a trigger. When triggered, the frequency sweeps to the stop frequency and sweeps back to the start frequency. The frequency remains at the start frequency until another trigger is received. Choose this sweep type by selecting “trig, 2 direction.”

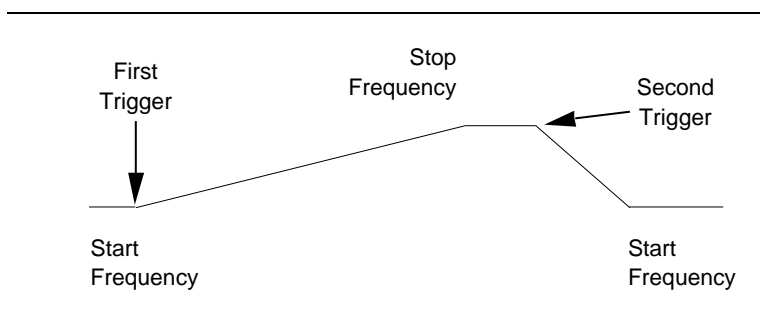
Selecting “trig count” (F3) defines the number of cycles repeated in the triggered waveform. Use the TRIG IN key to setup the trigger conditions; see paragraph 4.4.17 Trigger.



## Trigger, Hold, Reset

Trigger, hold, reset holds the output at the start frequency until the unit receives a trigger. When triggered, the frequency sweeps to the stop frequency and holds at the stop frequency. A second trigger resets the output to the start frequency. The output remains at the start frequency until another trigger is received. Choose this sweep type by selecting “trig, hold, reset.”

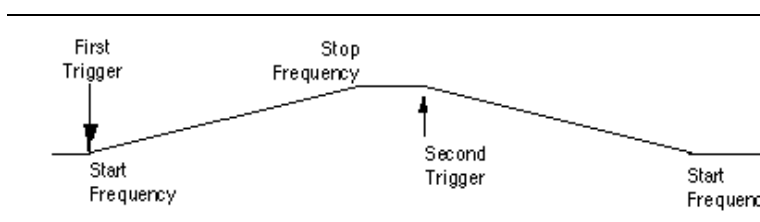
Use the TRIG IN key to setup the trigger conditions; see paragraph 4.4.17 Trigger.



## Trigger, Hold 2 Direction

Trigger, hold, 2 direction holds the output at the start frequency until receipt of a trigger. Upon receiving the trigger, the frequency sweeps to the stop frequency and holds at the stop frequency. A second trigger initiates a sweep from the stop frequency back to the start frequency. The output remains at the start frequency until another trigger is received. Select this sweep type by choosing “trig, hold 2 dir.”

Use the TRIG IN key to setup the trigger conditions; see Trigger.

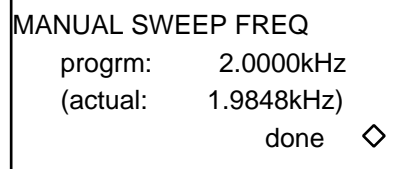


---

## Manual

“manual” sweep allows you to use the knob to change frequency. In manual sweep, sweep parameters remains set to the start and stop frequencies, the sweep function, and the sweep time. Because the Model 395 uses a 2048 step sweep table, the programmed frequency may not be the actual frequency generated by the unit. The Manual Sweep Frequency screen displays both programmed and actual frequencies. See figure 4-105.

---



```
MANUAL SWEEP FREQ
  prog:    2.0000kHz
(actual:   1.9848kHz)
                        done ◇
```

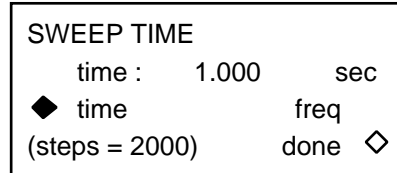
---

**Figure 4-105. Manual Sweep Screen**

## Time

Sweep time, figure 4-106, is the time it takes to produce one sweep transition between start and stop frequencies, and back to the start frequency or the time of the sweep DAC (Sweep Out) ramp. Program the sweep time in seconds between 30 ms to 1000s with 1 ms resolution using the keypad or knob. Sweep time can also be programmed in frequency between 1mHz to 33.333 Hz. Press F3, “time,” to display the units in time, or press F7, “freq,” to display the units as a frequency. Press F8 when finished.

---



```
SWEEP TIME
  time :    1.000    sec
◆ time          freq
(steps = 2000)  done ◇
```

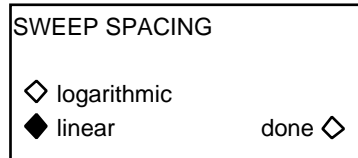
---

**Figure 4-106. Sweep Time**

## Spacing

Spacing selects either linear or logarithmic sweep spacing. See figure 4-107. Linear (press F4) sweep changes the frequency at a linear rate, and logarithmic (press F3) sweep causes the frequency to spend equal time in each octave or decade. Regardless of the sweep spacing, the Sweep Out always supplies a linear ramp.

---



```
SWEEP SPACING
◇ logarithmic
◆ linear          done ◇
```

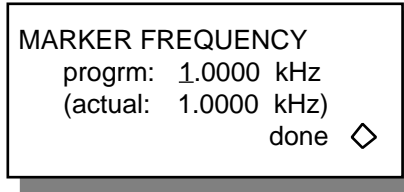
---

**Figure 4-107. Spacing Screen**

---

## Marker

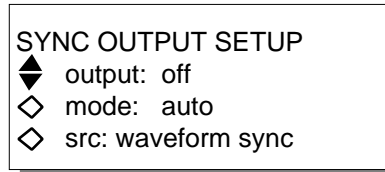
Sweep marker allows selection of frequency which produces a sweep marker pulse. When “marker” is selected, see figure 4-108, use the knob or keypad to set the marker frequency. If the marker frequency is programmed outside the programmed sweep range, the Model 395 places the marker frequency within the sweep range. Enable the marker from the SYNC OUT key - “src: swp marker.”



**Figure 4-108. Sweep Marker Screen**

## 4.4.16 SYNC OUT

The Model 395 provides seven sources, or types, of sync pulses for synchronizing external devices with the Model 395. To access the Sync Out screen (see figure 4-109), press the SYNC OUT key. From this screen enable and specify the synchronizing source.



**Figure 4-109. Sync Out Screen**

## Output

Enable the Sync Out connector by pressing “output” (F2) until “on” appears, or disable the connector by pressing “output” (F2) until “off” appears. When “output” is highlighted, the knob or cursor can be used to switch between on and off. A lit indicator next to the Sync Out connector identifies “output: on.”

## Mode

Automatic lets the Model 395 select the best sync source based on the Model 395’s operating conditions. When automatic is selected, the source can be temporarily changed. But, changing the operating conditions could change the sync back to the “best” source.

Manual allows changing the source and retaining the selected source regardless of the operating conditions.

To switch between “automatic” and “manual” sync mode, press F3, and use the F3 key, knob, or cursor to toggle between “automatic” and “manual.”

---

## Source (src)

Select the Sync Source by pressing the “src:” (F4) to cycle through the list. Also, use the knob or cursor keys to cycle through the same list.

### Waveform Sync

The Model 395 generates a sync marker pulse coincident with the Main Output waveform. For standard waveforms, the sync marker is coincident with the zero-crossing point of the waveform. For arbitrary waveforms, the sync marker is coincident with the first few points (addresses) of the Arb waveform. In a sequence, each waveform in the sequence generates its own sync marker.

### Pos'n Marker

When position (pos'n) marker is selected, the Model 395 generates a pulse marker pattern for arbitrary waveforms. The pulse pattern is programmable from the *Waveform Edit* screen, and an Arb waveform can have multiple position markers.

### Burst Done

Burst Done produces a sync marker pulse coincident with the start of the last cycle of Trigger count; see Mode

### Loop Done

Loop Done generates a sync marker pulse at the completion at the end of each loop count in a sequence.

### Trigger

Trigger produces a sync marker which is generated by the trigger source: internal or external. Use the trigger sync source for any trigger or gated operation (mode, trigger advance, etc.). Manual trigger and bus triggers also produce a trigger sync marker.

### Sweep Marker

Sweep Marker produces a sync marker at the frequency programmed via “marker...” from the Sweep Setup screen (SWEEP OUT key).

### Pen Lift

When sweep is active, pen lift provides a sync marker to be used by plotters. Use this output to place the pin of the plotter down while the unit sweeps, and up during sweep retrace.

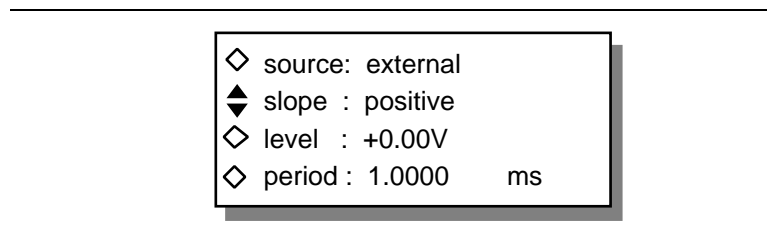
---

## 4.4.17 TRIGGER

Many Model 395 operations require the setup of trigger parameters. The Model 395 provides a Trigger Input screen which allows you to select internal source (programmable rate), external source (Trig In connector) with programmable trigger slope and polarity, or manual source (MAN TRIG key). Model 395 operations are affected by the trigger input conditions are sequence advance trigger, triggered sweep, and triggered and gated modes.

In the gated mode, the Model 395 produces a continuous output with external trigger selected and slope set to negative as long as the quiescent external trigger input is below the trigger level.

To set up the trigger input, press the TRIG IN key to display the Trigger Input screen (figure 4-110).



**Figure 4-110. Trigger Setup Screen**

### Source

Press F1 to toggle between internal, external, and manual trigger sources. When “internal” is selected, the Model 395 uses its internal trigger generator as the trigger source. Trigger rate is programmed using “period.” Slope and level have no effect on internal trigger. However, when internally triggered, the waveform can be triggered by pressing MAN TRIG key or sending remote trigger commands (\*TRG etc. - refer to section 5).

When “external” is selected, a signal at the Trig In connector triggers the generator. The trigger slope and level parameters affect the trigger conditions for the external signal. When externally triggered, the waveform can also be triggered by pressing MAN TRIG key or sending remote trigger commands (\*TRG etc. - refer to section 5).

When “manual” is selected, pressing the MAN TRIG key or sending remote trigger commands (\*TRG etc. - refer to section 5) triggers the waveform.

### Slope

Press F2 to toggle between positive trigger slope and negative trigger slope. Slope sets the triggering edge of the external trigger signal.

### Level

Press F3 to program the trigger level. Use the keypad or the knob to change the value. The trigger level can be programmed between -10.0 V and +10.0 V with 0.1 V resolution.

### Period

Press F4 to program the trigger rate of the internal trigger generator. Use the keypad or knob to change the value. Trigger rate can be programmed between 200 ns and 10000 seconds.



---

## 4.4.18 UTILITY

Press the UTILITIES key to display the Utilities screen (see figure 4-111). Use this screen to define the power on settings, to view system information, to calibrate the instrument, and to transfer a waveform captured with a Digital Storage Oscilloscope (DSO) directly into the Model 395 via GPIB cable (option 001 required).

---

◇ power-on setting ...  
◇ system info ...  
◇ calibration ...  
◇ DSO upload ...

---

**Figure 4-111. Utilities Screen**

### Power On Setting

Pressing the “power-on setting ...” (F1) from the UTILITY menu selects how the Model 395 powers on (see figure 4-112).

---

POWER ON SETTING  
◇ use default values  
◇ restore last setup  
◇ recall "startup"

---

**Figure 4-112. Power-On Setting Screen**

### Default Values

Press F2 “use default values” to use the Model 395’s internal default values as power on conditions. The Model 395 will power on the following conditions.

Frequency	1.000000000 kHz	
Amplitude	+1.00 Vp	
Offset	+0.00 Vdc	
Mode	Continuous	
Trig Count	1	
Filter	Auto, 20 MHz Elliptic	
Waveform	Standard, Sine	
Sweep	Off	
	Range	Start: 1.000 kHz Stop: 10.00 kHz
	Direction	Up
	Time	1.000 Sec
	Type	Continuous Sweep, 1 direction
	Trig Count	1
	Spacing	Linear
	Marker Freq	1.000 kHz
Trig In	Source	Internal
	Period	5.0000 ms
	Slope	Positive
	Level	+0.00 V
Sync	Off	
	Automatic	
	Source	Waveform Sync
AM In	Off	
Sum In	Off	
Main Out	Off	

---

### Restore Last Setup

Press F3, “restore last setup,” allows the Model 395 to power up to the instrument conditions at powered off.

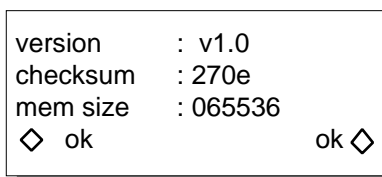
### Recall Startup

Press F4, ‘recall “startup”,’ to use a stored setting named “startup” for power on conditions. Create the stored setting “startup” from the SETUP screens; paragraph 4.4.11.

## System Information

Selecting “system info...” lists the instrument’s firmware version, checksum value, and memory size in bytes. See figure 4-113.

---



```
version      : v1.0
checksum     : 270e
mem size    : 065536
◇ ok                               ok ◇
```

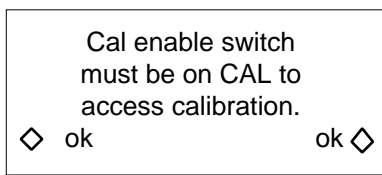
---

**Figure 4-113. System Information**

## Calibration

The Model 395 contains an internal calibration procedure which requires a minimum of test equipment. Under normal operating conditions the screen displays an calibration information screen; see figure 4-114. The Cal Enable switch, which is located on the rear panel (paragraph 4.3), is usually set to the “NORM” state and covered with a Calibration sticker to prevent accidental changing of the switch. The calibration procedure is covered in the Calibration supplement to this manual.

---



```
Cal enable switch
must be on CAL to
access calibration.
◇ ok                               ok ◇
```

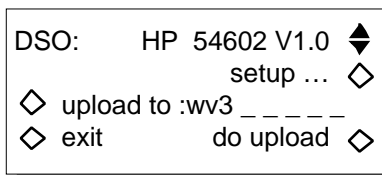
---

**Figure 4-114. Calibration Screen**

## DSO Upload

DSO Upload allows you to transfer arb waveforms captured on a digital storage oscilloscope directly to the Model 395. For DSO Upload, option 001, GPIB Interface/ Direct DSO Waveform Transfer) must be installed in the Model 395. Selecting “DSO upload” displays the DSO screen (figure 4-115) which appendix F describes in detail.

---



```
DSO:   HP 54602 V1.0 ◆
        setup ... ◇
◇ upload to :wv3 _ _ _ _ _
◇ exit      do upload ◇
```

---

**Figure 4-115. DSO Upload Screen**

---

#### 4.4.19 REF IN / REF OUT

##### Ref In

Use the Ref In connector to accept a 10 MHz external reference. The Model 395 detects the external reference signal and automatically switches from the internal reference to the external reference. The reference must be  $10 \pm 0.5$  MHz, 1 V<sub>p-p</sub> to 10 V<sub>p-p</sub> (50 V<sub>dc</sub> max.) 40% to 60% duty-cycle square wave or bipolar sine wave signals. Input impedance is >1k (ac coupled). There are no front panel screens or remote commands to control the reference input.

##### Ref Out

The reference output supplies a buffered 10 MHz TTL internal system clock output. Also, this connector can supply a buffered reference output with an external 10 MHz clock connected to REF IN. Output signal level is approximately 1.5 V<sub>p-p</sub> into 50 .



## 5.1 INTRODUCTION

Model 395 firmware supports several industry standards and specifications (SCPI, IEEE 488.2, RS-232, and IEEE 488.1) in remote operation.

The SCPI Standard, first published in 1990, is layered on top of the IEEE 488.2 Standard. SCPI defines program messages, response messages, and data formats that are consistent across all instruments, regardless of manufacturer. The goal of these definitions is to reduce ATE program development time. SCPI is designed to be layered on top of the interface independent portion of IEEE 488.2. It is independent of the controller to instrument interface.

In the simplest sense, the IEEE 488.2 standard defines the syntax of a command language while the SCPI standard defines the vocabulary.

This standard defines communication protocols necessary to effect application independent device-dependent message exchanges and defines common commands and characteristics useful in instrument system applications.

Among the items this standard defines are standard message handling protocols including error handling, unambiguous program message and response message syntactic structures and standard status reporting structures.

Appendix C contains additional information for the Standard Commands for Programmable Instrumentation (SCPI) that is not covered in detail in this section of the manual. First is a number of figures representing the SCPI Command set of the Model 395 given in a “Command Tree” rather than the common “Command Table” format followed by the “SCPI Conformance Information” required by the specification. Finally, this appendix includes the common “Command Table” format.

---

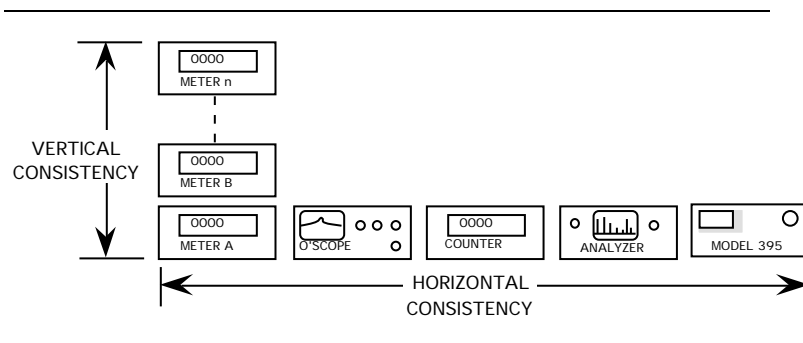
## 5.2 SCPI PRIMER

SCPI (Standard Commands for Programmable Instruments) traces its lineage to IEEE 488.1 and IEEE 488.2. Although the IEEE 488.2 standard addressed some instrument measurements, it principally dealt with common commands and syntax or data formats. Please refer to the IEEE 488.2 and SCPI reference manuals for more information.

The IEEE 488.1 relates to the physical connection between the instrument and its remote control unit; how the data is transmitted between the two; and the method used to determine master and slave.

The IEEE 488.2 encompassed and built upon IEEE 488.1 by adding syntax and data requirements for the communication path. In addition, it also defined the commands which were to be common to any and all units, and the query format for data retrieval from the remote instrument.

With SCPI, a variety of modular instruments have a universal language, even though they have different functions and manufacturers. SCPI added the fine detail of instrument setup by establishing a hierarchy of standard command formats and subsystem routing, reducing multiple ways to control similar functions. An example of vertical consistency (same instrument type) would be multimeters from different manufacturers implementing the command to measure a value of DC voltage in the same manner using the *Measure sub-system*. An example of horizontal consistency (different instrument types) would be different instruments using the same command to trigger a function using the *Trigger subsystem*. Refer to Figure 5-1. Queries of the instrument by the controller result in well-defined status response and measurement data. By building on the IEEE 488.2, all of the earlier commands that it had defined have become a part of SCPI and, to the limit that an instrument can be operated by them, they are valid.



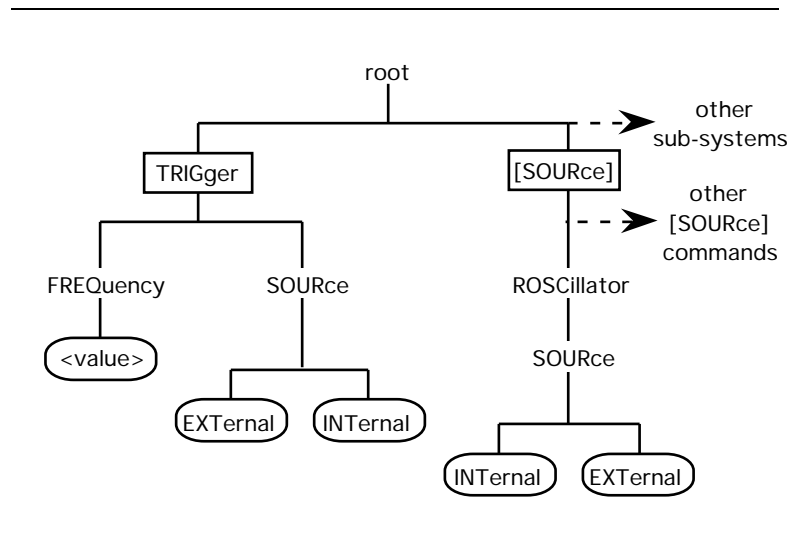
**Figure 5-1. Command Consistency**

The user need not be concerned about the interface commands, the common commands or the syntax and data structures, they are IEEE 488.1 and IEEE 488.2 definitions and have not changed; they are encompassed within SCPI. Not all instruments use all commands, but all instruments use the same command format.

Using the language rules and the hierarchical nature of the command structure, new commands, parameters, and subsystems can be developed from the existing primitive elements and commands as new instruments are introduced.

The hierarchy of subsystem commands in SCPI is called a **Command Tree** (sometimes also called a **Command Flow Chart**). The SCPI Command Tree is up-side-down, the Root is at the top with branches extending downward, ending with the parameter required for the branch function. Refer to Figure 5-2.

There is only one route to travel to reach the destination keyword or parameter on the selected branch. More than one command may have the same keyword, but on different branches. These commands usually perform a similar function in the respective branches, however, each can only be reached by traversing a unique path.



**Figure 5-2. Same Keywords in Different Subsystems**

The command hierarchy can also be represented by a **Command Table** and by **Syntax Diagrams**. An example of each method is illustrated.

### 5.2.1 Parameters

The parameter specifies the finest detail that is required in a branch. Most parameters have a defined default value at power-up or **\*RST**. Parameter defaults are specified in the manual for each instrument. There are three major types of parameters: *Character* (Discrete), *Decimal Numeric*, and *Boolean*.

*Character* parameters are a one word character label, usually one of a number choices, that defines a characteristic (e.g. ZCROs - the abbreviation for Zero Crossings). Failure to include a numerical suffix with a *Character* parameter requiring one, will result in issuing a command with the lowest value suffix (e.g. the command TTLTrg without any suffix will default to TTLTrg0).

*Decimal Numeric* has an extended set that may be implemented. *Decimal Numeric* may not be used as a subset (e.g. 1 of n lines), but may be used as a value definition (e.g. start value = 10). Subsets are implemented by using a suffix with a discrete (e.g. Line2). *Decimal Numeric* also covers the “label” type of parameter, the signal name (e.g. SIN1). The extended numeric set covers the special numbers MAXimum and MINimum which are required and DEFault which is optional.

---

*Boolean* parameters can have one of two values, usually ON or OFF. *Boolean* values can also be represented by “1” or “0” on the command line. Queries requesting a *Boolean* value will always return either “1” or a “0”.

A SCPI convention shows parameters in text and on the Command Tree with angle brackets (<>) if they are values or names to be entered by the user. Parameters with a character (discrete) keyword or Boolean parameters do not use the angle brackets. A Wavetek convention shows parameters in the command tree enclosed within an oval “box”. The default parameters that are selected at power-up or **\*RST** are shown in shaded oval “boxes”.

### 5.2.2 Queries

Any command that sets a value, can be queried about the current value of the setting. The query form of the command ends with a question mark (?). Some commands are defined as queries only and can be identified by the question mark used after them in the command tree. Some commands are events only and do not have a query form. These can usually be identified by their action nature such as DELete or IMMEDIATE. The values of the special numbers of MAXimum, MINimum, and DEFault may also be queried.

### 5.2.3 SCPI Punctuation and Syntax

Keywords can be abbreviated or used in full. SCPI requires the exact abbreviation or the exact full spelling only; capital or lower case letters have equal weight. The long form of the keyword may be either a single word or a phrase which has been abbreviated to a single word. The SCPI convention is to use the entire keyword in any text or instructions with the accepted abbreviation shown in capital letters. In addition, Wavetek makes the capital portion **bold** to show the minimum command requirements at a glance, and sets it off by using a different typeface. For example,

#### **FRE**quency

Common commands must start with an asterisk (\*). SCPI commands start with an optional colon (:). Each time a colon is inserted in the command line, the “pointer” is instructed to move down the branch which has the keyword immediately following. A semicolon (;) separates a string of commands on one line. If a colon does not follow the semicolon, the “pointer” remains at the same level. A colon following the semicolon will set the “pointer” back to the root. The commands do not become effective until a “Program Message Terminator” is received at the end of the command line. An incorrect command line will generate an error message.

### 5.2.4 Condensed Rules:

- Power-on and Reset

After power is applied, the command “pointer” is set to the root and all parameters to default values (**\*RST** does not set the Trace memory to default values).

- Command line termination

When the command line is terminated with a Program Message Terminator, the “pointer” is set to the root level.



---

- Colon

The optional leading colon in a command line indicates the keyword immediately following is at the root level (a subsystem).

A colon between command keywords indicates the pointer is to step down one level to the immediately following keyword.

- Semicolon

The semicolon separates commands within the same message without changing levels.

- Whitespace (space bar or tab)

Whitespace must be used to separate commands from parameters. Whitespace must not be used within a command keyword. Otherwise, SCPI usually ignores the whitespace.

- Comma

When a command requires a series of parameters, they must be separated by commas.

- Question Mark

The question mark is placed after the program header creating a query. A parameter may be placed after the question mark where appropriate (for example, ...LIMits? <trace name>). Some event commands do not have a query form (for example, DELete). Some commands are queries only (for example FREE?).

- Common Commands

Common commands (\*RST, \*TRG, etc.) are acted upon the same way regardless of which subsystem or into which level of the SCPI test program they are written. After execution of the common command, the SCPI command "pointer" will return to the point where it was interrupted (the exception is \*CLS, the "pointer" is set back to the root). The \*RST command will reset all subsystems to the default values except the Trace memory; it does not set the "pointer" back to the root.

## 5.2.5 Text Symbols

- Square brackets

Commands or portions of parameters that are optional are enclosed by square brackets ([ ]).

- Angle brackets

Angle brackets (< >)enclose parameters that are to be entered by the user, usually either numeric label (names) or numeric data (levels, values).

- Vertical line

The vertical line ( | ) represents an "exclusive OR", one of the values shown must be used.

---

## TRACE NAMES (numeric label data)

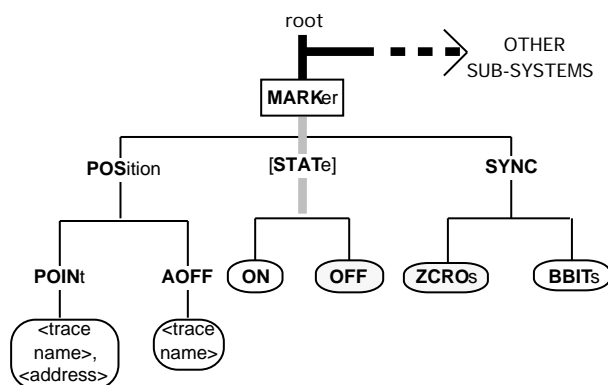
The following restrictions govern parameter names (user waveform names):

1. They cannot exceed 12 characters in length, preferred length is 4.
2. They must not have any embedded whitespace.
3. They *must* start with an alphabetic character. They cannot start with a numeric, a whitespace, or an underscore.
4. All alphanumeric characters may be used, both upper and lower case. The underscore ( `_` ) may also be used.
5. There is no abbreviation for the users trace name, it must be used as defined.

The command hierarchy can be represented in three ways; the **COMMAND TREE**, the **COMMAND TABLE**, or the **COMMAND SYNTAX DIAGRAM**. All three are illustrated on the following pages. Refer to Figure 5-3, the Example Command Tree.

### 5.2.6 Example (Hypothetical) Command Tree

---



---

**Figure 5-3. Example (Marker Subsystem) Command Tree**

Example command lines for this subsystem follow. Assume a trace name and size have been entered and a trace name is currently selected. Only the entered trace name is acted upon by the commands except in the case of global commands like **DELeTe:ALL** or **MODE**, etc. The long form of the keywords are given with the approved (or Wavetek selected) abbreviations in capitals. Items in **bold**, with the exception of optional commands, are minimum requirements.

The first character on the command line is the colon (:). This places the “pointer” at the “root” and just above all subsystems. The leading colon is optional if the command pointer is already at the “root”. The following example shows the development of the command line by “walking” down the tree. Select the **MARKer** subsystem by entering:

**:MARKer**

---

There are three branches in the Marker subsystem, select SYNC by entering it after MARKer:

**:MARKer:SYNC**

Sync has two discrete type parameters. Select one, ZCROs. Enter a <space>, then ZCROs, then a <program message terminator> (<PMT>). The <PMT> is not normally shown in command lines, but is shown below for reference. The PMT will enter the command string into the controller.

**:MARKer:SYNC ZCROs <PMT>**

If, after setting markers at various locations in the waveform, the markers are in unacceptable locations, turn them All Off using the AOFF sub-command (AOFF has no abbreviations).

**:MARKer:POStion:AOFF <trace name>**

Now, set the marker(s) to the position(s) desired. This command sets only one marker position (high) at a time; if more than one is desired, repeat the command for each position. There must *not* be any whitespace between the comma and either parameter. The <address> is a numeric value.

**:MARKer:POStion:POINt <trace name>,<address>**

The desired marker selections have been completed. Now, turn the marker ON. This command can use one of several formats, the complete command follows:

**:MARKer:STATe ON**

Because the STATe command is optional (the square brackets, [ ], in the command tree show this) it is not necessary to be entered on the command line:

**:MARKer ON**

Because the ON parameter is Boolean, it can be replaced by "1", if desired:

**:MARKer:STATe 1**

Both of the options have been exercised in the following command line. The syntax selected for the command depends upon the user.

**:MARKer 1**

Not including the query, the commands could have been entered in a string of four commands on one program line, using the semicolon and colon, as follows:

**:MARKer:SYNC ZCROs;POStion:AOFF <trace name>;POINt <trace name>,<address>;:Marker 1**

Enter a request for the marker state (this does not change the state).

**:MARKer:STATe? or :MARKer?**

Because the marker has been turned ON, the Boolean response will be:

**1**

---

## 5.2.7 Example Command Table

The command tree can also be presented as a table. The hypothetical instrument command tree portion of Figure 5-3 is shown below as Table 5-1. The symbols used with the tree are also used with the table.

The angle brackets (< >) indicate the parameter is entered by the user. Lower case text between the angle brackets show the parameter that is expected. ON/OFF are Boolean parameters. Discrete parameters often appear as command keywords in the command table, but must not be confused; a whitespace is still required before them on the command line. All parameters have manufacturer specified default values which will exist at power-up or \*RST. Numerical values entered, which are out of range for the branch, will not be acted upon and will return an error when the SYSTem:ERRor? query is sent.

The square brackets ( [ ] ) are optional commands that are not required in the command line, but may be used for documentation clarity. Some parameters or portions of parameters may be optional and will be shown with square brackets around them.

**Table 5-1. EXAMPLE MARKER COMMAND TABLE**

COMMAND	PARAMETERS	PARAMETER TYPE
:MARKer		
POSition		
POINT	<name> <address>	numeric (label) numeric
AOFF	<name>	numeric (label)
[STATE]	state (optional)	Boolean
SYNC	sync detector type	discrete

Under the “Command” heading in the table, the subsystem command is not indented. Each sub-command is indented showing the level of subordination. The Parameter column indicates the parameter expected for the command. The Parameter Type column shows the type of parameter for the sub-command.

## 5.2.8 Example Command Syntax Diagrams

The command list can also be presented as a syntax (or *railroad*) diagram. The hypothetical instrument command tree in Figure 5-3 is shown on the following pages as railroad diagrams. Some symbols used with the tree are also used with the diagram.

Railroad diagrams (so called because they look like railroad layouts from above) are another way to present the command flow. There is a railroad diagram for each command in a subsystem. As with the command tree and the command table, railroad diagrams have some unique symbols.

---

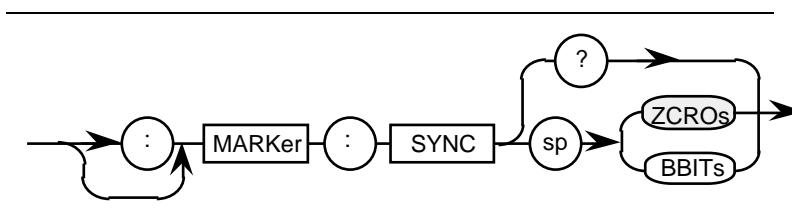
**MARKer** The rectangular box contains command and subsystem keywords with their abbreviation in capital letters.

**ON** The oval “boxes” contain parameters; shaded boxes are default. The angle brackets (< >) contain user entered parameters.

**:** The circle encloses punctuation (“sp” implies whitespace).

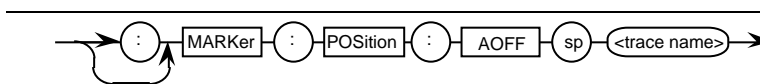
**→** The arrow shows the command direction flow. The flow is usually from left to right, but the command may contain loops flowing in other directions.

Figure 5-4 shows how the sync is selected, the query form, and the parameters available using the “railroad” syntax diagram format. The bypass around the leading colon indicates it is optional in the command line. The default parameter is shown by the shading. At each place the line splits, a decision must be made which path will be followed. The command is completed when the exit arrow has been reached.



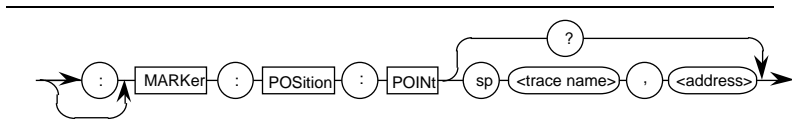
**Figure 5-4. Sync Selection**

Figure 5-5 shows the All Off command. There is no query form of the command, AOFF is an event.



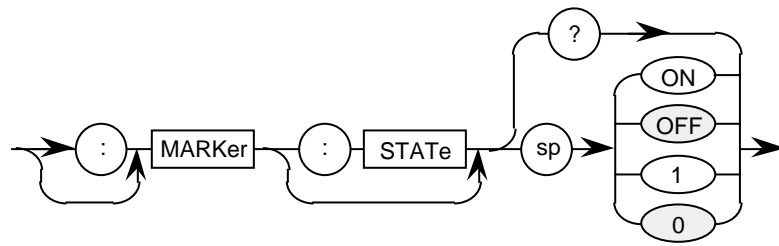
**Figure 5-5. All markers OFF command**

Figure 5-6 shows the command for setting the point address.



**Figure 5-6. Set Marker Point Address**

Figure 5-7 shows the bypass around the optional STAtE command. The entire Boolean parameter compliment is in the diagram with both OFF and “0” shown as default. The OFF parameter is equal to “0”, and ON is equal to “1”; equal parameters are interchangeable in the command line.



**Figure 5-7. Set the marker state.**

The query to show the output state will only return the Boolean values of “1” or “0.”

---

## 5.3 REMOTE RS-232 SETUP

Operating the Model 395 via RS-232 consists of three steps: hardware setup, instrument setup, and SCPI commands.

### 5.3.1 Hardware Setup

Paragraph 2.7.1 describes the Model 395 RS-232 hardware connections. Wavetek-Datron ships the Model 395 with a standard RS-232 (interface type E) cable (P/N 6002-00-0061) and adapter (P/N 2100-02-0328).

### 5.3.2 Instrument Setup

Press the REMOTE key to display the Remote Status screen; see figure 5-9. From the remote screen press F3 - "RS-232" For a complete listing of the Model 395 command set, refer to Table C-1, "Model 395 Command Syntax" in Appendix C. For descriptions, refer to paragraph 5.6, SCPI Commands.

---

F1	REMOTE STATUS: local	F5
F2	◇ IEEE-488 setup ... ◇	F6
F3	◆ RS-232 setup ... ◇	F7
F4	◇ keys ... go-local ◇	F8

---

**Figure 5-8. Remote Selection Screen.**

From the remote screen, press F7 "Setup..." to go to the RS-232 Setup screen.

---

F1	◇ echo: off	F5
F2	◇ handshake: off	F6
F3	◇ timeout: 2.0 sec	F7
F4	▲ baud: 9600 done ◇	F8

---

**Figure 5-9. RS-232 Setup Screen.**

### Baud Rate

RS-232C Baud rates: 57.6K, 38.4K, 19.2K, 9600, 4800, 2400, and 1200. From the list select Baud rate to match the remote device connected to the port.

### Echo

Press F1 to switch between "Echo Off" and "Echo On." With Echo On the Model 395 echoes (returns) any characters or commands sent to it from the "terminal." Also with Echo On, the Model 395 will send "enter command>" after executing a command. If Echo Off is selected, the Model 395 will not return commands or characters.

### Handshaking

Press F2 to turn hardware handshaking "On" and "Off." For details on hardware handshaking, refer to paragraph 2.7.1 in this manual.

---

## 5.4 IEEE-488.1 (GPIB) SETUP

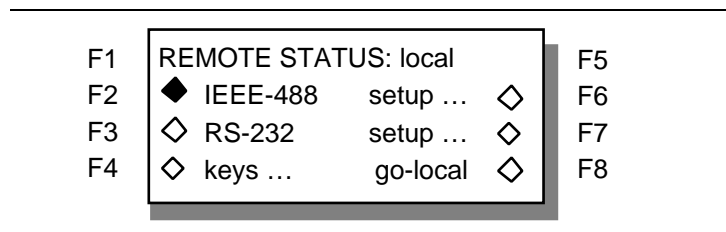
Operating the Model 395 via IEEE-488 consists of three steps: hardware setup, instrument setup, and commands. If the unit does not contain an IEEE interface, the IEEE-488 screens will not appear on the menu.

### 5.4.1 Hardware Setup

Paragraph 2.7.2 describes the Model 395's IEEE-488 hardware connections. The IEEE-488 cable sets are available from Wavetek-Datron in 1 meter (P/N 630364) and 2 meter (P/N 630366) lengths.

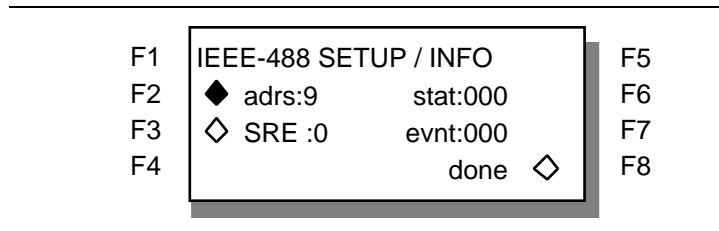
### 5.4.2 Instrument Setup

Press the REMOTE key on the front panel to display the remote screen (refer to figure 5-10). From the remote screen press F2 to select "IEEE-488". For a complete listing of the Model 395 command set, refer to Table C-1, "Model 395 Command Syntax" in Appendix C. For descriptions, refer to paragraph 5.6, SCPI Commands.



**Figure 5-10. Remote Selection Screen.**

From the remote screen, press F6 "Setup..." to go to the IEEE-488 Setup screen.



**Figure 5-11. IEEE-488 Setup Screen.**

### Address

Change the IEEE-488 address by pressing F2 "Adrs". Then use the front panel knob or keypad to change the address to match the external controller

### Service Request Enable

Press F3 "SRE" and use the front panel knob or keypad to enter a value between 0 and 255.



---

## Status

“Stat” displays the value of the Status Byte and Master Summary Status bit. The value is a decimal number between 0 and 255. Refer to \*STB in paragraph 5.7, IEEE-488 Common Commands.

## Event

“Evt” displays a value representing the contents of the Standard Event Status Enable Register. The value is a decimal number between 0 and 255. Refer to \*ESE in paragraph 5.7, IEEE-488 Common Commands.

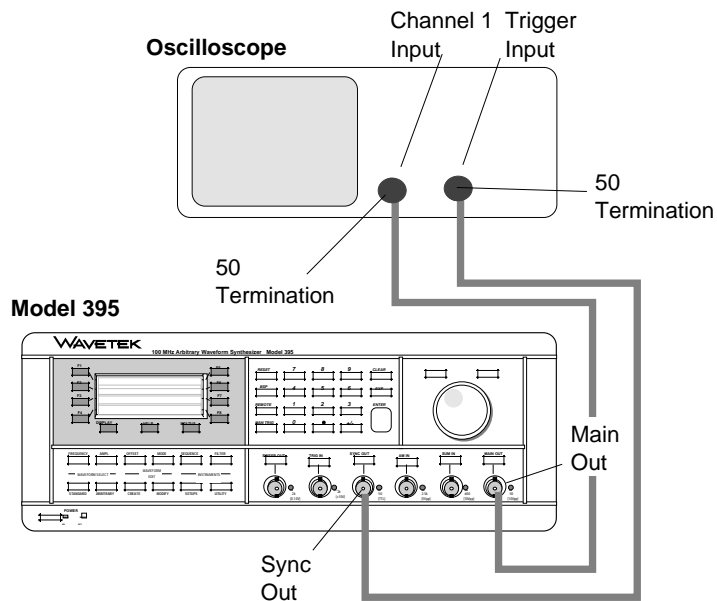
## 5.5 SCPI PROGRAMMING EXAMPLES

Paragraph 5.5 contains a collection of SCPI programming examples. These examples program the Model 395 to the same conditions as in paragraph 3.6 through 3.15; thus you can refer to these paragraphs if needed.

### Initial Setup

Before operating the Model 395, connect the Model 395 to the correct AC power source; see section 2 - Initial Turn-On. Make sure the fuse in the instrument matches the fuse required for your primary power source voltage. See Section 2, Preparation for Use, Fuse Replacement. Also, be sure the specified line voltage of the unit matches the primary power source. Use the power cord supplied with the unit to connect the Model 395 to the primary power source.

Use the correct cables and terminations to connect the Model 395 to an oscilloscope. Figure 5-12 illustrates a typical setup that connects the Model 395 Main Out to channel 1 on the oscilloscope, and the Sync Out to the scope trigger input. Cables from both outputs must be terminated with 50  $\Omega$ . Some scopes contain built-in 50  $\Omega$  terminations.



**Figure 5-12 . Model 395 to Scope Interconnection**

Connect the Model 395 to an instrument controller, such as a computer, that sends SCPI commands via RS-232 or IEEE-488 (option 001 - IEEE-488 Interface/Direct Waveform Transfer). Setup the interface as described in paragraph 5.3 (RS-232) or 5.4 (IEEE-488).

### 5.5.1 Model 395 As a Function Generator

As a function generator, the Model 395 generates sine, square, triangle, positive ramp, negative ramp, positive haversine, negative haversine,  $\sin(x)/x$ , and dc waveforms with programmable amplitudes to 10 Vp-p.

#### Example 1. Setting Up the Function Generator

This example sets up the Model 395 to produce a continuous, 4.58 MHz, 5.4 Vp-p square wave with a -1.2 Vdc offset; see figure 5-13. This example is the SCPI equivalent of example 1 in paragraph 3.6.

#### Note

The following commands are shown on separate lines for clarity. When sending actual command strings, the commands can be one continuous string with the program message terminator, <pmt>, at the end.

---

First, connect the Model 395, the scope, and the "controller" as described in "Initial Setup" of paragraph 5.5.

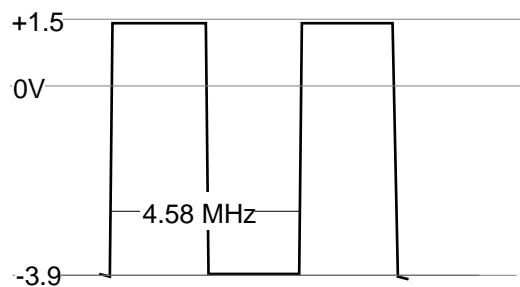
Then, send these commands:

```
*RST;  
[:SOURce]:FUNCTion[:SHAPE] SQUARE;  
:FREQuency 4.58e6;  
:VOLTagE[:LEVel][:IMM][:AMPL] 2.70;  
:VOLTagE:OFFSet -1.20; <pmt>
```

Finally, display the waveform by sending:

```
:OUTPut[:STATe] 1;OUTPut:SYNC[:STATe] 1;  
:INITiate:CONTinuous 1;
```

---



**Figure 5-13. Square Wave Output**

## 5.5.2 Model 395 as an Arbitrary Waveform Generator

Arbitrary waveform generators create and output custom waveforms. This paragraph guides you through the creation of three Arbitrary waveforms. One waveform, "gray," (example 2) creates an Arb waveform using line draw. The other two Arb waveforms, "sync1" (example 4) and "sync2" (example 5) will be used with waveform sequencing (paragraph 5.5.3). "sync1" uses waveform insert editing, and "sync2" uses point editing.

### Example 2 Creating an Arbitrary Waveform Using Line Draw

This example creates a waveform that simulates a nine-step gray scale video signal (figure 5-14). Example 3 outputs this waveform example. This example is the SCPI equivalent of example 2 in paragraph 3.7.

#### Note

The following commands are shown on separate lines for clarity. When sending actual command strings, commands can be one continuous string ending the program message terminator, <pmt>.

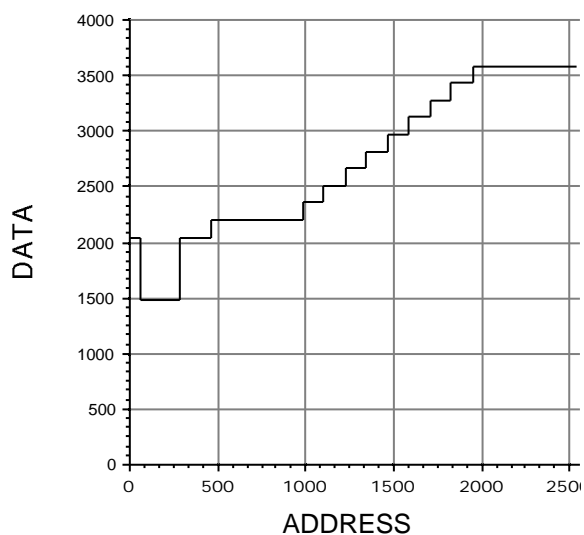
First, connect the Model 395, the scope, and the "controller" as described in paragraph 5.5, Initial Setup.

---

Next, create the waveform by sending these commands:

```
*RST;
:TRACE:DEFine gray2, 2540;
:TRACE:LINE gray2, 0, 2048 , 59 , 2048;
  LINE gray2 , 60 , 1471 , 280 , 1471;
  LINE gray2 , 281 , 2048 , 461 , 2048;
  LINE gray2 , 462 , 2202 , 981 , 2202;
  LINE gray2 , 982 , 2356 , 1102 , 2356;
  LINE gray2 , 1103 , 2510, 1223 , 2510;
  LINE gray2 , 1224 , 2664 , 1344 , 2664;
  LINE gray2 , 1345 , 2818 , 1465 , 2818;
  LINE gray2 , 1466 , 2972 , 1586 , 2972;
  LINE gray2 , 1587 , 3126, 1707 , 3126;
  LINE gray2 , 1708 , 3280 , 1827 , 3280;
  LINE gray2 , 1828 , 3434 , 1949 , 3434;
  LINE gray2 , 1950 , 3588 , 2539 , 3588; <pmt>
```

---



**Figure 5-14. Waveform : “gray”**

### **Example 3 Running the Arb Waveform**

Now that the Arbitrary waveform “gray2” has been created, you can output it like a standard waveform. This example is the SCPI equivalent of example 3 in paragraph 3.7.

#### **Note**

The following commands are shown on separate lines for clarity. When sending actual command strings, commands can be one continuous string with the program message terminator <pmt> at the end.

First, connect the Model 395, the scope and the "controller" as described in "Initial Setup," paragraph 5.5.

---

Then, send these commands:

```
*RST;
:OUTPut[:STATe] 1;
:OUTPut:SYNC[:STATe] 1;
:SOURce:FUNCTion gray2;
:SOURce:VOLTagE 2.70;
:SOURce:VOLTagE:OFFSet -0.05;
:SOURce:FREQuency:RASTer 4e7 <pmt>
```

The scope should display a waveform similar to figure 5-14.

#### **Example 4. Creating an Arb Waveform Using Waveform Insert**

The waveform, sync1, a 120 point square wave created using Wave Insert editing. The waveform, sync1, will be used in example 6, Creating a Sequence. This example is the SCPI equivalent of example 4 in paragraph 3.7.

##### Note

The following commands are shown on separate lines for clarity.  
But the actual command string can be send as one continuous string ending with the program message terminator <pmt>.

```
*RST
:OUTPut[:STATe] 1;
:OUTPut:SYNC[:STATe] 1;
:OUTPut:SYNC:SOUR PMARker;
:TRACE:DEFine sync1,120;
  LIMits sync1,000000,000119;
  DATA sync1,SQUare;
:SOURce:MARKer:POSition:POINT sync1,0;
  POINT sync1,1;POINT sync1,2;
  POINT sync1,3;POINT sync1,4;
  POINT sync1,5;POINT sync1,6;
  POINT sync1,7;POINT sync1,8,
  POINT sync1,9;POINT sync1,10; <pmt>
```

#### **Example 5. Creating an Arbitrary Waveform Using Point Edit**

The waveform, sync2, is a 40 point arbitrary waveform created using point edit; see figure 5-15. Example 6 uses "sync2" as part of its sequence. This example is the SCPI equivalent of example 5 in paragraph 3.7.



**Figure 5-15. Sync2 Waveform**

**Note**

The following commands are shown on separate lines for clarity. When sending the actual command string, the commands can be strung into one continuous string with the program message terminator <pmt> at the end.

To create this waveform, send the following commands:

```
*RST;
:TRACe:DEFine sync2,40;
:TRACe:LIMits sync2,0,39;
:Trace:[DATA]:POINT sync2,0,0;
  POINT sync2,1,2000;
  POINT sync2,2,2000;
  POINT sync2,3,4000;
  POINT sync2,4,4000;
  POINT sync2,5,4000;
  POINT sync2,6,4000;
  POINT sync2,6,4000;
  POINT sync2,7,4000;
  POINT sync2,8,4000;
  POINT sync2,9,4000;
  POINT sync2,10,4000;
  POINT sync2,11,4000;
  POINT sync2,12,4000;
  POINT sync2,13,4000;
  POINT sync2,14,4000;
  POINT sync2,15,4000;
  POINT sync2,16,4000;
  POINT sync2,17,4000;
  POINT sync2,18,4000;
  POINT sync2,19,4000;
```

---

```

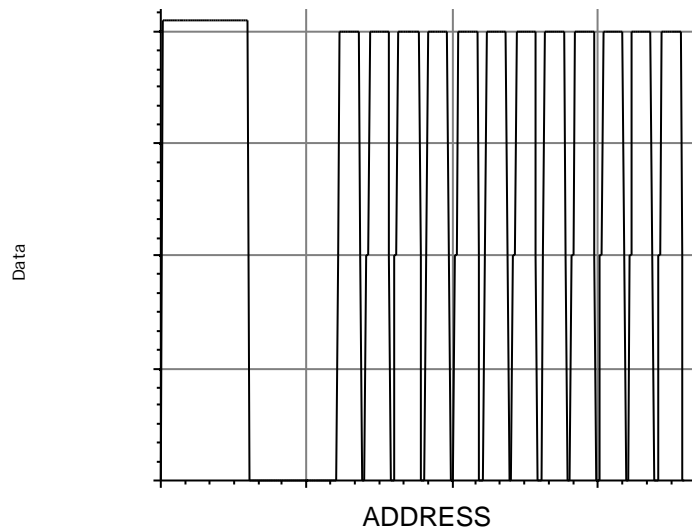
POINT sync2,20,4000;
POINT sync2,22,4000;
POINT sync2,23,4000;
POINT sync2,24,4000;
POINT sync2,25,4000;
POINT sync2,26,4000;
POINT sync2,27,4000;
POINT sync2,28,4000;
POINT sync2,29,4000;
POINT sync2,30,4000;
POINT sync2,31,2000;
POINT sync2,32,2000;
POINT sync2,33,4000;
POINT sync2,34,4000;
POINT sync2,35,4000;
POINT sync2,36,4000;
POINT sync2,37,2000;
POINT sync2,38,0000;
POINT sync2,39,0000; <pmt>

```

### 5.5.3 The Model 395 as a Waveform Sequence Generator

#### Example 6 Creating a Waveform Sequence

This sequence combines the waveforms you created in examples 4 and 5 (sync1 and sync2) to form a waveform sequence which simulates a vertical sync signal used in video applications. See figure 5-16. This example is the SCPI equivalent of example 6 in paragraph 3.8.



**Figure 5-16. Sequence Example**

#### Note

The following commands are shown as separate lines for clarity. When sending actual command strings, commands can be one continuous string with the program message terminator, *<pmt>*, at the end.

---

First, connect the Model 395, the scope, and the "controller" as described in "Initial Setup" of paragraph 5.5.

Then, send these commands to set up the sequence:

```
*RST
[:SOURce]:SEQuence:LENGth 2;
[:SOURce]:SEQuence:FUNCTion sync1,0;
    FUNCTion sync2,1;
[:SOURce]:SEQuence:ADVance AUTO,0;
    ADVance AUTO,1;
[:SOURce]:SEQuence:DWELl 12,1
```

Output the sequence by sending these commands:

```
[:SOURce]:FUNCTion:MODE SEQuence
:OUTPut[:STATe] 1;
:OUTPut:SYNC 1;
:OUTPut:SYNC:SOURce PMAR; <pmt>
```

## 5.5.4 Storing and Recalling Setups

### Example 7. Storing and Recalling an Instrument Setup

This example stores the "running" sequence created using example 6. This example is the SCPI equivalent of example 7 in paragraph 3.9.

Store the current instrument setup as "sync" by sending these commands:

```
:MMEMory:STORe[:SETup] sync <pmt>
```

Recall the setup named "sync" by sending these commands:

```
:MMEMory:LOAD[:SETup] sync <pmt>
```

## 5.5.5 The Model 395 As a Sweep Generator

### Example 8. Setting up the Sweep Generator

This example creates a 5 second, 200 kHz and 400 kHz triggered sweep waveform that is triggered by the internal trigger source (15 second rate) of the Model 395. This example is the SCPI equivalent of example 8 in paragraph 3.10.

#### Note

The following commands are shown on separate lines for clarity. But when sending the actual command string, you can string the commands a continuous string which ends with the program message terminator, <pmt>.

First, connect the Model 395, the scope and, the "controller" as described in "Initial Setup" of paragraph 5.5.



---

Then, send these commands:

```
*RST;
:TRIGger:SOURce:[START] INTernal;
:TRIGger:TIMER:[START] 15;
[:SOURce]:SWEep:MODE TRReset;
SWEep:TIME 5;
:SOURce:FREQuency:START 2e5;
:SOURce:FREQuency:STOP 4e5;
:SOURce:FREQuency:MODE SWEep; <pmt>
```

Then, send these commands:

```
:OUTPut ON;:OUTP:SYNC[:STATe] ON; <pmt>
```

## 5.5.6 The Model 395 as a Trigger Generator

### Example 9 Setting up the Triggered Generator

This example sets up the Model 395 to generate, when triggered, five 300 Hz, Sin (x)/x waveforms. Trigger the Model 395 by sending remote commands. This example is the SCPI equivalent of example 9 in paragraph 3.11.

#### Note

The example are shown on separate lines for clarity. When sending actual command strings, the commands can be one continuous string with a program message terminator <pmt> at the end.

First, connect the Model 395, the scope, and the "controller" as described in "Initial Setup" - paragraph 5.5.

Second, send the following commands:

```
:RESet;
:INITiate:CONTInuous OFF;
:TRIGger:SOURce[:START] MANual;
:TRIGger:COUNT 5;
:FREQuency 300;
:FUNCTion[:SHAPE] sinc; <pmt>
```

Then, send these commands:

```
:OUTPut[:STATe] 1;:OUTPut:SYNC[:STATe] 1; <pmt>
```

Finally, trigger the Model 395 by sending:

```
:TRIGger[:IMMediate]; <pmt>
```

or

```
*TRG
```

---

## 5.5.7 The Model 395 as a Pulse Generator

### Example 10 Setting up the Pulse Waveform

Use this example to set up the Model 395 to generate a continuous 10  $\mu\text{s}$  (period), 1  $\mu\text{s}$  wide pulse with fixed rise/fall edges and delayed 2  $\mu\text{s}$  relative to the Sync Out signal. See figure 5-17. This example is the SCPI equivalent of example 10 in paragraph 3.10.

#### Note

For clarity the following commands are shown on separate lines. But when sending actual command strings, the commands can be sent as one continuous string with a program message terminator, *<pmt>*, at the end.

First, send the following commands to set up the pulse:

```
*RST;  
:[SOURce]:PULSe:PERiod 1e-5;  
  TRANsition[:STATe] OFF;  
:PULSe:WIDTh 1e-6;  
  DELay 2e-6;  
:VOLTage[:LEVel][:IMMediate]:HIGH 2.5;  
  LOW 0.0; <pmt>
```

Then, connect the Model 395, the scope, and the "controller" as described in paragraph 5.5, "Initial Setup." Finally, send these commands to "run" the pulse:

```
[:SOURce]:FUNction[:SHAPE] PULSe;  
:OUTPut[:STATe] 1;:OUTPut:SYNC[:STATe] 1; <pmt>
```

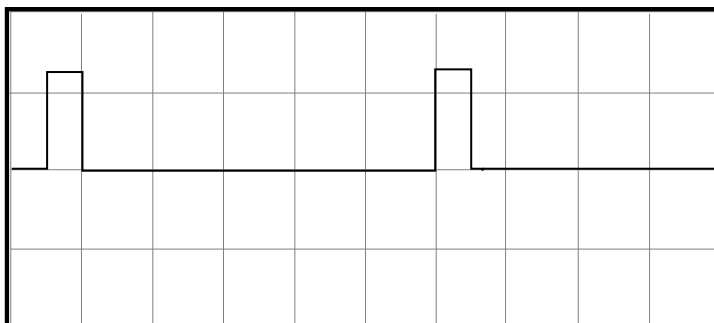


Figure 5-17. Pulse Example

### Example 11 Setting up the Pulse Train Waveform

This example sets up a pulse train. In this example you will create three pulses, each with their own widths, levels, and rise/fall times; see figure 5-18. This example is the SCPI equivalent of example 11 in paragraph 3.12.

#### Note

The following commands are shown on separate lines for clarity. When sending actual command strings, commands can be sent as one continuous string ending with a program message terminator *<pmt>*.

---

First, connect the Model 395, the scope, and the "controller" as described in "Initial Setup" of paragraph 5.5.

Second ,set up the pulse train by sending these commands:

```
*RST;
[:SOURCE]:FUNCTION:PTRAIN:COUNT 3;
FUNCTION:PTRAIN:BASELINE -4;
FUNCTION:PTRAIN:PERIOD 5e-1;
FUNCTION:PTRAIN:TRANSITION[:STATE] 1;
FUNCTION:PTRAIN:LEVEL 4 ,0;
FUNCTION:PTRAIN:TRANSITION:LEADING 32e-3 ,0;
FUNCTION:PTRAIN:TRANSITION:TRAILING 64e-3 ,0;
FUNCTION:PTRAIN:WIDTH 12e-2 ,0;
FUNCTION:PTRAIN:DELAY 40e-2 ,0;
FUNCTION:PTRAIN:LEVEL 2 ,1;
FUNCTION:PTRAIN:TRANSITION:LEADING 8e-3 ,1;
FUNCTION:PTRAIN:TRANSITION:TRAILING 8e-3 ,1;
FUNCTION:PTRAIN:WIDTH 6e-2 ,1;
FUNCTION:PTRAIN:DELAY 3e-1 , 1;
FUNCTION:PTRAIN:LEVEL -2 ,2;
FUNCTION:PTRAIN:TRANSITION:LEADING 8e-3 ,2;
FUNCTION:PTRAIN:TRANSITION:TRAILING 32e-3 ,2;
FUNCTION:PTRAIN:WIDTH 5e-2 ,2;
FUNCTION:PTRAIN:DELAY 42e-2 ,2; <pmt>
```

Finally, send these commands to output the pulse:

```
[:SOURCE]:FUNCTION[:SHAPE] PTRAIN;
:INITiate:CONTinuous;
:OUTPut[:STATE] 1;:OUTPut:SYNC[:STATE] 1; <pmt>
```



---

**Figure 5-18. Pulse Train Example**

---

## 5.5.8 The Model 395 as a Noise Generator

### Example 12 Setting Up the Signal To Noise Waveform

Example 12 creates a 100 kHz sine waveform with 50% peak to peak noise (figure 5-19). This example is the SCPI equivalent of example 12 in paragraph 3.13.

#### Note

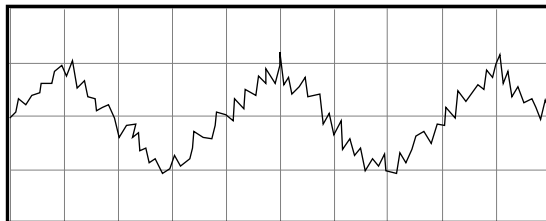
For clarity the following commands are shown on separate lines. But when sending actual command strings, you can send the commands as one continuous string with the program message terminator *<pmt>* at the end.

Connect the Model 395, the scope, and "controller" as described in paragraph 5.5, "Initial Setup." Then, set up the signal plus noise waveform by sending the following commands:

```
*RST;  
[:SOURCE]:FUNCTION:NOISE:SHAPE SPANoise;  
FUNCTION:NOISE:SLength 4095;  
FUNCTION:NOISE:FREQuence:START 1e5;  
FUNCTION:NOISE:FREQuence:STOP 2e6;  
FUNCTION:NOISE:SIGNAL:NAME SINusoid;  
FUNCTION:NOISE:SIGNAL:FREQuency 1e5;  
FUNCTION:NOISE:SIGNAL:RATio 50; <pmt>
```

Output the signal plus noise waveform by sending these commands:

```
[:SOURCE]:FUNCTION[:SHAPE] SPANoise;  
:INITiate:CONTinuous;  
:OUTPut[:STATE] 1;  
:OUTPut:SYNC[:STATE] 1; <pmt>
```



---

Figure 5-19. Signal Plus Noise Example

## 5.5.9 The Model 395 as an Amplitude Modulation Signal Source

### Example 13 Setting Up Amplitude Modulation

Example 13 produces a 600 kHz 50% Amplitude Modulated Sine wave using an external modulating source. See figure 5-20. This example is the SCPI equivalent of example 13 in paragraph 3.14.

#### Note

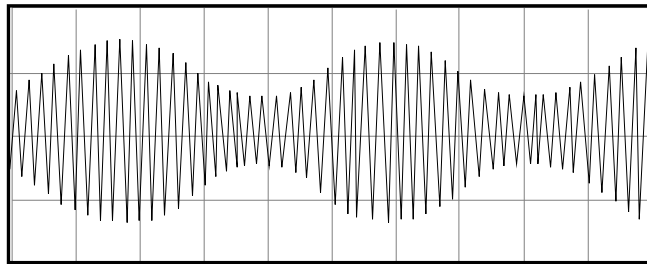
For clarity the following commands are shown on separate lines. But when sending actual command strings, you can send the commands as one continuous string with the program message terminator *<pmt>* at the end.

---

First, connect the Model 395, the scope, and the "controller" as described in paragraph 5.5, "Initial Setup." Send the following commands to set up the Model 395 for amplitude modulation:

```
:RESet ;  
[:SOURce]:FREQuency 6e5 ;  
[:SOURce]:AM:STATe on ;  
:OUTPut[:STATe] ON ;
```

Then, setup the external signal generator to 2 kHz, 1.25 Vp-p sine wave. Connect an external signal generator's output to the to the Model 395's AM IN connector and scope's sync input. Be sure to properly terminate the external signal generator's output.



---

**Figure 5-20. AM Example**

### 5.5.10 The Model 395 and its Summing Input

#### Example 14. Setting Up Summing Input

Example 14 sums an external TTL waveform with analog noise from the Model 395. This example is the SCPI equivalent of example 14 in paragraph 3.15.

##### Note

For clarity the following commands are shown on separate lines. But when sending actual command strings, you can send the commands as one continuous string with the program message terminator <pmt> at the end.

Connect the Model 395, the scope and, the "controller" as described in paragraph 5.5 "Initial Setup."

First, send the following commands to set up the analog noise:

```
:RESet ;  
[:SOURce]:FUNctIon:NOISe:SHAPE ANoise ;  
FUNctIon:NOISe:SLENgth 4095 ;  
FUNctIon:NOISe:FREQuency:START 1e2 ;  
FUNctIon:NOISe:FREQuency:STOP 2e6 ;  
FUNctIon[:SHAPE] ANoise ;<pmt>
```

---

Second, set up the Sum Input by sending these commands:

```
[ :SOURce ] :SUM [ :STATe ] ON ;  
:OUTPut :ATTenuator :MODE AUTO ;  
:OUTPut :ATTenuator :SELEct 0 ;
```

Connect the external Sum Source to the Model 395's Sum In connector, and set the signal source to 1 kHz, 2 Vp-p sine wave. Connect the Main Out from the Model 395 to channel 1 on the scope. Sync the scope from the Sum Source. Be sure to properly terminate the outputs from the Sum Source and Model 395.

Send these commands to enable the Main Out connector and display the summed signal on the scope:

```
OUTPut [ :STATe ] ON ;
```

---

## 5.6 SCPI COMMANDS

The following paragraphs describe the Model 395 SCPI program message set. A quick reference figure for each of the subsystems can be found in Figures 5-1 through 5-7.

### 5.6.1 ABORt

ABORt

Sending this program message has no affect on the Model 395.

### 5.6.2 CALibration

CALibration

```
[ :ALL]
[ :ALL]?
:DATA <block>
    :STORe
:ENABle <boolean>
:ENABle?
:STATe <boolean>
```

CALibration[:ALL]

Sending this program message performs a DC calibration of the output amplitude and offset voltage levels and stores the calibration data in nonvolatile memory. If the calibration is successful, use of the stored data is enabled for correction of programmed parameter values. If the calibration is unsuccessful for any reason, use of the stored data is disabled and default correction factors are used.

CALibration[:ALL]?

This query returns a value of 0 if the self-calibration is successful and a nonzero positive integer value if not. The response value will indicate the nature of the failure.



#### CALibration[:ALL?] Response Format

CALibration:DATA <block>

Sending this program message allows calibration data to be transferred directly to and from the memory in the form of Arbitrary Block Program Data. The CALibration:DATA:STORe program message must be used if data is to be transferred to the EEPROM.

CALibration:DATA:STORe

Sending this program message causes correction data that has been downloaded using the program messages in the CALibrate:DATA subsystem to be stored into nonvolatile memory. This should be done only after all correction data has been finalized so as to minimize writes to the EEPROM.

---

CALibration:ENABLE?

Sending the query returns the state of the rear panel Cal Enable switch. A 0 indicates the switch is in the "NORM" position. When a 1 is returned, the switch is set to "CAL."

CALibration:STATE <ON | OFF>

Sending this program message enables correction of the output amplitude and offset voltage levels using the calibration data stored in nonvolatile memory. If the calibration corrections are disabled then default corrections are used.

### 5.6.3 DISPlAY

DISPlay

```
[ :WINDow]
  :TEXT
    [:DATA] <string>
  :CLEar
  :UPDate
```

DISPlay:TEXT[:DATA] <string>

This command allows you to send a message to the display to provide information or an operator prompt. The message contained in the <string> characters is displayed on the screen. The message may be multi-line; you select line breaks with the backslash (\) character. The message can have a maximum of 4 lines of 20 characters each. Excess lines and characters can be viewed using the knob or cursor keys. Characters can be any standard ASCII value from "32" (space) to "125" (}). The message remains on the display until cleared with the DISPlay:TEXT:CLEar message. If a new TEXT command is sent while a previous one is still being displayed, the original TEXT box is automatically removed before the new one is displayed.

DISPlay:TEXT:CLEar

This command removes the message dialog box created by the DISPlay: TEXT <string> command.

DISPlay:UPDate

This command causes the front panel display to be redrawn, using the last current set of commands executed to determine which information should be displayed. Under normal remote operation, the display is not updated when the remote interface is "busy", and it may lag behind the current instrument setup.



---

## 5.6.4 INITiate

INITiate

[ :IMMEDIATE ]

:CONTinuous <Boolean>

INITiate[ :IMMEDIATE ]

This program message supports the SCPI language definition, but changes no setups within the Model 395.

INITiate:CONTinuous <ON | OFF>

Sending this program message selects between continuous mode of operation and a non-continuous mode of operation. In continuous, the selected trace or function is continuously output at the Main Out, using the (default) command:

```
INIT:CONT ON
```

Non-continuous modes include Triggered and Gated modes. Triggered mode outputs the selected trace or function for a number of cycles determined by the trigger COUNT once per triggering event at the Main Out, using the command:

```
INIT:CONT OFF;:TRIG:GATE OFF;:TRIG:COUN <value>
```

Gated mode causes the selected function or trace to be output while the trigger source is true, and quiescent while the source is false. There are two GATE submodes, as shown in the command:

```
INIT:CONT OFF;:TRIG:GATE ON;MODE <ASYN | SYNC>
```

## 5.6.5 MMEMory

MMEMory

:CATalog?

:DElete

[ :SETup ]

:DSO

:INITialize

:LOAD

[ :SETup ]

:STORE

[ :SETup ]

:DLOAD

[ :DSO ]

MMEMory:CATalog?

Sending the query returns the CATalog listing of the Model 395 internal memory. Returned format is <bytes\_used>,<bytes\_free>,name,size,name,size, ...

MMEMory:DElete[ :SETup ]<setup\_name>

Sending this command causes the *setup\_name* in memory to be deleted. The *setup\_name* must contain the file extension .SET to correctly identify the file.

MMEMory:DElete:DSO<DSO\_name>

Sending this command causes the *DSO\_name* in memory to be deleted. The file must contain the file extension ".DSO" to correctly identify the file.

---

MMEMory:INITialize

Sending the command clears the entire contents of the internal RAM.

MMEMory:LOAD[:SETup] <setup\_name>

Sending this program message recalls the stored instrument setup *setup\_name* from memory. The *setup\_name* must contain the file extension .SET to correctly identify the file.

This is the equivalent to using the IEEE-488 \*RCL command, except the <setup\_name> is a character string rather than a numeric value. *MMEMory:LOAD[:SETup] <setup\_name>* can load a file created by \*RCL by internally supplying an "S" prefix. For example:

\*RCL 172345

is equivalent to:

MMEM:LOAD:SET S172345

MMEMory:STORe[:SETup]<setup\_name>

Sending this program message stores the current instrument settings as "setup\_name.SET" to the internal memory. This the equivalent to using the IEEE-488 \*SAV command, except <setup\_name> is a character string rather than a numeric value. For example:

\*SAV 32

is equivalent to:

MMEM:STOR:SET S32

MMEMory:DLOad[:DSO]<DSO\_name>

Sending this program message uploads the DSO driver "DSO\_name.DSO" in to Model 395 memory. For details on the message format, refer to appendix F.

---

## 5.6.6 OUTPUT

### OUTPUT

```
:ATTenuation
    :MODE <AUTO | MANual>
    [:SElect] <0 , 42>
:FILTer
    [:LPASs]
        MODE <AUTO|MANual>
        [:SElect] <NFILter | EL20 | EL40 | BESSel>
[:STATe] <Boolean>
SYNC
    [:STATe] <Boolean>
    :MODE <AUTO | MANual>
    :SOURce <SYNCmarker | PMARker | BCOMplete |
        LCOMplete | TSource | SMARker | PENLift>
```

OUTPUT:ATTenuation:MODE <AUTO|MANual>

Sending this program message selects the automatic mode (default) or manual mode. Auto will change attenuators whenever the programmed amplitude or offset exceeds the attenuator's limits. Manual locks the Model 395 to the selected attenuator which will limit the upper limit to the limit of the programmed attenuator. However, the lower limit can programmed below the lowest limit of the programmed attenuator. Use this message with

:SOURce:SUM[:STATe <off | on>.

OUTPUT:ATTenuation[:SElect] <0 , 42>

Send this program message to program the output attenuator. Program the attenuator in dB: 0 (0dB or ÷1), 0 (0dB or ÷1), 6 (-6dB or ÷2), 12 (-12dB or ÷4), 18 (-18dB or ÷8), 24 (-24dB or ÷16), 30 (-30dB or ÷32), 36 (-36dB or ÷64), 42 (-42dB or ÷128). Use this message with

:SOURce:SUM[:STATe <off | on>.

OUTPUT:FILTer[:LPASs][:SElect] <NFILter | EL20 | EL40 | BESSel>

Sending this program message selects the filter type.

NFILter	Selects No Filter at the output.
EL20	Selects the 20 MHz elliptic filter.
EL40	Selects the 40 MHz elliptic filter.
BESSel	Selects the Bessel filter.

OUTPUT[:STATe] <ON | OFF>

Sending this program message enables or disables the signal to the MAIN OUT connector.

OUTPUT:SYNC[:STATe] <ON | OFF>

Sending this program message enables or disables the signal to the SYNC OUT connector.

OUTPUT:SYNC:SOURce <SYNCmarker | PMARker | BCOMplete | LCOMplete | TSource | SMARker | PENLift>

Sending this program message selects the signal for the Sync Out connector.

SYNCmarker Selects Waveform Sync as the source.

---

PMARker	Selects Position Marker as the source.
BCOMplete	Selects Burst Done as the source.
LCOMplete	Selects Loop Done as the source.
TSource	Selects Trigger as the source.
SMARker	Selects Sweep Marker as the source.
PENLift	Selects Pen Lift as the source.

### 5.6.7 RESet

#### RESet

Sending this program message resets all parameters to their default state. This program message has no effect on the TRACe subsystem. Following is a list of Model 395 defaults:

Amplitude	1 Vp
AM Mode	Off
Frequency	1 kHz
AM State	Off
Filter	20 MHz Elliptic
Filter Mode	Auto
Function Mode	Fixed
Function Shape	Sinusoid
Marker Position	0
Mode	Continuous
Offset	0.0 Vdc
Output	Off
Sequence Trigger	Edge
Sequence Advance	Auto
Sweep Direction	Up
Sweep Mode	Continuous Reset
Sweep Spacing	Linear
Sweep Start	1 kHz
Sweep Stop	10 kHz
Sweep Time	1 second
Sync Source	Sync Marker
Sync Output	Off
Trigger Count	1
Trigger Rate, Internal	5 ms
Trigger Source	Internal

---

## 5.6.8 [SOURce]

```
[SOURce]
  :AM
    :STATe <Boolean>
    :MODE <AM | SCM>
  :FREQuency
    [:CW | FIXed] <numeric_value>
    :MANual <numeric_value>
    :MODE <CW | FIXed | SWEep>
    :RASTer <numeric_value>
    :START <numeric_value>
    :STOP <numeric_value>
  :FUNction
    [:SHAPE] <shape_name>
    :USER <trace_name>
    :MODE <FIXed | SEQuence>
  :AM
    [:DEPTh] <numeric_value>
    :MODE <AM | SCM>
    :FREQuency
      [:CARRier] <numeric_value>
      :MODulation <numeric_value>
    :MSIGnal
      [NAME] <trace_name>
  :FM
    [:FREQuency]
      :CARRier <numeric_value>
      [:DEViation] <numeric_value>
      :MODulation <numeric_value>
    :MSIGnal
      [NAME] <trace_name>
  :NOISe
    :SHAPE <DNOise | ANoise | COMB | SPANoise | SPComb>
    :SLENgth <integer_numeric_value>
    :NTEeth <numeric_value>
    :FREQuency
      :START <real_numeric_value>
      :STOP <real_numeric_value>
    :SIGnal
      :NAME <shape_name>
      :FREQuency <real_numeric_value>
      :RATio <integer_numeric_value>
```

---

```

:PTRain
  :BASEline <real_numeric_value>
  :COUNT <integer_numeric_value>
  :PERiod <real_numeric_value>
  :LEVel <real_numeric_value>,
    <integer_numeric_value>
  :DELay <real_numeric_value>,
    <integer_numeric_value>
  :WIDTh <real_numeric_value>,
    <integer_numeric_value>
  :TRANSition
    [STATE] <Boolean>
    :LEADing <real_numeric_value>,
      <integer_numeric_value>
    :TRAILing <real_numeric_value>,
      <integer_numeric_value>
:MARKer
  [:POSITION]
    :AOFF <trace_name>
    :POINT <trace_name>,<point_index>
    :FREQuency <numeric_value>
:PULSe
  :PERiod <real_numeric_value>
  :DELay <real_numeric_value>
  :WIDTh <real_numeric_value>
  :TRANSition
    [:STATE] <Boolean>
    :LEADing <real_numeric_value>
    :TRAILing <real_numeric_value>
:SEQuence
  :ADVance <AUTO | TRIGgered>,<list_index>
  :DWELL <numeric_value>,<list_index>
  :FUNction <trace_name>,<list_index>
  :LENGth <numeric_value>
  :TRIGger
    :MODE <SYNChronous | ASYNchronous>
    :SENSe <EDGE | LEVel>
:SUM
  [STATE] <Boolean>
:SWEep
  :COUNT <numeric_value>
  :DIRection <UP | DOWN>
  :MODE <CRESet | TRESet | HRESet | CREVerse

```

---

```

|TREVerse|HREVerse|MANual>
:SPACing <LINear|LOGarithmic>
:TIME <numeric_value>
:VOLtage
[:LEVel]
[:IMMediate]
[:AMPLitude] <numeric_value>
:OFFSet <numeric_value>
:HIGH <numeric_value>
:LOW <numeric_value>

```

#### NOTE

The SCPI language considers “SOURce” to be a default program message.

#### [SOURce:]AM

[SOURce:]AM:STATe <OFF | ON>  
 Sending this program message enables or disables the external amplitude modulation input (AM IN).

[SOURce:]AM:MODE <AM | SCM>  
 Sending this program message selects the external amplitude modulation mode.

- AM Standard amplitude modulation.
- SCM Suppressed carrier amplitude modulation.

#### [SOURce:]FREQUENCY

[SOURce:]FREQUENCY[:CW ] <numeric\_value> **(1.0e3)**  
 Sending this program message controls the frequency of the function output when the Trace Mode is set to CW. Allowable values are 1e-6 to 50e6.

[SOURce:]FREQUENCY:MANual <numeric\_value> **(1.0e3)**  
 Sending this program message controls the frequency of the function output when [SOURce:]FREQUENCY:MODE SWEep and [SOURce:]SWEep:MODE MANual are selected. Allowable range is 1e-1 to 2e7.

[SOURce:]FREQUENCY:MODE <CW | SWEep>  
 Sending this program message controls the frequency sweep logic. If the frequency mode is set to CW then the output frequency of a standard function is determined by the programming of [SOURce:]FREQUENCY[:CW]. If the frequency mode is set to SWEep then the output frequency is swept from the start frequency to the stop frequency in the direction and time set by the sweep subsystem program messages.

[SOURce:]FREQUENCY:START <numeric\_value> **(1.0e3)**  
 Sending this program message controls the start frequency of the function output when the frequency mode is set to SWEep. Allowable range is 1e-3 to 2e7.

[SOURce:]FREQUENCY:STOP <numeric\_value> **(1.0e4)**  
 Sending this program message controls the stop frequency of the function output when the frequency mode is set to SWEep. Allowable range is 1e-3 to 2e7.

[SOURce:]FREQUENCY:RASTer <numeric\_value> **(5.0e7)**  
 Sending this program message controls the trace scan rate when the Trace Mode is set to RASTer. Allowable range is 1e-1 to 1e8.

---

## [SOURCE:]FUNCTION

[SOURCE:]FUNCTION:MODE <**FIXed** | SEQuence>

Sending this program message controls the function sequence logic. If the function mode is set to **FIXed** then the output function is [SOURCE:]FUNCTION[:SHAPE]. If the function mode is set to SEQuence then the output function is determined by the contents of the sequence table.

[SOURCE:]FUNCTION:AM[:DEPTH] <numeric-value>

Sending this program message set the percentage of modulation for AM. The value can be between 0 and 200 with 50 being the default. Selecting 200% AM is the same as SCM.

[SOURCE:]FUNCTION:AM:MODE <**AM** | SCM>

Sending this program message selects either the AM or SCM mode. In SCM the percent of modulation is fixed at 200%.

[SOURCE:]FUNCTION:AM[:CARRIER] <numeric-value>

Sending this program message sets the AM carrier frequency. Values can be programmed between 0.01 and 4e7 (Hz) with 1e6 as the default value.

[SOURCE:]FUNCTION:AM:MODulation <numeric-value>

Sending this program message sets the AM modulation frequency. Values can be programmed between 0.01 and 4e7 (Hz) with 1e3 as the default value.

[SOURCE:]FUNCTION:AM:MSIGNAL[:NAME] <trace\_name>

Sending this program message sets the AM modulating signal.

[SOURCE:]FUNCTION:FM[:FREQUENCY]:CARRIER <numeric\_value>

Sending this program message sets the FM carrier frequency. Values can be programmed between 0.01 and 4e7 (Hz) with 5e6 as the default value.

[SOURCE:]FUNCTION:FM[:FREQUENCY][:DEVIATION]  
<numeric\_value>

Sending this program message sets the FM frequency deviation. Values can be programmed between 0.01 and 4e7 (Hz) with 4e3 as the default value.

[SOURCE:]FUNCTION:FM[:FREQUENCY]:MODulation  
<numeric\_value>

Sending this program message sets the FM modulation frequency. Values can be programmed between 0.01 and 4e7 (Hz) with 20e7 as the default value.

[SOURCE:]FUNCTION:FM:MSIGNAL[NAME] <trace\_name>

Sending this program message sets the FM modulating signal.

[SOURCE:]FUNCTION:NOISE:SHAPE <**DNOise** | ANOise | COMB | SPANoise | SPComb>

Sending this program message selects the noise function. The following noise functions are available:

- **DNOise**       Selects digital noise. Default noise function.
- **ANOise**       Selects analog noise.
- **COMB**         Selects the comb function.
- **SPANoise**     Selects the signal plus noise function.
- **SPComb**      Selects the signal plus comb function.



---

[SOURCE:]FUNCTION:NOISE:SLENGth <integer\_numeric\_value>

Sending this program message sets the sequence length for the analog and digital noise, and signal pulse noise functions. The following sequence lengths can be entered:

63 (Default value),  
127, 255,  
511, 1023,  
2047, 4095,  
8191, 16383  
32767, 65535  
131071 (option 002 only)

[SOURCE:]FUNCTION:NOISE:NTEeth <numeric\_value>

Sending this program message sets the number of "teeth" for the comb frequency count for the Comb function. The value is between 3 and 256 with 100 being the default.

[SOURCE:]FUNCTION:NOISE:FREQuency:START  
<real\_numeric\_value>

Sending this program message sets the start frequency for the noise band for the analog noise, signal plus noise function, and signal plus comb function. The start frequency can be programmed between 0.0 Hz and 10 MHz with 1 MHz as the default frequency.

[SOURCE:]FUNCTION:NOISE:FREQuency:STOP  
<real\_numeric\_value>

Sending this program message sets the stop frequency for the noise band for the analog noise, signal plus noise function, and signal plus comb function. The stop frequency can be programmed between 0.0 Hz and 10 MHz with 2 MHz as the default frequency.

[SOURCE:]FUNCTION:NOISE:SIGNAL:NAME <shape\_name>

Sending this program message selects the signal waveform for the signal plus noise function, and signal plus comb function.

The following function shapes are available:

- DC An unvarying signal with respect to time.
- NHSine Negative haversine.
- NRAMp Negative ramp.
- PHSine Positive haversine.
- PRAMp Positive ramp.
- PRNoise Periodic random noise.
- SINC (SIN X)/X
- **SINusoid** A sinusoidal signal.
- SQUare A square wave signal.
- TRIangle A triangle wave signal.
- Trace Name Enter the name of any Arb waveform.

---

[SOURce:]FUNCTION:NOISE:SIGNAL:FREQUENCY  
<real\_numeric\_value>

Sending this program message allows the programming of the signal frequency for the signal plus noise function and the signal plus comb function. The frequency can be entered as a real number between 10 mHz and 10 MHz with 1 kHz

[SOURce:]FUNCTION:NOISE:SIGNAL:RATIO  
<integer\_numeric\_value>

Sending this program message allows the programming of the noise to signal ratio (n/s) for the signal plus noise function and signal plus comb function. The noise to signal ratio can be programmed between 1 (1% n/s) to 99 (99% n/s), the default is 25 (25% n/s).

[SOURce:]FUNCTION[:SHAPE] <source\_shape>

Sending this program message selects the shape of the output signal.

The following function shapes are available:

ANoise	Selects the currently defined analog noise; see [:SOURce]:NOISE ... .
DC	An unvarying signal with respect to time.
COMB	Selects the currently defined comb function; see [:SOURce]:NOISE ...
DNOise	Selects the currently defined digital noise; see [:SOURce]:NOISE ....
NHSine	Negative haversine.
NRAMP	Negative ramp.
PHSine	Positive haversine.
PRAMP	Positive ramp.
PRNoise	Periodic random noise.
PULSE	Selects the currently defined pulse waveform; see [:SOURce]:PULSE ... .
PTRAIN	Selects the currently defined pulse train; see [:SOURce]:PTRAIN ... .
SEQUENCE	Select the currently defined sequence; see [:SOURce]:SEQUENCE ... .
SPANoise	Selects the currently defined signal plus noise; see [:SOURce]:NOISE ...
SPComb	Selects the currently defined signal plus comb function; see [:SOURce]:NOISE ....
SINC	(SIN X)/X
<b>SINusoid</b>	A sinusoidal signal.
SQUare	A square wave signal.
TRIangle	A triangle wave signal.
USER	Selects the user defined function specified by the SOURce:FUNCTION:USER program message. Selecting a user function automatically switches the method of waveform generation to raster scan.
<trace_name>	Select the user defined function with the specified name.

[SOURce:]FUNCTION:PTRAIN:BASELINE <real\_numeric\_value>

This program message sets the baseline value for the entire pulse train. Program the baseline value between -5.0 V and 5.0 V with 5.0 being the default baseline.

---

[SOURCE:]FUNCTION:PTRAIN:COUNT <integer\_numeric\_value>  
Sending this program message defines the number of pulses in the train. Count can be programmed between 1 and 10 with a default of 2 pulses.

[SOURCE:]FUNCTION:PTRAIN:PERIOD <real\_numeric\_value>  
Sending this program message programs the period of the pulse train. Program the pulse train period between 100 ns and 655000 sec. with a default period of 300  $\mu$ s.

[SOURCE:]FUNCTION:PTRAIN:LEVEL <real\_numeric\_value>,  
<integer\_numeric\_value>  
Sending this programming message selects a pulse in the train and sets the level for that pulse. Set the level, first value, between -5.0 V and 5.0 V (5.0 V default), and select the pulse, second value, by programming an integer between 0 and 9 (default 0); 0 identifies the first pulse.

[SOURCE:]FUNCTION:PTRAIN:DELAY <real\_numeric\_value>,  
<integer\_numeric\_value>  
Sending this programming message selects a pulse in the train and sets the delay of that pulse relative to the Sync Out signal. Set the delay, first value, from -654345 sec. to 654345 sec. (0.0 default), and select the pulse, second value, by programming an integer between 0 and 9 (default 0); 0 identifies the first pulse.

[SOURCE:]FUNCTION:PTRAIN:WIDTH <real\_numeric\_value>,  
<integer\_numeric\_value>  
This program message selects a pulse in the train and sets the width of that pulse. Set the width, first value, between 10 ns and 654345 sec. (1  $\mu$ s default), and select the pulse, second value, by programming an integer between 0 and 9 (default 0); 0 identifies the first pulse.

[SOURCE:]FUNCTION:PTRAIN:TRANSITION[:STATE] <Boolean>  
Send this program message to use the fixed leading and trailing edge values (8 ns) (off or 0), or variable leading and trailing edges (on or 1).

[SOURCE:]FUNCTION:PTRAIN:TRANSITION:LEADING  
<real\_numeric\_value> , <integer\_numeric\_value>  
Send this program message to select a pulse in the train and program the leading edge of the pulse. Set the leading edge, first value, between 50 ns and 654345 sec (100 ns is the default), and select the pulse, second value, by programming an integer between 0 and 9 (default 0); 0 identifies the first pulse.

[SOURCE:]FUNCTION:PTRAIN:TRANSITION:TRAILING  
<real\_numeric\_value> , <integer\_numeric\_value>  
Send this program message to select a pulse in the train and program the trailing edge of the pulse. Set the trailing edge, first value, between 50 ns and 654345 sec (100 ns is the default), and select the pulse, second value, by programming an integer between 0 and 9 (default 0); 0 identifies the first pulse.

[SOURCE:]FUNCTION:USER <trace\_name>  
Sending this program message selects one of the user functions defined under the TRACe subsystem. The user function will be output only if USER is selected by the [SOURCE:]FUNCTION[:SHAPE] program message.

---

## **[SOURCE:]MARKer**

[SOURCE:]MARKer:POSition:AOff <trace\_name>

Sending this program message sets all POSITION marker bits to the inactive state. There is no query form for this program message.

[SOURCE:]MARKer:POSition:POINt <trace\_name>,<point\_index>

Sending this program message sets the POSITION marker at the specified point within the specified trace to the active state. There is no query form for this program message. "Point index" is an integer value.

[SOURCE:]MARKer:POSition:FREQuency <numeric\_value>

Sending this program message sets the marker frequency. Values can be entered between 1e-3 and 2e7. The default marker frequency is 1e3.

## **[SOURCE:]PULSe**

[SOURCE:]PULSe:PERiod <real\_numeric\_value>

Sending this program message programs the pulse period (pulse repetition rate). The period can be programmed between 100 ns and 655000 sec. with 300  $\mu$ s default.

[SOURCE:]PULSe:DELAy <real\_numeric\_value>

Send this program message to set the pulse delay relative to the Sync Out signal. The absolute programmable delay is -6544345 to 6544345 seconds (0.0 default). Actual delay depends on the programmed pulse period.

[SOURCE:]PULSe:WIDTh <real\_numeric\_value>

Sending this program message programs the width of the pulse at the 50% point. Pulse width is programmable between 10 ns and 654345 sec. Default equals 1  $\mu$ s.

[SOURCE:]PULSe:TRANSition[:STATe] <Boolean>

Send this program message to use the fixed leading and trailing edge values (8 ns) (off or 0) or variable leading and trailing edges (on or 1).

[SOURCE:]PULSe:TRANSition:LEADing <real\_numeric\_value>

Send this program message to program the leading edge of the pulse between 50 ns and 654345 sec (100 ns is the default).

[SOURCE:]PULSe:TRANSition:TRAILing <real\_numeric\_value>

Send this program message to program the trailing edge of the pulse between 50 ns and 654345 sec (100 ns is the default).

---

## [SOURCE:]SEQUENCE

[SOURCE:]SEQUENCE:ADVANCE <AUTO|TRIGGERED>, <INDEX>

Sending this program message selects the conditions that causes a sequence to advance to the next waveform segment.

- |           |  |
|-----------|--|
| AUTO      | Automatically advances to the next segment in the sequence after the repeat count.                       |
| TRIGGERED | Waits for a trigger "event" after the repeat count before advancing to the next segment in the sequence. |

[SOURCE:]SEQUENCE:FUNCTION <trace\_name>, <INDEX>

Sending this program message defines a list of user-defined waveforms which are to be sequenced through when the function is set to SEQUENCE. The "index" value sequentially points to each waveform segment in the sequence, from 0 up to a maximum of 3. "0" is the first segment.

[SOURCE:]SEQUENCE:DWELL <numeric\_value> (1), <INDEX>

Sending this program message defines the number of times to repeat each one of the waveform segments in the sequence. There is a one-to-one correspondence between waveform segments in the function list and repeat counts in the dwell list. The 'MINimum' and 'DEFault' values are 1, and the 'MAXimum' value is 65,535. "Index" is the segment index, ranging from 0 to 3, with "0" being the first segment. Sending a dwell of "0" continuously repeats the waveform segment.

[SOURCE:]SEQUENCE:LENGTH <numeric\_value> (2)

Sending this program message defines the number of waveform segments the sequence and the maximum "index" value for the other Sequence commands. The 'MINimum' and 'DEFault' values are 2 and the 'MAXimum' value is 4.

[SOURCE:]SEQUENCE:TRIGGER:SENSE <EDGE | LEVEL>

Sending this program message defines the active portion of the trigger signal. The trigger "event" advances the sequence from one waveform segment to the next if the ADVANCE condition is set to TRIGGERED.

- |       |  |
|-------|--|
| EDGE  | The rising edge of the trigger signal initiates the trigger event.   |
| LEVEL | The trigger event is true as long as the trigger level is held true. |

[SOURCE:]SEQUENCE:TRIGGER:MODE <SYNCHRONOUS | ASYNCHRONOUS>

Sending this program message defines the transition mode from the current waveform segment to the next waveform segment in the sequence after receiving a trigger "event". Valid if the ADVANCE condition is set to TRIGGERED.

- **SYNCHRONOUS** Wait until the end point of the current waveform segment before selecting the next segment in the sequence.
- **ASYNCHRONOUS** Immediately selects the next waveform segment in the sequence.

[SOURCE:]SUM <Boolean>

Sending this command enables or disables the Model 395's SUM IN connector. Sending 1 or ON enables the connector, and sending 0 or OFF disables the connector. OFF is the default. Use the commands "OUTPUT:ATTENUATION:MODE" and "OUTPUT:ATTENUATION[:SELECT]" to set up Summing.

---

## [SOURCE:]SWEep

[SOURCE:]SWEep:COUNT <numeric\_value> (1)

Sending this program message determines the number of sweeps which are enabled by a single trigger event. The SWEep MODE must be non-continuous. 'MINimum' and 'DEFault' values are 1, 'MAXimum' value is 1,000,000.

[SOURCE:]SWEep:DIRection <UP | DOWN>

Sending this program message controls the sweep direction. If UP is selected the sweep is performed in ascending order from START to STOP. If DOWN is selected the output frequency is swept from STOP to START.

[SOURCE:]SWEep:MODE <CRESet | TRESet | HRESet |  
CREVerse | TREVerse | HREVerse | MANual>

Sending this program message sets the mode of the sweep. The sweep modes have the following characteristics:

- **CRESet** Sweeps from the start frequency to the stop frequency and then returns to the start frequency in a continuous loop.
- **TRESet** Waits for a trigger and then sweeps from the start frequency to the stop frequency and then resets to the start frequency.
- **HRESet** Waits for a trigger and then sweeps from the start frequency to the stop frequency and then waits for another trigger before returning to the start frequency.
- **CREVerse** Sweeps from the start frequency to the stop frequency and then sweeps back to the start frequency in a continuous loop.
- **TREVerse** Waits for a trigger and then sweeps from the start frequency to the stop frequency and then sweeps back to the start frequency.
- **HREVerse** Waits for a trigger and then sweeps from the start frequency to the stop frequency and then waits for another trigger before sweeping back to the start frequency.
- **MANual** Uses the frequency set by the [SOURCE:]FREQuency:MANual program message if it is within the range of frequencies set by the [SOURCE:]FREQuency:STARt and [SOURCE:]FREQuency:STOP program messages.

[SOURCE:]SWEep:TIME <numeric\_value> (1.0)

Sending this program message sets the duration of the sweep in seconds. The sweep time may range from 30 ms to 1000 sec.

[SOURCE:]SWEep:SPACing <LINear | LOGarithmic>

Sending this program message determines the frequency verses time characteristics of the sweep.

**LINear** Output frequency is swept linearly between the STARt and STOP frequencies.

**LOGarithmic** Output frequency is swept on a logarithmic curve fitted between the STARt and STOP frequencies. The objective of the logarithmic sweep is to spend equal amounts of time within each decade of frequency.

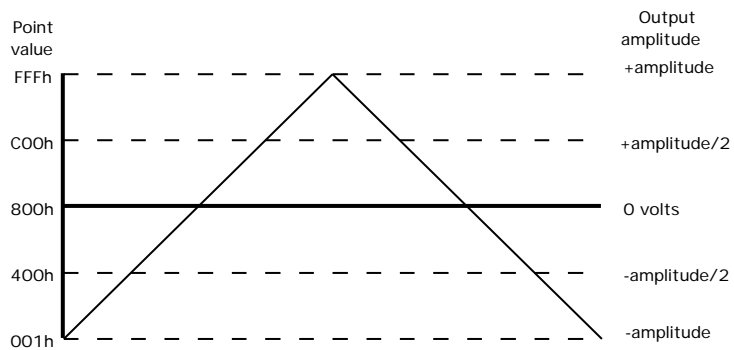
## [SOURce:]VOLTage

```
[SOURce:]VOLTage[:LEVel][:IMMediate]:OFFSet  
<numeric_value> (0.0)
```

Sending this program message controls the level of the output offset voltage. 'MINimum' offset is -5.0 Vdc, 'MAXimum' offset is +5.0 Vdc.

```
[SOURce:]VOLTage[:LEVel][:IMMediate]:AMPLitude  
<numeric_value> (1.0)
```

Sending this program message sets the absolute value of the maximum amplitude voltage. The amplitude voltage is at maximum when the selected trace point is at its minimum or maximum value. The value of a point in trace memory affects the output amplitude in the manner shown in the diagram below.



Each point in Trace Memory contains a value in the range 000h (0) to FFFh (4095). As Trace Memory is scanned these values are converted to analog voltages for output. The Arb is calibrated so the value 800h corresponds to 0 volts amplitude and the values 001h and FFFh corresponds to the negative and positive full scale amplitude voltages.

The point value 000h will generate an output voltage slightly more negative than the programmed amplitude. Limit your point values to the range 001h to FFFh if you want trace amplitudes to be symmetrical about 0 volts.

All internally generated traces of a cyclical nature (SINusoid, SQUare, TRIangle, ... etc.) are generated such that their most negative point has a value of 001h and their most positive point has a value of FFFh. This makes their amplitude voltages symmetrical about 0 volts and the absolute value of their peak voltages equal to the programmed amplitude. The 'MINimum' amplitude is 0.0 Vp, the 'MAXimum' amplitude is 5.0Vp.

```
[SOURce:]VOLTage[:LEVel][:IMMediate]:HIGH  
<numeric_value> (1.0)
```

Sending this program message sets the level of positive peak for the selected waveform. Minimum level is -5.0 V, and maximum is 5.0 V.

```
[SOURce:]VOLTage[:LEVel][:IMMediate]:LOW  
<numeric_value> (-1.0)
```

Sending this program message sets the level of negative peak for the selected waveform. Minimum level is -5.0 V, and maximum is 5.0 V.

---

## 5.6.9 STATus

STATus

```
:OPERation
  :CONDition?
  :ENABle <NRf>
  [ :EVENT]?
:QUESTionable
  :CONDition?
  :ENABle <NRf>
  [ :EVENT]?
:PRESet
```

STATus:OPERation:CONDition?

Returns the contents of the Operation Condition Register. The Model 395 supports this query, but will only return the value “0”, indicating operational condition.

STATus:OPERation:ENABle <NRf>

Sets the enable mask of the Operation Event Register, which allows true conditions to be reported in the summary bit. The Model 395 supports the command by saving the mask value and by not generating an error, although the Status registers do not exist.

The <NRf> notation indicates that SCPI’s <numeric\_value> format is not used in this case. Refer to the IEE488.2 <DECIMAL NUMERIC PROGRAM DATA>, flexible Numeric Representation for more information.

The “STATus:OPERation:ENABle?” query returns the enable mask of the Operation Event Register. The Model 395 returns the value sent previously with the command above using the <NR1> format.

STATus:OPERation[ :EVENT? ]

Returns the contents of the Operation Event Register. The Model 395 supports this query, but will only return the value “0”, indicating operational condition.

STATus:PRESet

Sets the enable registers to all 1s. The Model 395 accepts the command without performing any action.

STATus:QUESTionable:CONDition?

Returns the contents of the Questionable Condition Register. The Model 395 supports this query, but will only return the value “0”, indicating operational condition.

STATus:QUESTionable:ENABle <NRf>

Sets the enable mask of the Questionable Event Register, which allows true conditions to be reported in the summary bit. The Model 395 supports the command by saving the mask value and by not generating an error, although the Status registers do not exist.

The <NRf> notation indicates that SCPI’s <numeric\_value> format is not used in this case. Refer to IEE488.2 <DECIMAL NUMERIC PROGRAM DATA>, flexible Numeric Representation for more information.

The “STATus:QUESTionable:ENABle ?” query returns the enable mask of the Questionable Event Register. The Model 395 returns the value sent previously with the command above using the <NR1> format.

STATus:QUESTionable[ :EVENT? ]

Returns the contents of the Questionable Event Register. The Model 395 supports this query, but will only return the value “0”, indicating operational condition.



---

## 5.6.10 SYSTem

SYSTem

:CHECksum?

:ERRor?

:VERSion?

SYSTem:CHECksum?

Sending this query returns the checksum of the ROM on the CPU card. The checksum is computed by summing the values of every byte into a 16-bit value. The Model 395 returns the checksum as a four character hexadecimal value.

SYSTem:ERRor?

Sending this query returns the next message from the system error queue.

SYSTem:VERSion?

Sending this query returns the version of the firmware in the unit.

## 5.6.11 TEST

TEST>

[ :ALL ]?

:RAM?

TEST[ :ALL ]?

Sending this query performs a test on the Channel hardware. A result of zero is returned if the test passed. A nonzero result is returned if the test failed. Interpretation of the result code will indicate the nature of the error. The format of the 16-bit result code is shown below:

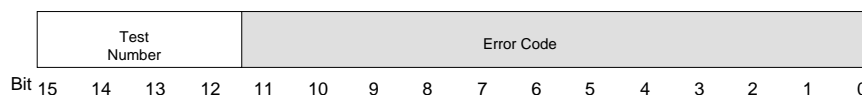


### TEST[:ALL?] Response Format

The upper 8-bits of the result code contain the sub-test number in which a failure was detected. The lower 8-bits contain a bit-weighted error code that indicates the exact cause of the failure.

TEST:RAM?

Sending this query performs a destructive test of the Trace RAM. A result of zero is returned if the test passed. A nonzero result is returned if the test failed. Interpretation of the 16-bit result code will indicate the nature of the error. Bits 15 and 14 encode the sub-test number on which the first failure was detected. The interpretation of the rest of the bits in the response depends on the sub-test.



### Trace Memory Test Response Format

---

## 5.6.12 TRACe

TRACe

```
:CATalog?
[:DATA] <trace_name>,(<block> | <trace_name>)
      :LINE<trace_name>,<point_index1>,<point_value1>,<point_index2>,<point_value2>
      :POINT <trace_name>,<point_index>,<point_value>
:DEFine <trace_name>,(<numeric_value> | <trace_name>)
:DELeTe
      [:NAME] <trace_name>
      :ALL
:DIRectory?
:FRee? <points_available>,<points_in_in_use>
:LIMits <trace_name>,<start_index>,<stop_index>
:MODE <CW | RASter>
:POINts <trace_name>,<numeric_value>
:REName <trace_name>,<trace_name>
:SELeCt <trace_name>
```

TRACe:CATalog?

Sending this query returns a string containing the names of all defined traces. Trace names are separated by commas.

TRACe[:DATA] <trace\_name>,(<block> | <trace\_name>)

Sending this program message initializes the contents of the trace whose name is specified by the first parameter. The second parameter may be binary data in Definite Length Arbitrary Block Data\*\* format, the name of a Standard Function, or the name of another trace. This program message only operates on the portion of the trace set by the trace limits. If the second parameter is a trace or Function name, that function is mapped to fill the first parameter trace name. If the second parameter is a trace and it has more points than the destination trace, points are discarded during the copy in a fashion that preserves the wave shape as much as possible.

TRACe[:DATA]? <trace\_name>

Sending this query returns the contents of the trace whose name is specified by the first parameter in Definite Length Arbitrary Block Data\*\* format. Only the data contained in the portion of the trace set by the trace limits is returned.

**\*\* See “High Speed Binary Data Transfer” at the end of this Section for more information on the Definite Length Arbitrary Block Data format.**

TRACe[:DATA]:LINE <trace\_name>,<point\_index1>,<point\_value1>,<point\_index2>,<point\_value2>

Sending this program message draws a line segment within the boundaries of the trace whose name is specified by <trace\_name>. <point\_index1> is the integer index of the start point and <point\_value1> is its decimal value. <point\_index2> is the index of the end point and <point\_value2> is its value. A line is drawn connecting the start point and end point. The first point index in a trace is zero. Point values can range from 0 to 4095.

---

TRACe:DATA:POINT <trace\_name>, <point\_index>,  
<point\_value>

Sending this program message sets the point specified by <point\_index> in the trace specified by <trace\_name> to the value specified by <point\_value>. The point index is an integer ranging from 0 (the first point) to the trace size minus one. The point value is an integer ranging from 0 to 4095.

TRACe:DATA:POINT? <trace\_name>, <point\_index>

Sending this query returns the value of the point specified by <point\_index> in the trace specified by <trace\_name>. The point index is an integer ranging from 0 (the first point) to the trace size minus one. The point value is an integer ranging from 0 to 4095.

TRACe:DEFine <trace\_name>,  
( <numeric\_value> | <trace\_name> )

Sending this program message creates a new trace with the name specified by the first parameter. The second parameter may be a numeric value indicating the size of the new trace or the name of another trace. If the second parameter is the name of a trace, the new trace is created as an exact duplicate (except for its name) of the specified trace.

TRACe:DELeTe[ :NAME ] <trace\_name>

Sending this program message deletes the specified trace.

TRACe:DELeTe:ALL

Sending this program message deletes all traces.

TRACe:DIRectory?

Sending this query returns a string containing the names, sizes and limits of all defined traces. The format of the response is as shown:

```
name1,size1, start1, stop1;name2,size2, start2,  
stop2; ... , stopn
```

TRACe:FReE?

Sending this query returns the number of trace memory points in use and the number of trace memory points available. The format of the response is as shown below:

```
<points_available>,<points_in_use>
```

TRACe:LIMits <trace\_name>, <start\_index>,<stop\_index>

Sending this program message sets the playback limits of the trace whose name is specified by <trace\_name>. The second parameter is the index of the start point and the third parameter is the index of the end point. The value of the end point must be greater than the value of the start point plus eight. Both points must be within the trace boundaries. Trace boundaries range from 0 to size -1.

TRACe:LIMits? <trace\_name>

Sending this query returns the playback limits of the trace whose name is specified by <trace\_name> in the following format:

```
<start_index>,<stop_index>
```

TRACe>:MODE <CW | RASter>

Sending this program message sets the trace playback mode. If CW is selected, a fixed 50 MHz scan rate is used and phase accumulation is used for frequency control. Frequency is controlled using the :FREQuency[:CW] program message. CW stands for Continuous Wave and implies the signal being played back is phase continuous like a sine wave. CW mode is useful primarily for playing back standard functions like sinusoid, triangle and square. Because of the fixed scan rate the 20 MHz filter can be turned on to remove the 50 MHz sampling noise and thus generate spectrally pure functions.

---

If RASter is selected the scan rate can be adjusted by the selected reference oscillator. The raster scan frequency is controlled by the :FREQUency:RASter program message. Raster mode would be used to play back arbitrary waveforms which typically define a complex pattern of amplitude versus time. The user may not want to use the filter in this mode because they may be generating stair step or pulse patterns that are meant to have sharp edges.

TRACe:POINts <trace\_name>, <numeric\_value>

Sending this program message resizes the trace whose name is specified by <trace\_name>. The new size is specified by the second integer parameter.

TRACe:POINts? <trace\_name>

Sending this query returns the size of the specified trace.

TRACe:REName <trace\_name> <trace\_name>

Sending this program message allows you to rename a trace. The first trace name identifies the existing trace, and the second trace name is the new name.

TRACe:SElect <trace name>

Sending this program message selects one of the defined traces stored in memory.

## 5.5.12 TRIGger

TRIGger

[ :SEquence]

:COUNt <numeric\_value>

:GATE

[ :STATe] <Boolean>

[ :IMMediate]

[ :ONCe]

:STATe <Boolean>

:LEVel <numeric\_value>

:POLarity <POSitive | NEGative>

:SOURce

[ :START] <INTERNAL | EXTERNAL | MANUAL>

:TIMer <numeric\_value>

TRIGger:COUNt <numeric\_value> (1)

This program message sets the number of times to cycle through a trace after a trigger is received. The COUNt value ranges from 1 to 1,048,575 for waveforms.

TRIGger:GATE[ :STATe] <ON | OFF>

This program message to enable the gate mode. Gate the Model 395 using TRIG:IMM, \*TRG, or external trigger source.

TRIGger[ :IMMediate]

This program message triggers the instrument, independently of which trigger source was selected. If the TRIG:GATE ON is selected, this command will gate the unit.

TRIGger[ :IMMediate]:STATe <Boolean>

This program message gates on and gates off the unit. Sending 1 or ON enables the generator while 0 or OFF (the default) disables the generator.

TRIGger:POLarity <POSitive | NEGative>

This program message selects the active trigger level.

---

TRIGger:SOURCE[:START] <INTernal | EXTernal | MANual>

Sending this program message selects the source of the start trigger signal. The start trigger signal initiates activity when the instrument is in a triggered mode of operation.

EXTernal

Selects an external signal jack as the trigger source.

**INTernal**

Selects an instrument dependent internal signal as the trigger source.

MANual

Selects the MAN TRIG key as the trigger source.

TRIGger:TIMer <numeric\_value> (**1e-3**)

Sending this program message sets the period of an internal periodic signal source. The timer signal acts as a trigger when it is the selected trigger source. It ranges from 2e-7 to 1e4 seconds with 2e-7 resolution.

---

## 5.7 IEEE 488.2 COMMON COMMANDS

### \*CLS

The Clear Status command clears status data structures and forces the device to the Operation Complete Keyword Idle state.

### \*ESE <value>

The Standard Events Status Enable command sets the Standard Events Register bit. The numeric value is entered as a decimal value between 0 and 255.

### \*ESE?

The Standard Events Status Enable Status query allows you to read the current contents of the Standard Event Status Enable Register. The device returns a value between 0 and 255.

### \*ESR?

The Standard Event Status Register query allows you to read the current contents of the Standard Event Status Register. Reading this register clears it.

### \*IDN?

The Identification query returns the following information: Manufacturer, Model, Serial number, and Firmware level.

### \*OPC

The Operation Complete command causes the device to generate the operation complete message in the Standard Event Status Register when all pending select device operations have been finished.

### \*OPC?

The Operation Complete query places an ASCII character 1 into the device's Output Queue after finishing all pending selected device operations.

### \*RCL<value>

The Recall command causes the instrument setup state to go to the setup last stored with \*SAV <value> or with MMEM:STOR:SET <value>, where <value> is the Stored Setting number from 0 to 32,767. The file name used is "Snnnnn", where "nnnnn" is the 5-digit string corresponding to <value>.

### \*RST

Places the instrument in its power-on-reset state. All outputs are turned off and all parameters are returned to their default values. This command does not affect the TRACe subsystem.

### \*SAV <value>

The Save command stores the current instrument setup state as a Stored Setting, where <value> is the Stored Setting number from 0 to 32,767. This setup can be restored to the instrument with the \*RCL <value> or with MMEM:LOAD:SET <"Snnnnn">. The file name created is "Snnnnn", where "nnnnn" is the 5-digit string corresponding to <value>.

### \*SRE <value>

The Service Request Enable command sets the Service Request Enable Register bits. The numeric value is entered as a decimal value between 0 and 255. The integer value is expressed in base 2 (binary). Bit 6 indicates an enabled condition.

### \*SRE?

The Service Request Enable query allows you to read the current contents of the Service Request Enable Register. The device returns a value between 0 and 63 or 128 and 191.

\*STB?

The Read Status Byte query allows you to read the status byte and Master Summary Status bit. The device returns a numeric value between 0 and 255.

\*TRG

If the instrument is in a TRIGgered mode of operation and the trigger source is set to external or manual.

\*WAI

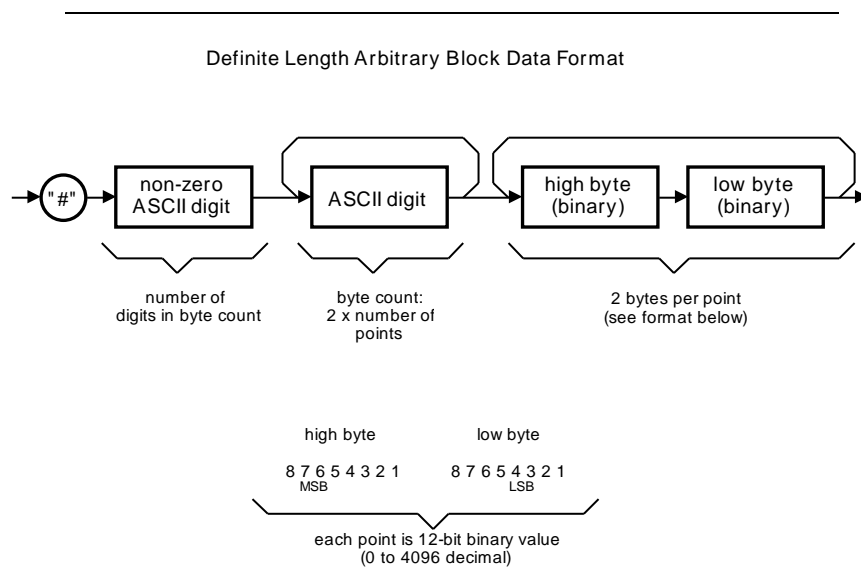
The Wait-to-Continue command prevents the device from executing any further commands or queries until the No-Operation-Pending flag is TRUE.

## 5.8 HIGH SPEED BINARY WAVEFORM TRANSFER

The High Speed Binary Waveform Transfer operates with the GPIB interface. Do not attempt a <block> transfer using the TRACe[:DATA] commands when using the RS-232-C interface unless hardware handshaking is enabled. Otherwise, this will result in unpredictable behavior from the Model 395.

Use the SCPI command TRACe[:DATA] <trace\_name>,<block> to download user-defined Waveforms from the remote controller to the ARB. Likewise, use the query form, TRACe[:DATA]? <trace\_name>, to upload the waveform data back up to the controller.

In both of these cases, the data block is transferred using the IEEE-488.2 Definite Length Arbitrary Block Data format (see the figure below). This format for block data transfer makes it possible to rapidly move the large amount of data required for arbitrary waveforms.



To send a block of waveform data, send an ASCII “#” (\$23), then an ASCII encoded digit whose value signifies the number of digits in the byte count, then ASCII encoded digit(s) representing the byte count, then the two byte binary data words (MSB first).

---

The byte count is twice the number of points to be downloaded to the trace. The byte count must exactly correspond to the number of bytes in the block of data. Each data word is a two byte word representing a 12-bit binary unsigned integer between 0 and 4095.

Prior to downloading a Waveform using the TRACe[:DATA] <trace\_name>,<block> command, the Trace must be first reserved in the channel memory.

As an example, the command:

```
TRACe:DATA wave1, #3800
```

would begin the transfer of 800 bytes of data (400 points) to the Model 395, trace "wave1." Exactly 800 bytes of data must directly follow.

Send the TRACe:DEFine <trace\_name>,<value> command to reserve trace memory of <value> points under the <trace\_name>. This also presets the Trace Limits for this trace at full size. You may select a segment of this trace for download (or subsequently, for upload) using the TRACe:LIMits <trace\_name>,<start\_index>,<stop\_index> command.

#### **NOTE**

When the block size exceeds the capability of your download or upload application, you may use the TRACe:LIMits feature to break the block up into manageable segments.

The "binary" transfer using this format occurs at a relatively high speed because the binary data is not parsed through the Command Processor. Instead, the binary data is routed directly to channel memory without processing or limit checking, much like a direct memory access (DMA).

If the waveform limits (size), the byte count or the number of bytes in the <block> are not all in numeric agreement, or one half second elapses without receiving any data, the high speed transfer will be aborted.

Any data received after this will be interpreted by the Command Processor as ASCII characters and may cause the Model 395 to act unpredictably. Because of this low tolerance for errors, the high speed waveform transfer method should be used with extreme care.



---

## 5.9 RS-232-C PROGRAMMING

Section 2 describes the model 395 installation and interconnections for RS-232-C. Be sure that you have the baud rate set correctly at the Model 395 and at the DTE.

## 5.10 GPIB ERROR HANDLING AND STATUS REPORTING

Errors and status in the 395 are handled as described for Device Status Reporting consistent with the IEEE-488.2 standard in Chapter 11. Errors and status may be monitored by reading the IEEE-488.1 Status Register, either by serial polling the 395 or by sending a Status Byte read command (\*STB?) to the 395. Each module has its own Status Byte associated with its own secondary address. The serial poll or the \*STB? query have to be done to the primary and secondary address of the module.

Three bits in the Status Byte are defined as follows:

### Bit 6 (DI07): RQS/MSS

RQS/MSS acts as a summary bit for the rest of the Status Byte bits. If any of the other Status Byte bits are asserted along with their corresponding mask bits in the Service Request Enable Register, then the RQS/MSS bit will be asserted. This allows the controller to test for the RQS/MSS bit for selected information (selected by the mask bits in the Service Request Enable Register) automatically without having to mask and test the Status Byte manually.

RQS is in response to a serial poll and is partially defined in the IEEE-488.1 specification and further defined in the IEEE-488.2 specifications. RQS will be true during a serial poll if the 395 has an SRQ true condition pending.

MSS is in response to a \*STB? query and is defined in the IEEE-488.2 specifications. MSS will be true if the logical AND of the Status Byte bits and a mask byte, the Service Request Enable Register yields a true result in any bit location (except bit 6 of course). The only bits used in the 395 are bit 4 (DI05) and bit 5 (DI06) mentioned below.

### Bit 5 (DI06): ESB

Standard Event Status Bit Summary Message. This is a summary message bit for the Standard Event Status Register, see "Bit 4 (DI05): MAV."

### Bit 4 (DI05): MAV

Message Available Queue Summary Bit. This bit is always true if another byte is available to be output to the controller. When the queue is empty, the MAV bit is cleared.

The remaining bits in the 395 Status Byte have no effect. The ESB bit is a summary bit for another status register, called the Standard Event Status register, which is used to extend the types of status information available to the controller from the instrument's status functions. The IEEE-488-2 document defines all eight bits for particular functions. The 395 only uses a subset of these. They are as follows:

Bit 7: Power On (not used)

Bit 6: User Request (not used)

Bit 5: Command Error

Set to true whenever a syntax error is encountered in the command string to the 395.

---

#### Bit 4: Execution Error

Set whenever a parameter exceeds the range available for that parameter, except for inter-parameter conflict errors which are handled by bit 3.

#### Bit 3: Device Dependent Error

Set whenever the instrument module encounters an error specifically associated with the operation of that type of module. This includes inter-parameter conflict errors.

#### Bit 2: Query Error

Set whenever a query is made to the 395 for which no response is available.

#### Bit 1: Request Control (not used)

#### Bit 0: Operation Complete

Set whenever the last command has finished execution and the Model 395 is ready to accept another command or the results from the last query are available.

This register, along with a mask enable register called the Standard Event Status Enable Register, is used to set the ESB bit in the Status Byte of the Model 395 GPIB interface. The Standard Event Status Register (ESR) is bit-wise logically ANDed with the Standard Event Status Enable Register (ESE) to generate the ESB bit. If any of the bits in the ESR are true along with the corresponding bits in the mask ESE, then the Event Status Summary Bit (ESB, bit 6) in the GPIB Status Byte will be asserted. This way the Status Byte can be serial polled to see if any one of the conditions in the ESR has occurred.

Below is a list of SCPI error messages that might occur during operation. Each is listed inside quotes. For a detailed description of what each error code means, refer to the 1993 SCPI Command Reference manual, Chapter 21, "SYSTEM:ERRor?"

32767, "Invalid error number"  
0, "No error"  
-100, "Command error"  
-101, "Invalid character"  
-102, "Syntax error"  
-103, "Invalid separator"  
-104, "Data type error"  
-105, "GET not allowed"  
-108, "Parameter not allowed"  
-109, "Missing Parameter"  
-110, "Command header error"  
-111, "Header separator error"  
-112 "Program mnemonic too long"  
-113 "Undefined header"  
-114 "Header suffix out of range"  
-120 "Numeric data error"  
-121 "Invalid character in number"  
-123 "Exponent too large"  
-124 "Too many digits"  
-128 "Numeric data not allowed"  
-130 "Suffix error"

---

-131 "Invalid suffix"  
-134 "Suffix too long"  
-138 "Suffix not allowed"  
-140 "Character data error"  
-141 "Invalid character data"  
-144 "Character data too long"  
-148 "Character data not allowed"  
-150 "String data error"  
-151 "Invalid string data"  
-158 "String data not allowed"  
-160 "Block data error"  
-161 "Invalid block data"  
-168 "Block data not allowed"  
-170 "Expression error"  
-171 "Invalid expression"  
-178 "Expression data not allowed"  
-180 "Macro error"  
-181 "Invalid outside macro definition"  
-183 "Invalid inside macro definition"  
-184 "Macro parameter error"  
-200 "Execution error"  
-201 "Invalid while in local"  
-202 "Settings lost due to rtl"  
-210 "Trigger error"  
-211 "Trigger ignored"  
-212 "Arm Ignored"  
-213 "Init ignored"  
-214 "Trigger deadlock"  
-215 "Arm deadlock"  
-220 "Parameter error"  
-221 "Settings conflict"  
-222 "Data out of range"  
-223 "Too much data"  
-224 "Illegal parameter value"  
-230 "Data corrupt or stale"  
-231 "Data questionable"  
-240 "Hardware error"  
-241 "Hardware missing"  
-250 "Mass storage error"  
-251 "Missing mass storage"  
-252 "Missing media"  
-253 "Corrupt media"  
-254 "Media full"  
-255 "Directory full"  
-256 "File name not found"  
-257 "File name error"  
-258 "Media protected"  
-260 "Expression error"

---

-261	"Math error in expression"
-270	"Macro error"
-271	"Macro syntax error"
-272	"Macro execution error"
-273	"Illegal macro label"
-274	"Macro parameter error"
-275	"Macro definition too long"
-276	"Macro recursion error"
-277	"Macro redefinition not allowed",
-278	"Macro header not found"
-280	"Program error"
-281	"Cannot create program"
-282	"Illegal program name"
-283	"Illegal variable name"
-284	"Program currently running"
-285	"Program syntax error"
-286	"Program runtime error"
-300	"Device-specific error"
-310	"System error"
-311	"Memory error"
-312	"PUD memory lost"
-313	"Calibration memory lost"
-314	"Save/recall memory lost"
-315	"Configuration memory lost"
-330	"Self-test failed"
-350	"Queue overflow"
-400	"Query error"
-410	"Query INTERRUPTED"
-420	"Query UNTERMINATED"
-430	"Query DEADLOCKED"
-440	"Query UNTERMINATED after indefinite response"

This list contains error and warning messages returned by the VXIAWG.

"No error", .....	Error code 0
"Amplitude + Offset > 5.0 Volts", .....	Error code 1
"Destination trace not defined", .....	Error code 2
"Missing second argument", .....	Error code 3
"Trace name already defined", .....	Error code 4
"Defined trace size too large", .....	Error code 5
"Default trace size too large", .....	Error code 6
"Source trace not defined", .....	Error code 7
"Block larger than trace size", .....	Error code 8
"Playback length < 10 points", .....	Error code 9
"Playback length out of bounds", .....	Error code 10
"Point out of bounds", .....	Error code 11
"Sequence length > trace count", .....	Error code 12
"Traces not on 8k boundaries", .....	Error code 13
"Not enough memory for resize", .....	Error code 14

---

"First point left of second point", .....	Error code 15
"Second point out of bounds", .....	Error code 16
"Unable to access application hardware", .....	Error code 17
"Not enough memory to create function", .....	Error code 18
"Invalid function name", .....	Error code 19
"Trace start not on 4k boundary", .....	Error code 20
"Trace size not on 4k boundary", .....	Error code 21
"Bad enumerated value", .....	Error code 22
"Calibration data version invalid", .....	Error code 23
"No defined user functions", .....	Error code 24
"Unable to allocate memory for operation", .....	Error code 25
"Unable to write to EEPROM", .....	Error code 26
"Clock BNC configured as output with external clock selected", .....	Error code 27
"Stop frequency < start frequency", .....	Error code 28
"Sweep frequency out of range", .....	Error code 29
"Command supported only by slot 1", .....	Error code 30
"Frequency out of range for function", .....	Error code 31
"Unused error code", .....	Error code 32
"Self calibration data invalid", .....	Error code 33
"Manual calibration data invalid", .....	Error code 34
"Store setup error", .....	Error code 35
"Recall setup, missing waveform", .....	Error code 36
"Recall setup, incompatible version", .....	Error code 37
"Trigger gate must be on", .....	Error code 38
"Cal Enable switch must be in CAL position", .....	Error code 39
"Frequency must be 5 MHz for trigger operation", .....	Error code 40
"Cannot sweep a sequence", .....	Error code 41
"Trace size must be an even number", .....	Error code 42
"Trace start must be an even number", .....	Error code 43
"Trace stop must be an odd number", .....	Error code 44
"Deleted trace being output, Func Out is now Sine ", .....	Error code 45
"Sequence not properly defined" .....	Error code 46
"Backup RAM contents invalid, RAM has been re-initialized", .....	Error code 47
"Cannot gate a sequence", .....	Error code 48
"Start/Stop frequency ratio > 0.9", .....	Error code 49
"Signal name not defined", .....	Error code 50
"Invalid command for selected noise function", .....	Error code 51
"Noise calculations, waveform clipped", .....	Error code 52
"Signal Frequency too low", .....	Error code 53
"Signal Frequency too high", .....	Error code 54

---

"Noise calculations, waveform too large",.....	Error code 55
"Bandwidth > 10MHz",.....	Error code 56
"Function canceled", .....	Error code 57
"Noise sequence length too long for function", .....	Error code 58
"Pulse delay is too negative", .....	Error code 59
"Trigger count >524287 for sequence not allowed",..	Error code 60
"Selected attenuator causes lower amplitude and offset", .....	Error code 61
"Frequency span (carrier/ modulation) too high",....	Error code 62
"Function not allowed as signal",.....	Error code 63
"Frequency too high for AM/FM", .....	Error code 64
"Function setup error",.....	Error code 65
"Cannot use selected function as signal",.....	Error code 66
"Internal Execute Error",.....	Error code 67
"Maximum number of waveforms have been defined", .....	Error code 68

**Noise**

"Function: <NAME> not allowed as signal"

**Pulses / Pulse Trains**

"Pulse <1..10>, <delay,lead,width,trail> s/b "greater or less than"  
<limit> for this period range"

"Pulse <1..10>, width too small for lead / trail, must be >limit"

"Pulse <1..10>, delay + lead + width + trail > period"

"Pulse <1..10>, delay + lead + width + trail > period"

## 5.11 RESUMING LOCAL OPERATION

When the GPIB or RS-232-C interface has remote control of the Model 395, your front panel operator controls will function only to query, and not set, parameter values (even then, only when there is no bus activity). When you discontinue remote interface operations, you will not have local control returned to you unless the remote application has specifically sent a Go To Local (IEEE-488.1 ASCII GTL) code. If you find that you do not have local control after a remote programming session, you will have to manually return to local control. To do this, press the "Remote" key and select "go-local." This could also be accomplished by cycling power to the Model 395.

## A.1 MODEL 395

Model 395, a high-performance 100 MHz Synthesized Arbitrary Waveform Generator, functions as seven different instruments:

- Synthesized Function Generator with 19 standard waveforms.
- Arbitrary Waveform Generator which stores up to 100 user-defined waveforms.
- Trigger Generator with selectable internal or external trigger source.
- Sweep Generator with full frequency sweeping from 1 mHz to 20 MHz.
- Pulse Generator with programmable delay and width times, as well as variable rise and fall times, and pulse trains of up to 10 pulses.
- Noise Generator providing analog noise, digital noise, comb function, signal plus noise function, and signal plus comb function.
- Amplitude Modulation Source allowing internal and external Amplitude Modulation (100%) and Suppressed Carrier Modulation (200%).

Some of the important features of the Model 395:

- Sample clock up to 100 MHz.
- Complex sequencing of arbitrary waveforms.
- Sweep and Amplitude Modulation.
- Trigger and Gate modes.
- 12-bit Vertical Resolution.
- Standard Waveforms: sine, square, triangle, ramps, haversines,  $\sin(x)/x$ , noise, pulse, amplitude modulation, frequency modulation, and DC.
- Synthesized frequency accuracy with up to 10 digits of frequency resolution.
- Signal Summing (Sum In)
- RS-232 Interface standard and optional IEEE-488 Interface and Direct DSO.

---

## A.2 SPECIFICATIONS

Performance specifications apply within the specified environmental conditions after a 20 minute warm up period.

### A.2.1 Amplitude

Range:	10 mVp-p to 10 Vp-p into 50 .
Resolution:	3 digits; limited by 1 mV.
Accuracy*:	25±10°C; ±(1%+2 mVp-p). 0 to 50°C; ±(2%+4 mVp-p).

\* *Offset=0 Vdc*

#### Note

Waveform output may be inverted by programming negative amplitude value.

### A.2.2 Offset

Range:	±5.00 V into 50 .
Resolution:	3 digits.
Accuracy:	25 ±10°C; ±(1%+20 mV). 0 to 50°C; ±(2%+40 mV).

### A.2.3 Standard Waveforms

The following are standard Model 395 waveforms:

- Sine
- Square
- Triangle
- DC
- positive ramp
- negative ramp
- positive haversine
- negative haversine
- sin(x)/x
- analog (white) noise
- digital noise
- random noise
- comb function
- signal plus comb function
- signal plus noise
- pulse
- pulse train
- AM
- FM

#### A.2.3.1 Frequency (Standard Functions)

##### Sine and Haversine Waveforms

Range:	1 µHz to 40 MHz.
Resolution*:	≤20 MHz; 10 digits; >20 MHz; 4 digits.
* <i>Limited by 1 µHz</i>	
Accuracy:	≤20 MHz; ±30 ppm; >20 MHz; ±100 ppm.



---

## Square Waveform

Range:	1 mHz to 50 MHz.
Resolution:	4 digits.
Accuracy:	±100 ppm.

## Triangle Waveform

Range:	1 µHz to 10 MHz.
Resolution*:	≤100 kHz; 10 digits; >100 kHz; 4 digits.
<i>* Limited by 1 µHz</i>	
Accuracy:	≤100 kHz; ±30 ppm; >100 kHz; ±100 ppm.

## Ramp and Sin(x)/x Waveforms

Range:	1 µHz to 2 MHz (ramp) 1 µHz to 1 MHz ((sin(x)/x)).
Resolution*:	≤100 kHz; 10 digits; >100 kHz; 4 digits.
<i>* Limited by 1 µHz</i>	
Accuracy:	≤100 kHz; ±30 ppm; >100 kHz; ±100 ppm.

Note Frequency is limited to 10 MHz for gated and triggered modes.

### A.2.3.2 Waveform Quality

#### Square

Square Transition Time:	<8 ns.
Square Aberrations:	<(5% + 20 mV).

#### Sine Distortion:

100 kHz	0.15% (-56 dBc).
5 MHz	no harmonic > -35 dBc.
40 MHz	no harmonic > -22 dBc.

Frequency response of sine wave (loaded into 50 Ω).

Reference = 1 kHz	
100 kHz	±0.2 dB.
5 MHz	±0.5 dB.
20 MHz	±1.0 dB.
40 MHz	±1.5 dB.

### A.2.4 Arbitrary Waveforms

The Model 395 allows up to 100 user defined waveforms to be stored in RAM. Waveforms can be defined by front panel editing controls or by downloading of waveform data from RS232 or optional GPIB interfaces.

#### Waveform Memory Size

64K words - 256K words optional (maximum waveform size is 128K) (minimum waveform size is 10 points).

#### Vertical Resolution

12 bits

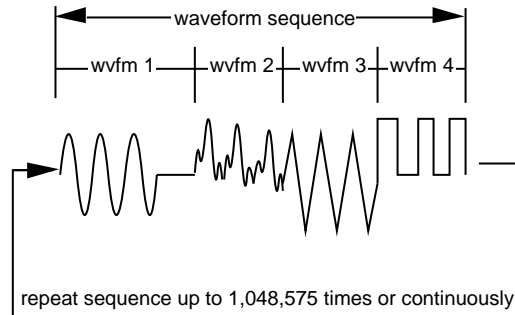
#### Sample Clock

Range:	100 mHz to 100 MHz.
Resolution:	4 digits.
Accuracy:	±100 ppm.

---

## A.2.5 Waveform Sequencing

The Model 395 provides complex waveform sequencing. Up to 4 waveforms may be linked. Each waveform can have a loop count of up to 65,535 or run continuously, conditional upon an external trigger event (loop until event true). Additionally, a sequence of waveforms can be looped up to 1,048,575 times or run continuously.



Conditions for advancing from one waveform in the sequence to the next are user selectable as completion of loop count, trigger or both.

## A.2.6 Output Filter

20 MHz Elliptic (8 pole).

40 MHz Elliptic (8 pole).

10 MHz Bessel (2 pole).

No filter.

## A.2.7 Pulse/Pulse Train

The Model 395 builds pulse patterns according to user specifications. Pulse specifications are divided into two ranges based on the minimum period of the waveform. The minimum period is defined as the minimum time required to generate one complete pulse pattern waveform. A complete pulse pattern may contain as many as 10 pulses.

### Period (<655 $\mu$ s)

Range: 100 ns to 655  $\mu$ s.

Resolution: 20 ns.

Accuracy:  $\pm 100$  ppm.

Rise/Fall Time:

Fixed: <8 ns.

Variable: 50 ns to 500  $\mu$ s.

Resolution: 8 ns.

Accuracy:  $\pm 0.1\%$  +5 ns (<8 ns for fixed rise/fall).

Delay:

Range: -600  $\mu$ s to +600  $\mu$ s.

Resolution: 10 ns.

Accuracy:  $\pm 0.1\%$   $\pm 5$  ns.

Width:

Range: 10 ns to 655  $\mu$ s.

Resolution: 10 ns.

Accuracy:  $\pm 0.1\%$   $\pm 5$  ns.

---

## Period (>655 $\mu$ s)

Range: 655  $\mu$ s to 10 seconds.

Resolution: 4 digits.

Accuracy:  $\pm$ 100 ppm.

Rise/Fall Time:

Range: 0.1% to 79% of period (or <8 ns).

Delay:

Range: -99.9% to +99.9% of period.

Width:

Range: 0.002% to 99.9% of period.

## A.2.8 Noise

The Model 395 provides five noise related functions. Applicable specifications are given for each noise function below:

### Analog (White) Noise

Provides a uniform frequency distribution. The noise bandwidth is programmable.

Noise BW Range:	10 mHz to 10 MHz.
Resolution:	3 digits.
Accuracy	typically <1%.
Sequence length	$2^{n-1}$ ; n=6,7,...16.
Option 002	$2^{n-1}$ ; n=6,7,...17.

Note Ratio of Start/Stop must be 0.8.

### Digital Noise

Digital Noise provides a random 0, 1 pattern from the main output and the sync output.

Clock Range:	10 mHz to 100 MHz.
Resolution:	4 digits.
Accuracy	100 ppm.
Sequence length	$2^{n-1}$ ; n=6,7,...16.
Option 002	$2^{n-1}$ ; n=6,7,...17.

Note Sequence length defines the number of waveform points that noise will be randomly generated.

### Comb

The comb function provides uniformly distributed frequency spectra in a well defined frequency band.

Start/Stop Range:	1 Hz to 10 MHz.
Resolution:	3 digits.
Accuracy	100 ppm.
Number of frequency teeth:	3 to 256.

Note Ratio of Start/Stop 0.8.

---

## Signal Plus Noise

The signal plus noise function allows analog noise to be added to any standard or arbitrary waveform with a precisely controlled signal to noise ratio.

N/S ratio: 1% Vp-p to 99% Vp-p.  
Resolution: 1%.

### Note 1

N/S ratio is based on peak to peak values of signal and noise not on Vrms.

### Note 2

Ratio of signal frequency to noise center frequency cannot exceed 40:1 or 1:40.

## Signal Plus Comb

The signal plus comb function allows a comb spectrum to be added to any standard or arbitrary waveform with a precisely controlled signal to comb ratio.

Comb plus signal ratio: 1% Vp-p to 99% Vp-p.  
Resolution: 1%.

### Note 1

Comb plus signal ratio is based on peak to peak values of signal and comb not on Vrms.

### Note 2

Ratio of signal frequency to comb center frequency cannot exceed 40:1 or 1:40.

## A.2.9 Internal Frequency Modulation

### Carrier Signal

Source: Sine Wave  
Center Frequency Range: 1 Hz to 40 MHz  
Deviation Frequency Range: 1 Hz to 40 MHz

**Note** Center frequency plus Deviation Frequency must be 40 MHz.

### Modulating Signal

Source: Any waveform except Noise, AM, FM, or Pulse.  
Modulation Frequency Range: 1 Hz to 40 MHz.

### Note

The ratio between Center Frequency plus Deviation Frequency and modulation frequencies must be 24,000.

## A.2.10 Internal Amplitude Modulation

### Modes

AM: 0% to 200% Modulation  
SCM: 200% Modulation

---

## Carrier

Source: Sine Wave

Carrier Frequency Range: 1 Hz to 40 MHz

## Modulating Signal

Source: Any waveform except Noise, AM, FM, or Pulse.

Modulation Frequency Range: 1 Hz to 40 MHz

Note The ratio between carrier and modulation frequencies must be  $\geq 24,000$ .

### A.2.11 Operating Modes

The Model 395 provides the following operation modes.

#### Continuous

The selected waveform is output continuously at the programmed frequency.

#### Gated

The selected waveform is output continuously at the programmed frequency while the selected trigger signal is true. When the trigger signal transitions to false, the output will complete the current waveform cycle and then hold at the beginning of the waveform until the trigger signal becomes true again.

#### Triggered

Upon transition of the selected trigger from false to true the number of waveform cycles specified by the count is output at the specified frequency. Count is programmable from 1 to 1,048,575.

#### Sweep

When selected the output frequency is swept according to programming of sweep parameters.

Note When in non-continuous modes frequency resolution is limited to 4 digits.

### A.2.12 Triggering

The Model 395 has four sources of triggers: external TRIG IN BNC, internal trigger generator, front panel manual trigger key, and “remote” GPIB or RS-232 trigger command. The manual trigger key is active whether the trigger source is set to external or internal. Remote trigger is always possible and cannot be selected or disabled.

#### External Trigger Source

##### Trigger Level

The trigger level at the TRIG IN BNC is programmable:

Range:	-10 V to +10 V
Resolution:	10 mV
Accuracy:	300 mV

##### Trigger Slope

Selectable as positive or negative at the TRIG IN BNC.

---

## Internal Trigger Source

An internal trigger source is provided with the following specifications:

Range:	200 ns to 1000 seconds.
Resolution:	100 ns limited by 6 digits.
Accuracy:	±30 ppm.

## Trigger Jitter

During Standard Waveforms:	< 20 ns.
During User Defined Waveforms:	< 40 ns.

## A.2.13 Sweep

The Model 395 provides sweep capability for standard and arbitrary waveforms. If sweep is selected for an arbitrary waveform, it will be expanded or condensed to fit into exactly 4096 points (only while sweeping; data is not lost). The internal sample rate clock is set to 50 MHz and the sweep is performed using DDS techniques.

Additionally a 20 MHz brickwall filter is automatically selected. Attempting to sweep arbitrary waveforms with spectral content beyond 20 MHz will result in distortion of the waveform. Also, position and sync markers may not function normally when sweeping at higher frequencies. This frequency is dependent upon the original size of the arbitrary waveform and is computed as:  $(50 \text{ MHz} \div \text{size})$ .

## Sweep Start/Stop

Range:	1 mHz to 20 MHz.
Resolution:	4 digits (limited by 1 mHz).
Accuracy:	30 ppm.

## Sweep Time

Range:	30 ms to 1000 seconds.
Resolution:	1 ms.
Accuracy:	0.2%.

## Sweep Types

Continuous	Continuous with reverse
Triggered	Triggered with reverse
Triggered with hold	Triggered with hold and reverse
Manual	

## Sweep Spacing

Linear  
Logarithmic

## A.2.14 Amplitude Modulation

The Model 395 provides external amplitude modulation capability for standard and arbitrary waveforms. Amplitude modulation is selectable as Normal or Suppressed Carrier.

### Normal AM

0 to 100% modulation. Amplitude is reduced to one half of the programmed value (50%) with no signal present at the AM Input. +1.25V at the AM Input will result in 100% of programmed amplitude, -1.25V will result in 0%.

### Suppressed Carrier Modulation (SCM)

±100% modulation. With no signal present at the AM Input the output amplitude will be 0 Vp-p. +2.5 V will result in 100% of the programmed amplitude. -2.5 V will result in minus 100% (full amplitude, but 180 degrees out of phase).

---

## Modulation Input Scaling

Signal present at input connector will modulate output signal as defined by selected modulation mode. Input scaling is defined as follows for each mode:

Mode	Input Level	Scale
Normal AM:	+1.25 V $\pm$ 100 mV =	100%
	-1.25 V $\pm$ 100 mV =	0%
SCM	+2.50 V $\pm$ 200 mV =	100%
	-2.50 $\pm$ 200 mV =	-100%

## Modulation Distortion

<1% at 1 kHz modulation frequency and a depth of 80%.

## Modulation Bandwidth

>100 kHz.

### A.2.15 Sync Output

The Model 395 allows the sync output to be selected from among seven sources.

#### Waveform Sync

For standard waveforms this will be an approximate 50% duty cycle waveform derived by “zero crossing” the output waveform. For arbitrary waveforms this will be a pulse with a minimum width of 40 ns. The pulse may be positioned to be coincident with any point on the arbitrary waveform and is programmed by the sync address parameter.

#### Position Marker

For arbitrary waveform a marker signal is provided, allowing any point on a waveform to have an associated marker bit set high or low.

#### Trigger Signal

This will select the current trigger signal. This is useful for synchronizing bursted or gated signals.

#### Burst Done

This will select the internal end of burst signal and will be a pulse coincident with the end of the last cycle of a burst.

#### Loop Done

This will select the internal end of sequence signal which is a pulse coincident with the completion of a link sequence.

#### Sweep Marker

Selects the frequency sweep marker signal. For use with frequency sweeps. A TTL high corresponds to an active marker.

#### Pen Lift

Selects the sync out as a pen lift signal for use with strip chart recorders. Pen is lifted whenever the sweep is idle or during the “retrace.”

---

## A.2.16 Signal Summing

External signals may be summed directly to the Model 395's output through the SUM IN BNC. The scale factor of the Sum Input is dependent upon the selected output attenuator which is dependent on the combination of amplitude and offset program. For a given setup the scale factor will be displayed via front panel or remote query (see table below). Scale factor accuracy (expressed in units of  $V_{out}/V_{in}$ ) is 5%.

Peak Ampl+ ABS(Offset)	Attenuation	MAIN OUT/SUM IN Ratio
2.500 to 5.00 V	0 dB	1 V/V
1.250 to 2.500	-6 dB	0.5 V/V
0.625 to 1.250	-12 dB	0.25 V/V
0.313 to 0.625	-18 dB	0.125 V/V
0.156 to 0.313	-24 dB	0.0625 V/V
0.078 to 0.156	-30 dB	0.03125 V/V
0.039 to 0.078	-36 dB	0.015625 V/V
0.019 to 0.039	-42 dB	0.0078125 V/V

## A.2.17 Inputs/Output

Maximum Floating Voltage w.r.t RS423 & IEEE 488  $\pm 42$  Vpk

### Trigger Input

Level:	Programmable between $\pm 10$ V.
Impedance:	2 k $\Omega$ .
Min width:	>20 ns.
Max frequency:	5 MHz.
Protection:	Overvoltage to $\pm 25$ V without damage.

### Sum Input

Level:	$\pm 5$ Vp-p maximum.
Impedance:	600 $\Omega$ .
Bandwidth	>30 MHz.
Protection:	Overvoltage to $\pm 10$ V without damage.

### Reference Input

Level:	1 Vp-p min, 10 Vp-p max; 50 Vdc maximum.
Impedance:	5 k $\Omega$ (AC coupled).
Duty cycle:	40 - 60%.
Frequency:	10 MHz $\pm 5\%$ .
Protection:	Overvoltage to $\pm 50$ V without damage.

### Reference Output

Level:	TTL level into open circuit; >1.2 Vp-p into 50 $\Omega$ .
Impedance:	50 $\Omega$ .
Frequency:	Same as selected reference (internal or external).
Protection:	Short circuit without damage.

### Main Output

Impedance:	50 $\Omega$ $\pm 1\%$ .
Protection:	short circuit without damage.
Off Isolation:	-50 dBc at 20 MHz loaded into 50 $\Omega$ .

### AM Input

Impedance:	>2.5 k $\Omega$ .
Level:	$\pm 2.5$ V.
Protection:	overvoltage to $\pm 25$ V without damage.



---

## Sweep Output

A 0 to 10 Volt ramp proportional to sweep time.

Low level:	0V $\pm$ 0.5V into open circuit.
High level:	+10V $\pm$ 0.5V into open circuit.
Impedance:	1 k $\pm$ 5%.
Protection:	short circuit or over voltage to $\pm$ 15V without damage.

## Sync Output (50 )

Low level:	<0.4 V	into 50
High level:	>2.0 V	into 50
Impedance:	>50	
Rise/fall time:	<7 ns	
Protection:	short circuit without damage	

## A.3 OPTIONS

### A.3.1 Option 001

IEEE-488 Interface and Direct DSO (digital storage oscilloscope) Waveform Transfer.

### A.3.2 Option 002

256K Extended Memory (128K maximum waveform size).

### A.3.3 Option 004

Model 395 rack mount kit.

### A.3.4 Waveform DSP2

Arbitrary Waveform Creation Software (DOS).

## A.4 GENERAL

### A.4.1 Physical

#### Dimensions

35.6 cm (14.00 in.) wide, 13.3 cm (5.22 in.) high and 39.4 cm (15.5 in.) deep.

#### Weight

Approximately 7.7 kg (17 lb.) net; 11.8 kg (26 lb.) shipping.

#### Power

90 to 132, 198 to 252 VAC RMS; 48 to 440 Hz; 1 phase; <80 VA.



This instrument must be operated with a protective ground connected via the ac supply cord. SEE THE SAFETY ISSUES SECTION AT THE FRONT OF THIS MANUAL.

---

## A.4.2 Environmental Specifications

Designed and tested to MIL-T-28800D Class 5.

### Temperature Range

Operates from 0°C to +50°C, -20°C to +70°C for storage.

### Warm-up Time

20 minutes for specified operation.

### Altitude

Operating and Non-operating 2000 m @ +40 °C.

### Humidity

IEC 68-2-Ca at +40 °C with 95 % RH. Operates over 11°C to +30°C at 95% relative humidity (non-condensing), 31°C to +40°C at 75% RH, 41°C to 50°C at 45% RH.

### Pollution

Degree 1.

### Vibration

Operates with a vibration level of 0.013 in. from 5 to 55 Hz (2 g. acceleration at 55 Hz).

### Shock

Non-operating; 40 g., 9 ms half-sine.

### Bench Handling

Operating; 4 inch or point of balance drop, any face, solid wooden surface.

## A.4.3 Electromagnetic Compatibility

Emission: EN50081-1: EN55011/22, Class A radiated and conducted emissions.

Immunity: EN50082-1: IEC 801-2 Electrostatic discharge immunity,  
IEC 801-3 RF electromagnetic field immunity,  
IEC 801-4 Electrical fast transient / burst immunity,  
IEC 801-5 Power line surge immunity.

## A.4.4 Reliability Specifications

For “ground benign” environments. QA calculation of using MIL-HDBK-217 yielded >10,000 hours at 50% component stress.

## A.4.5 Safety Specifications

Designed to comply with UL-1244, EN-61010, and MIL-T-28800D.

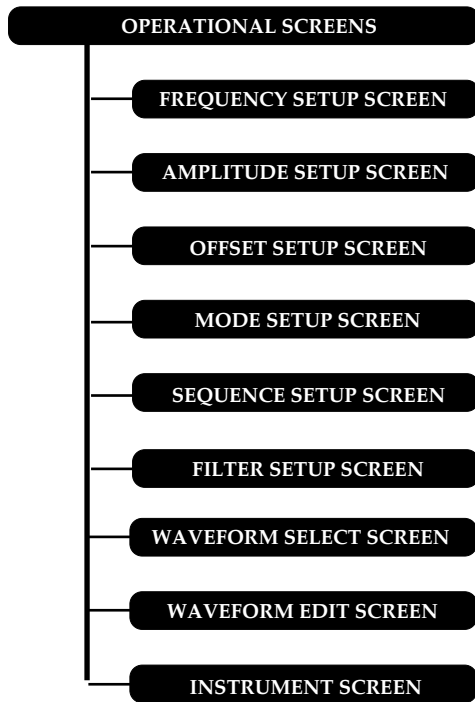
## A.4.6 Calibration Interval

The Calibration Interval shall be 12 months minimum. The equipment shall be within all accuracy requirements of this specification, with a 72% or greater confidence factor following a calibration interval of 12 months.

**Appendix B** contains three menu quick reference guides, one for each of the Model 395's main group menus:

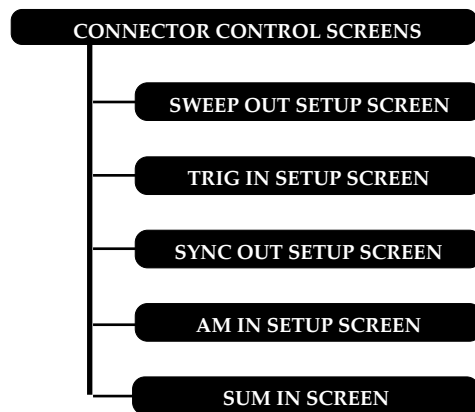
- i. Operational Screen guide
- ii. Connector Control Screen guide
- iii. Numeric Key Group Screen guide

For details on items in these guides, refer to Section 4 of this manual.

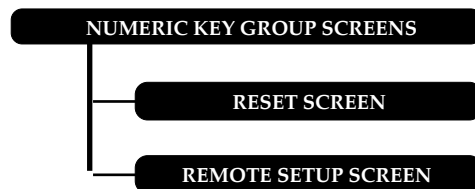


**Legend:**

*For Operational Screen Selections:  
 Select using one of the Beige Front Panel (double row) Keys directly below the gray display group.  
 To select or modify the displayed screen parameters, press one of the gray Function Keys (F1 thru F8) around the display or use the Knob and/or cursor keys to modify if desired item is already selected.*

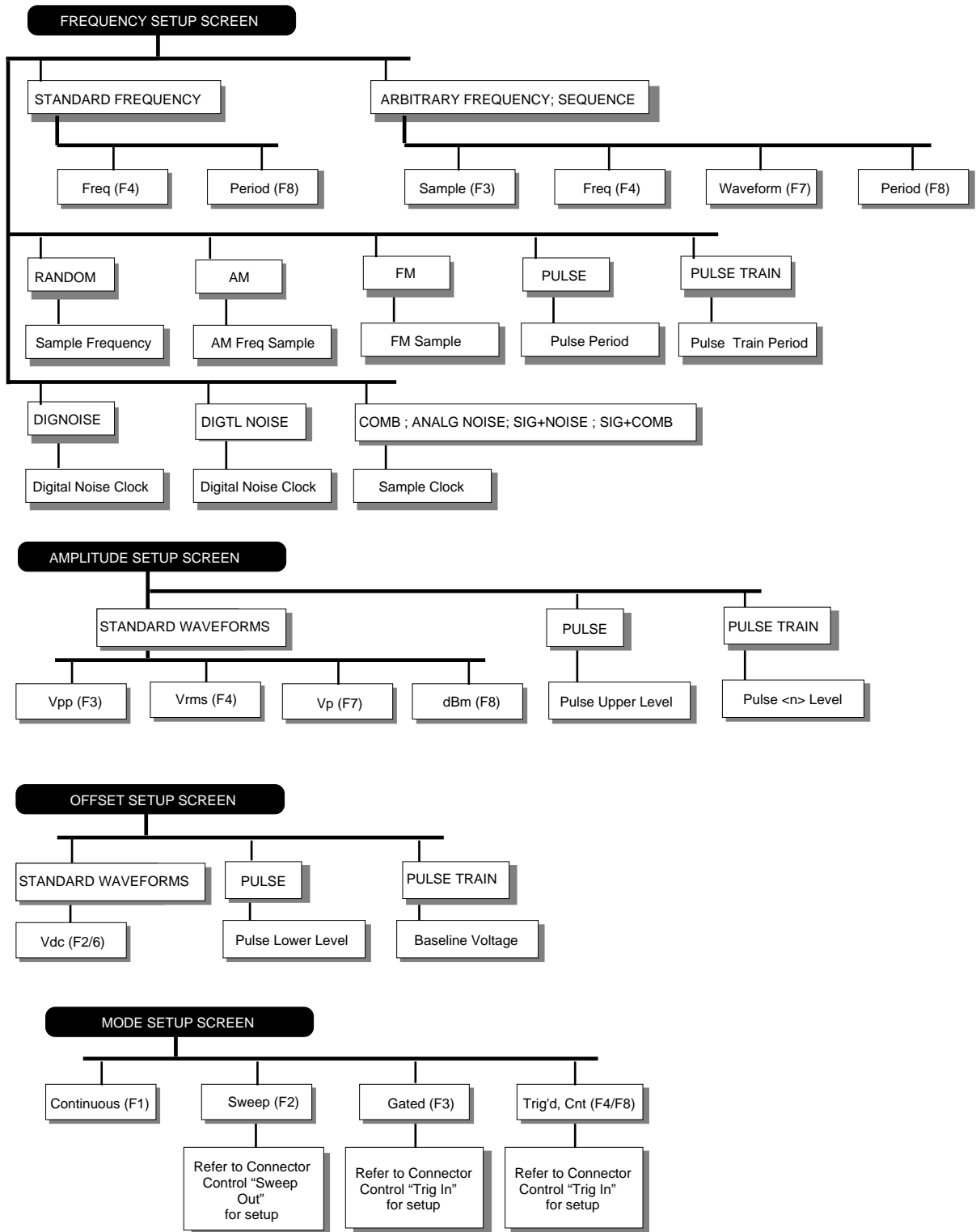


*For Connector Control Screen Selections:  
 Select using one of the Beige Front Panel Keys directly above the Front Panel Connector.  
 To select or modify the displayed screen parameters, press one of the gray Function Keys (F1 thru F8) around the display or use the Knob and/or cursor keys to modify if desired item is already selected.*

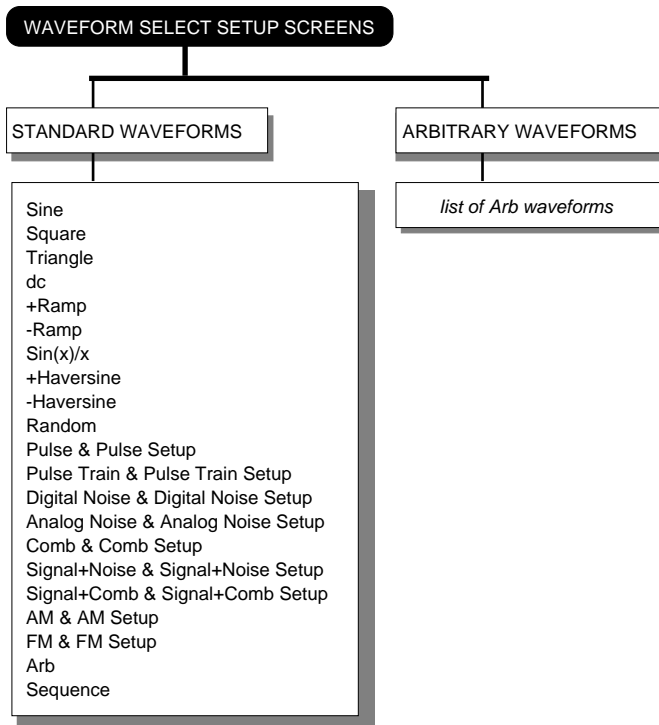
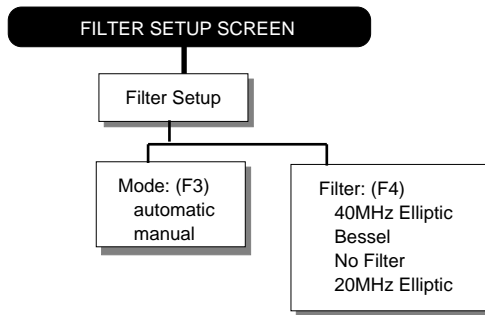
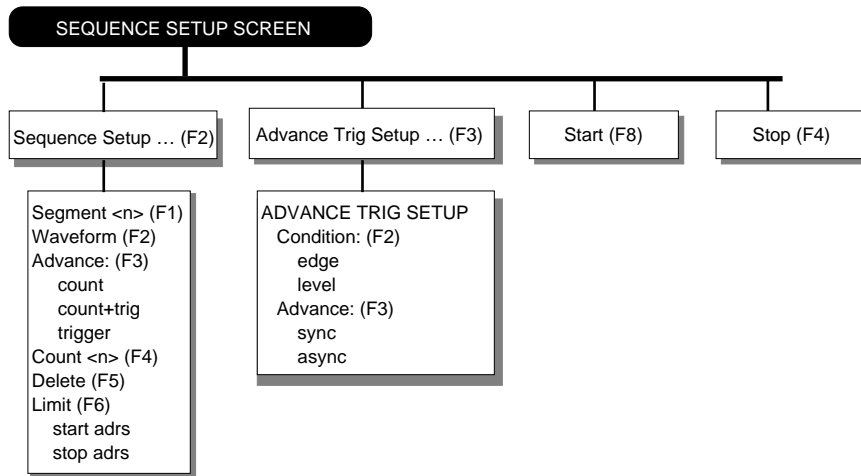


*For Numeric Key Group Screen Selections:  
 Select using one of the Beige Front Panel Keys directly to the right of the gray display group.  
 To select or modify the displayed screen parameters, press one of the gray Function Keys (F1 thru F8) around the display or use the Knob and/or cursor keys to modify if desired item is already selected.*

**Figure B-1. Menu Quick Reference Legend**



**Figure B-2. Operational Setup Screens**



**Figure B-2. Operational Setup Screens (Cont.)**

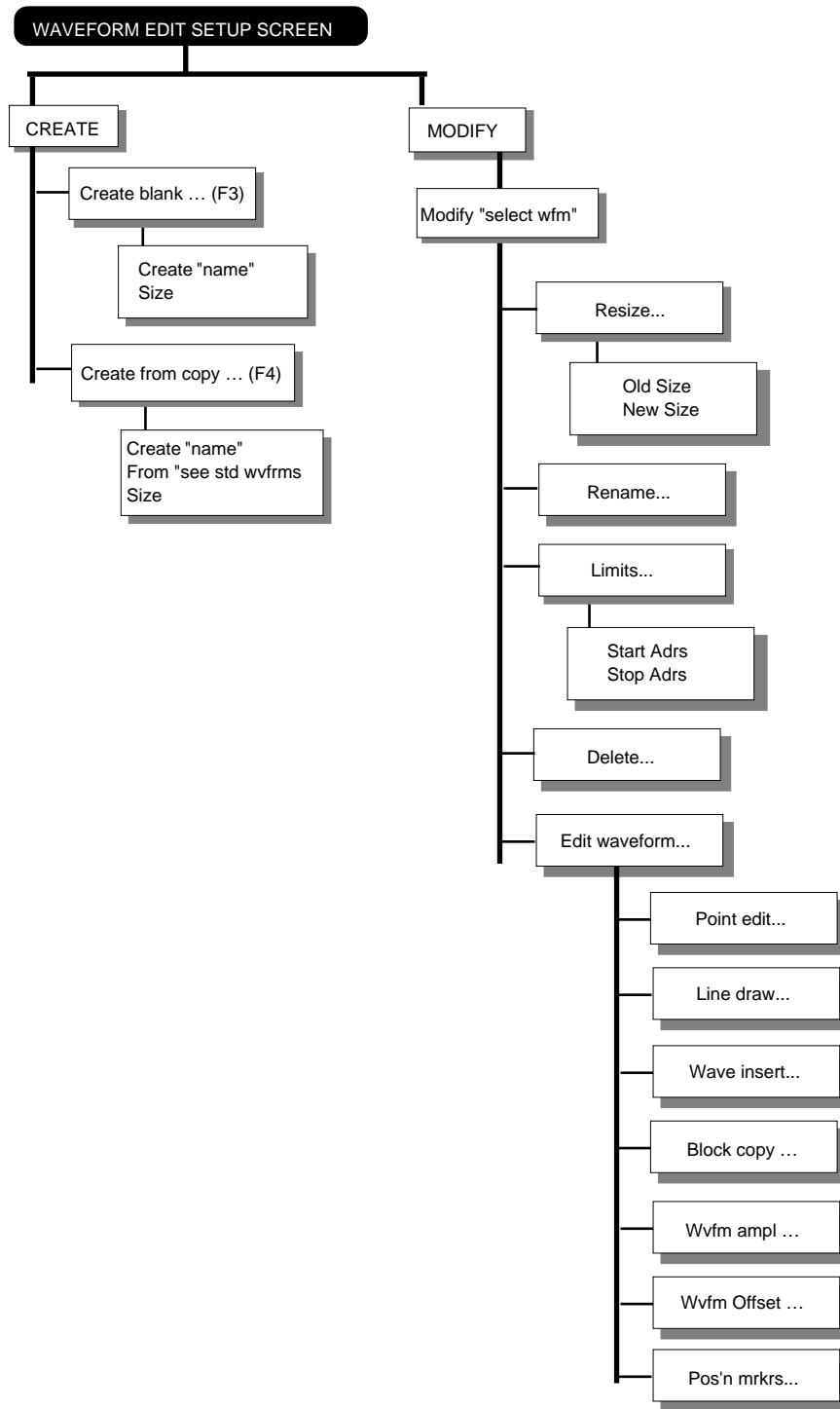


Figure B-2. Operational Setup Screens (Cont.)

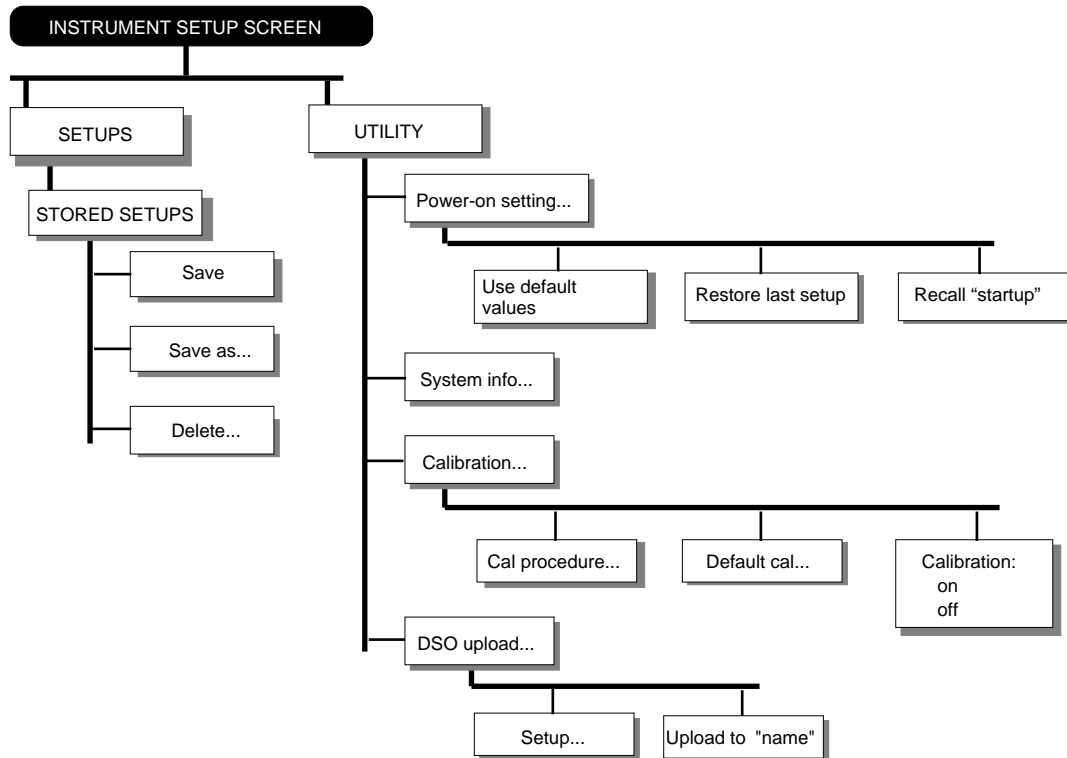
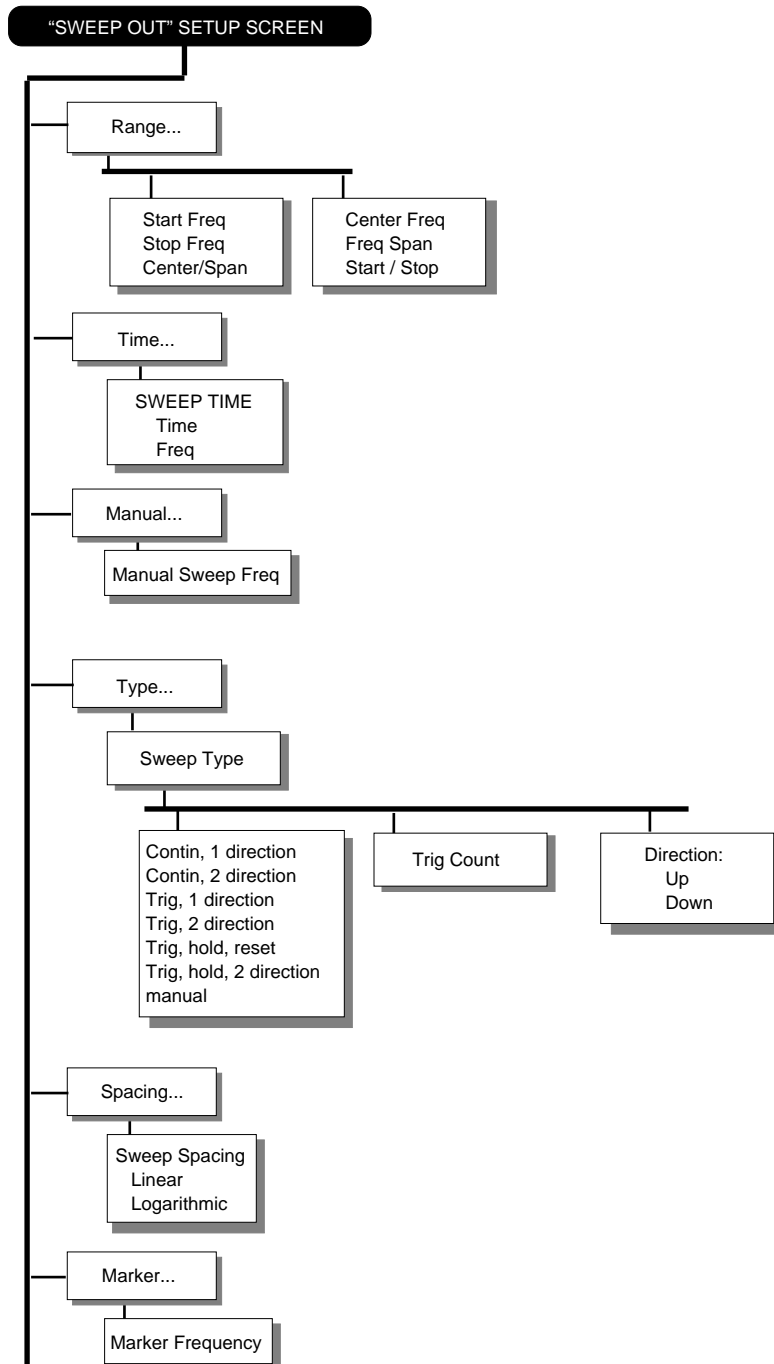
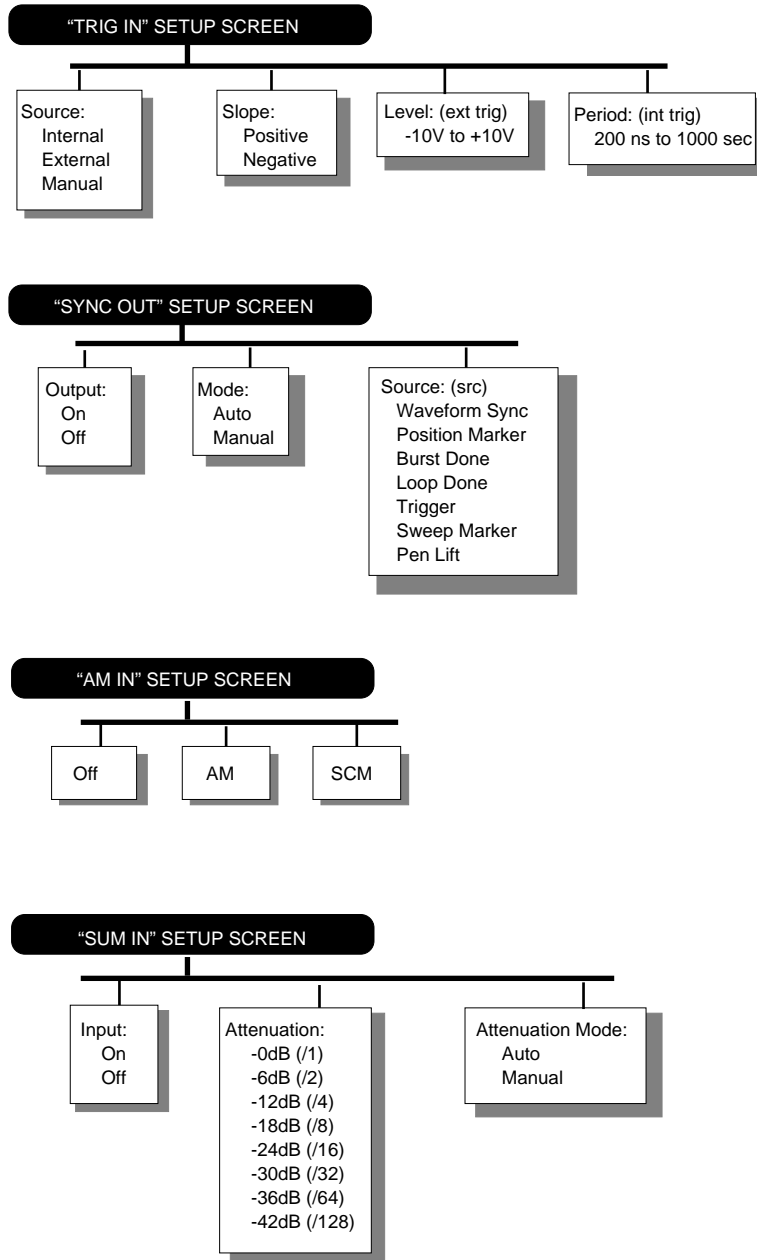


Figure B-2. Operational Setup Screens (Cont.)

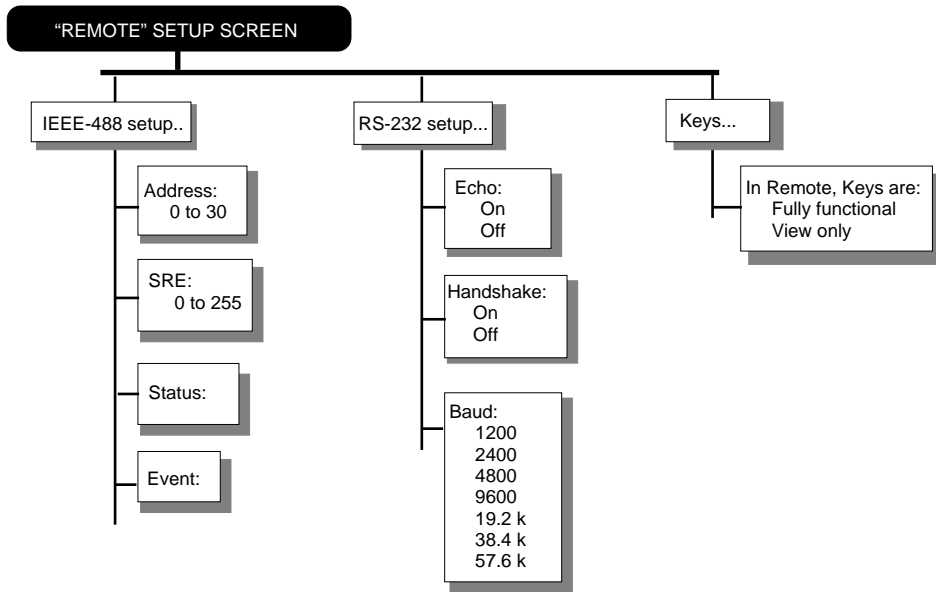
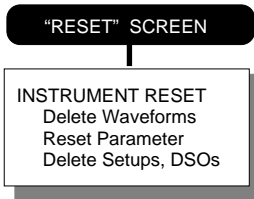




**Figure B-3. Connector Control Screens**



**Figure B-3. Connector Control Screens (Cont.)**



**Figure B-4. Numeric Key Group Screens**



## C.1 INTRODUCTION

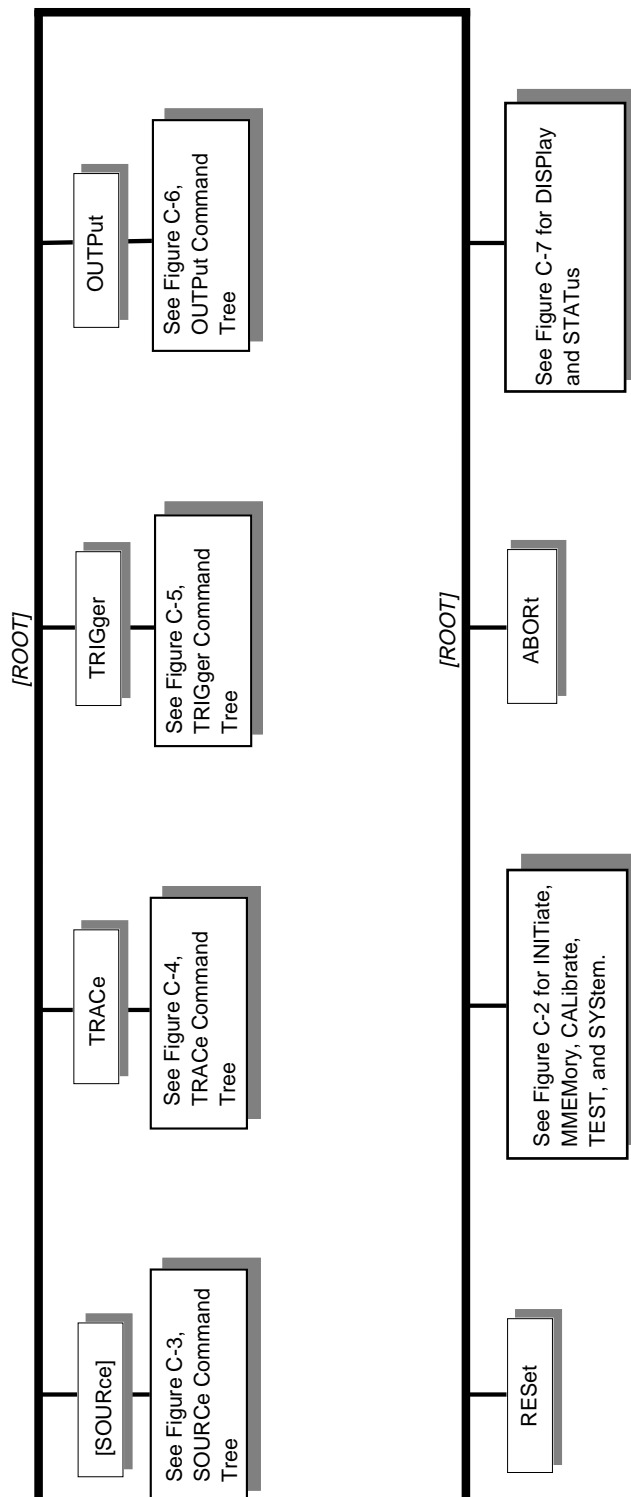
Appendix C summarizes the Model 395 SCPI (Standard Commands for Programmable Instrumentation) commands in two formats: command tree figures and command table. These figures and the table provide a quick overview of the commands used by the Model 395 and do not contain a great deal of detail. Section 5 of this manual contains detailed descriptions of each of the commands.

## C.2 MODEL 395 SCPI COMMAND TREES

Figures C-1 through C-7 provide the programmer/operator a complete set of SCPI Command trees for the Model 395. These trees are an alternate method to the Command Table of constructing syntactically correct SCPI commands.

## C.3 MODEL 395 SCPI COMMAND TABLE

Table C-1, Model 395 SCPI Command Syntax, provides the programmer/operator with a complete set of SCPI Commands for the Model 395. The Command Table provides another alternate method of constructing syntactically correct SCPI commands. Plus, the command table includes “SCPI Conformance Information” as required by the SCPI specification.



**Figure C-1. Subsystems (Root Node)**

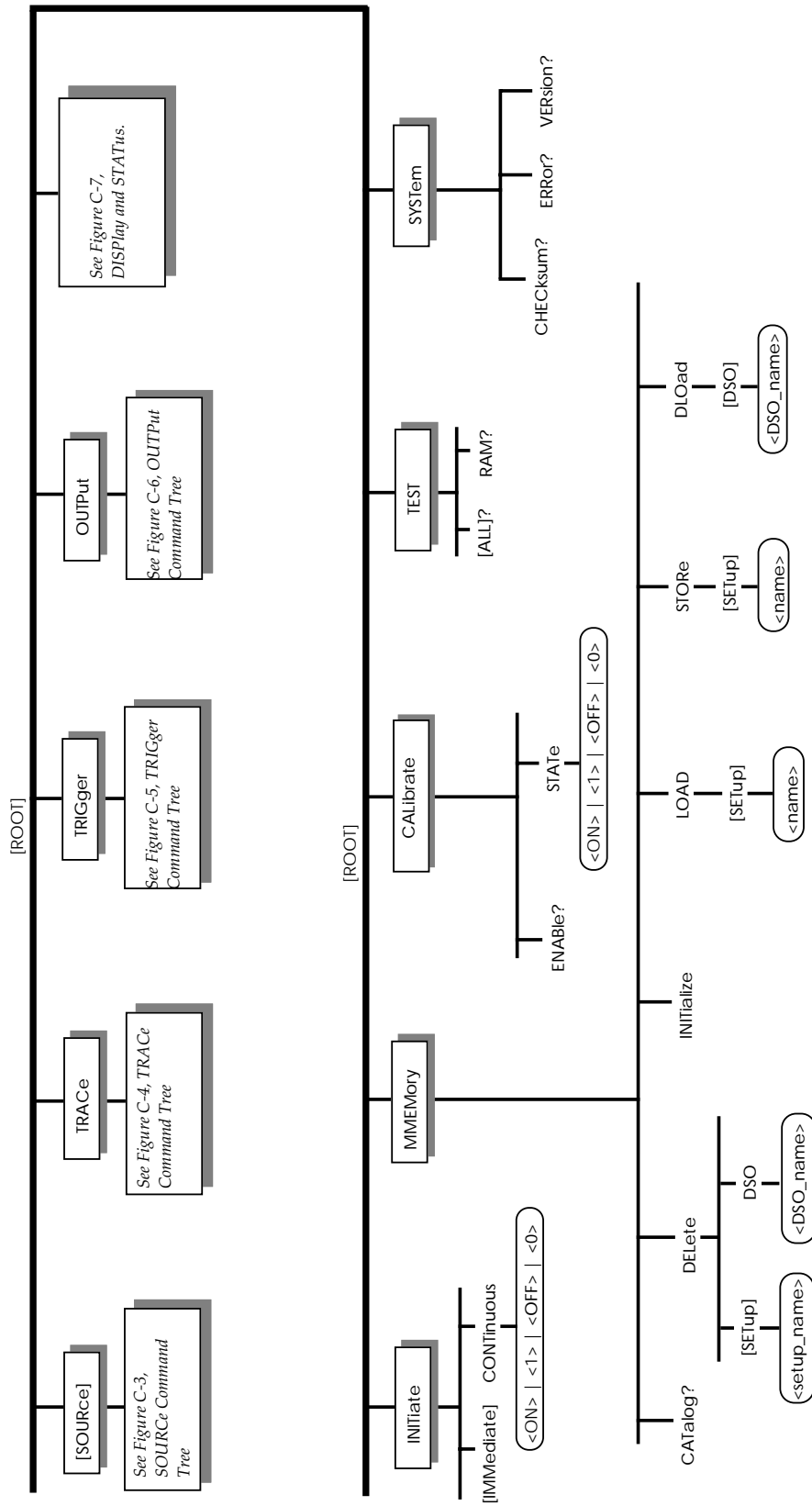


Figure C-2. INITiate, MMEMory, CALibrate, TEST, and SYSTEM Subsystems





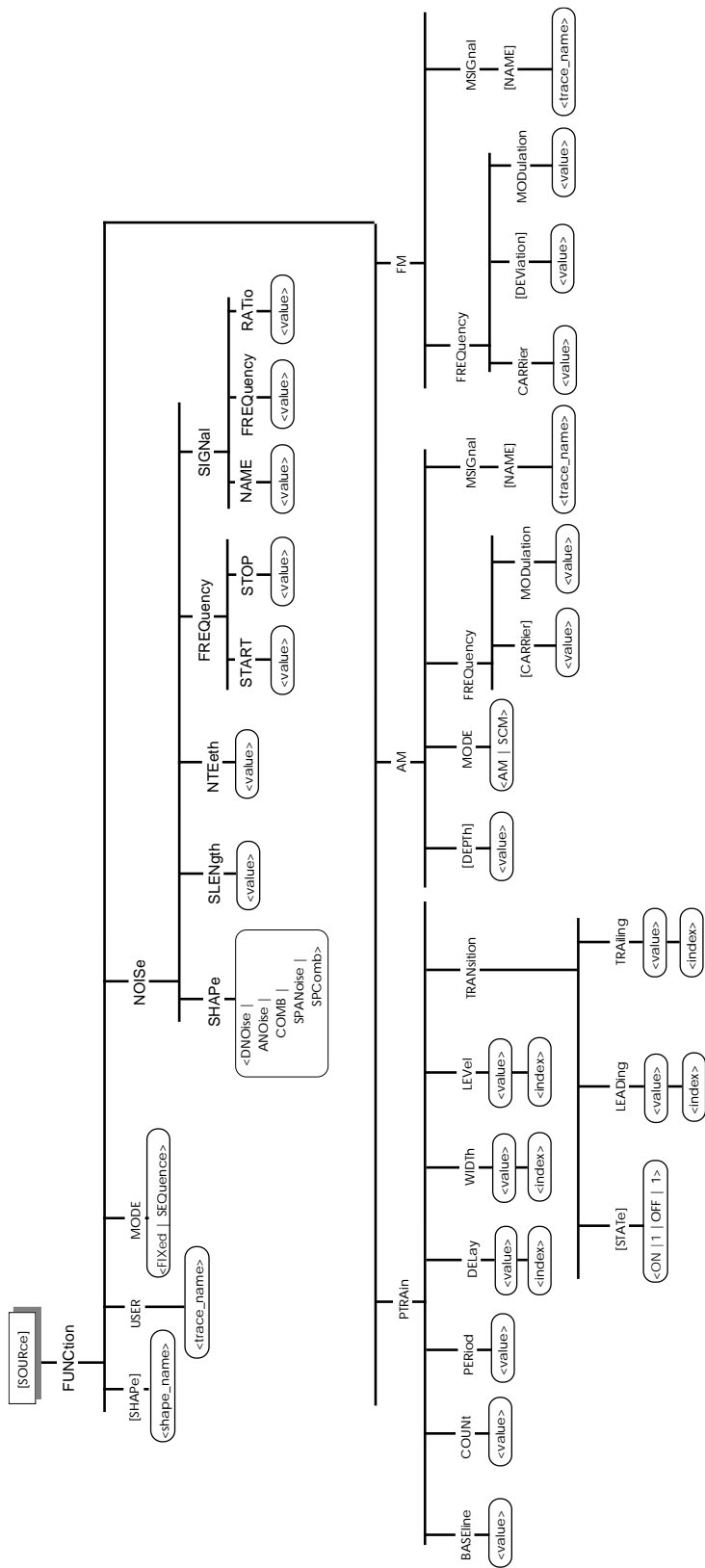


Figure C-3a. SOURce:FUNCTION Subsystem

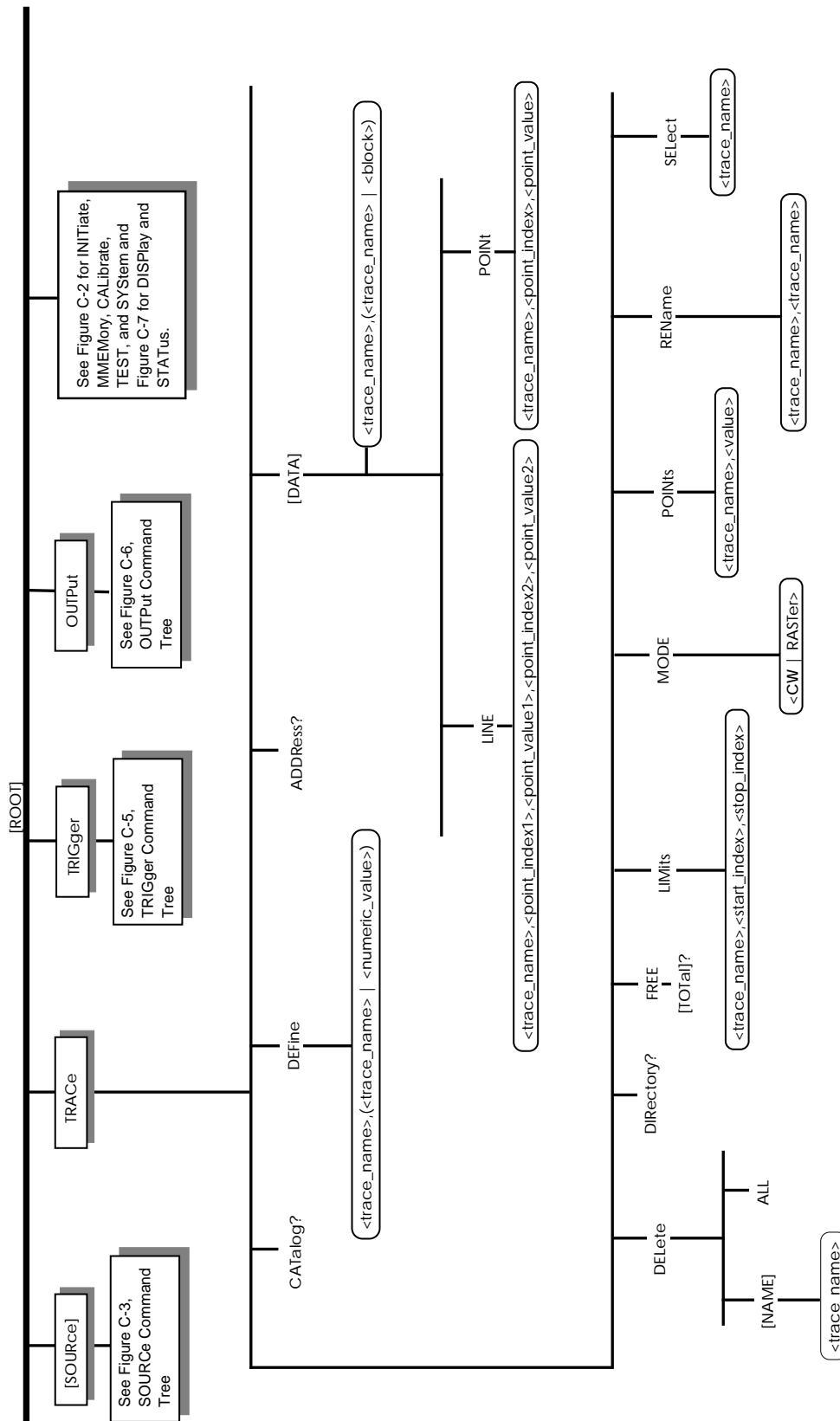


Figure C-4. TRACe Subsystem

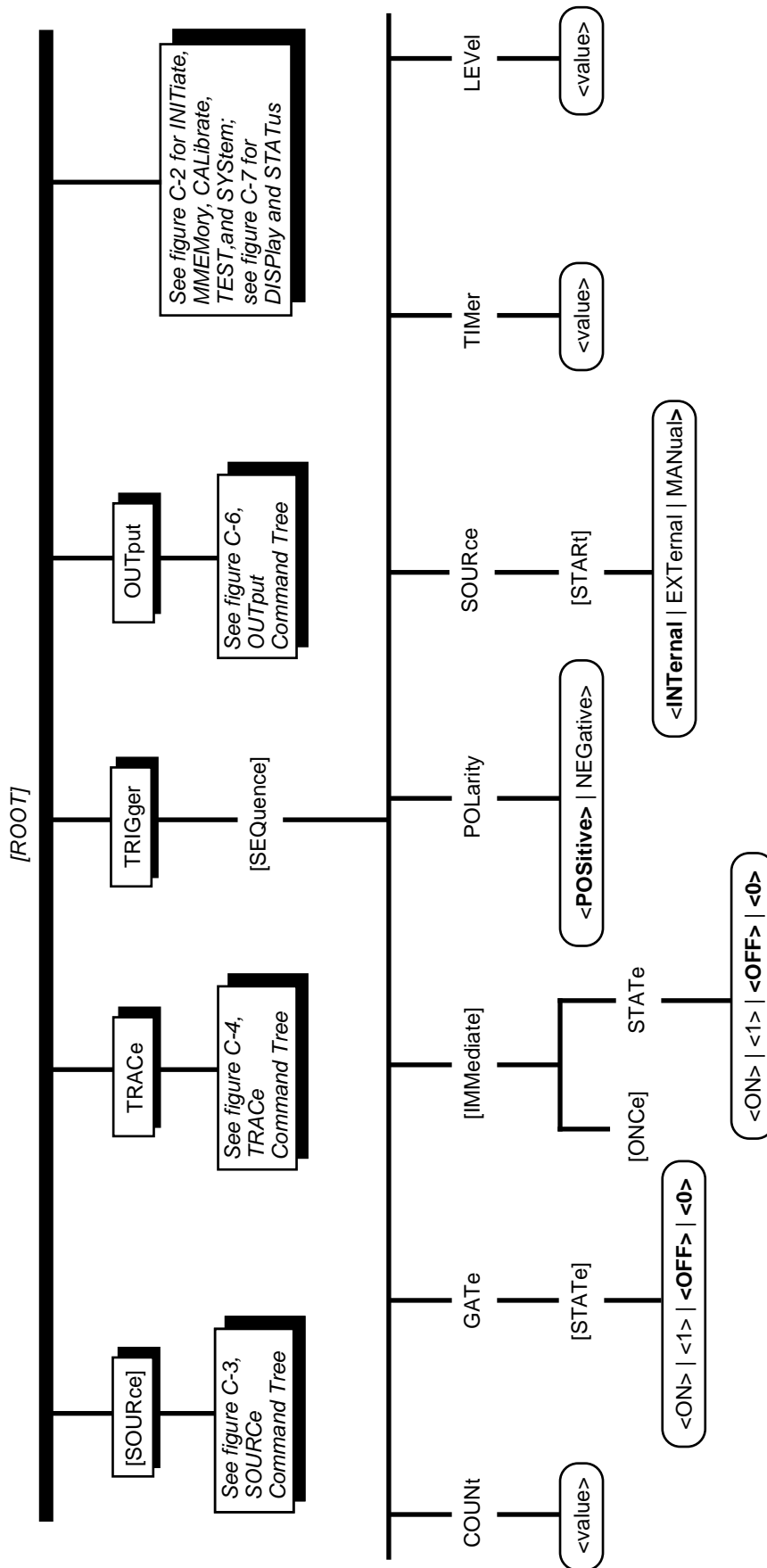


Figure C-5. TRIGGER Subsystem

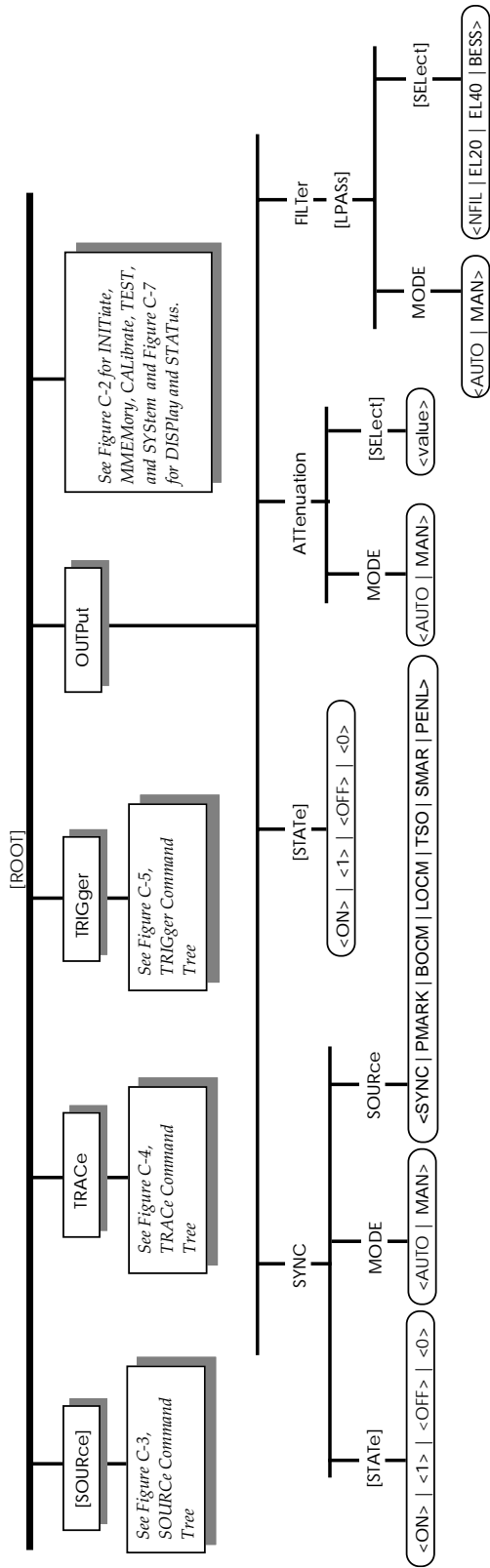


Figure C-6. OUTPUT Subsystem

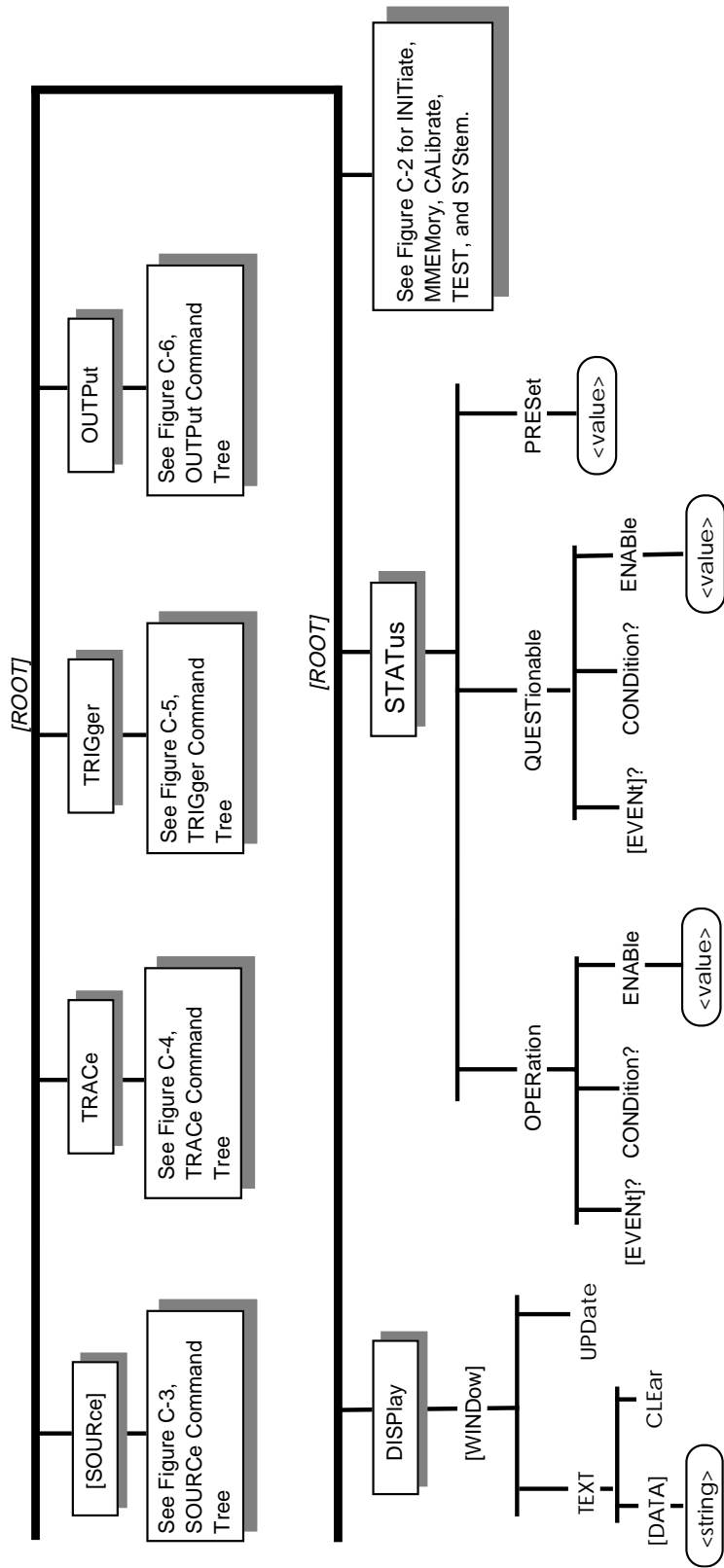


Figure C-7. DISPlay and STATus Subsystems

---

## SCPI CONFORMANCE INFORMATION

This Appendix contains compliance data as required by SCPI 1992 Specification, Volume 1: Syntax and Style. Specifically, paragraph 4.2.3, Documentation Requirements, specifies the Conformance Information requirements for SCPI products.

### Model 395 SCPI Version

The Model 395 100 MHz Synthesized Arbitrary Waveform Generator has been designed to comply with SCPI Version 1992.0, dated February 1992.

### Model 395 SCPI Command Syntax

The SCPI specification, Version 1992.0, defines three type of SCPI commands which may be used in a SCPI product: Confirmed Commands, Approved Commands, and Not SCPI Approved Commands.

### SCPI Confirmed Commands

Confirmed Commands are those commands which are published in SCPI 1992 Specification, Volume 2: Command Reference. Refer to Table C-1 for the complete syntax of Model 395 SCPI commands. Model 395 Confirmed Commands will be identified with the notation “Confirmed” in the third column.

### SCPI Approved Commands

Approved Commands are those commands that have been approved by the SCPI Consortium, but are not published in the SCPI 1992 Specification. Refer to Table C-1 for the complete syntax of Model 395 SCPI commands. Model 395 Approved Commands will be identified with the notation “Approved” in the third column.

### Not SCPI Approved Commands

The SCPI Specification does allow products using the SCPI language to have specialized commands included which are outside of the SCPI definition. Refer to Table C-1 for the complete syntax of Model 395 SCPI commands. Any Model 395 commands that are not in the SCPI definition are identified with the notation “Not SCPI Approved” in the third column.

### Incomplete Command Implementation

The SCPI definition specifies each command completely, and if the command keyword is at the *leaf node*, it specifies the parameter data and query responses. In some cases, a SCPI product may not implement all of the choices given in the specification.

For example, when parameter character data is in the form of a list of choices, the product’s hardware may not support all of those choices:

```
[SOURce]:FREQuency:MODE <CW|FIXed|SWEep|LIST|SENSe>
```

In this example, a complete list of possible Frequency Modes is given. However, the product’s feature set may want to have a settable Frequency Mode in order to set a CW|FIXED frequency, and to enter a Frequency Sweep Mode. The other Modes, LIST and SENSe, may not have any hardware to support them. In this case, the SCPI Syntax Table (refer to Table C-1) would use footnotes to indicate partial conformance to the SCPI Specification.

**Table C-1. Model 395 SCPI Command Syntax**

<b>KEYWORD</b>	<b>&lt;PARAMETER FORM&gt; (min. , max, ; default)</b>	<b>NOTES</b>
<b>CALibrate</b> (see 5.6.2) :ENABle? :STATe	  <Boolean> ( <b>on,1</b> ; off,0)	Confirmed  Confirmed Confirmed
<b>DISPlay</b> [:WINDow] TEXT [:DATA] :CLEar :UPDate	  <data_string> <data_string>	Confirmed Not SCPI Approved Not SCPI Approved Not SCPI Approved Not SCPI Approved Not SCPI Approved
<b>INITiate</b> [:IMMediate] :CONTInuous	  <Boolean> ( <b>on,1</b> ; off,0)	Confirmed Confirmed Confirmed
<b>MMEMory</b> :CATalog? :DELete [:SETup] :DSO :INITialize :LOAD [:SETup] :STORe [:SETup] :DLOAD [:DSO]	  <setup_name> <DSO_name>  <setup_name>  <setup_name>  <DSO_name>	Confirmed Confirmed <sup>1</sup> Confirmed <sup>1,2</sup> Not SCPI Approved Not SCPI Approved Not SCPI Approved Not SCPI Approved Not SCPI Approved Not SCPI Approved Not SCPI Approved Not SCPI Approved
<b>OUTPut</b> :ATTenuation :MODE [:SElect] :FILTer [:LPASs] :MODE [:SElect] [:STATe] :SYNC [:STATe] :MODE :SOURce	  <AUTO   MANual> <intger_value> (0 , 42; 0)  <AUTO   MANual> <NFILter EL20 EL40 BESSel> <Boolean> (on, 1; off, 0)  <Boolean> (on, 1; off, 0) <AUTO MANual> <SYNCmarker PMARker BCOMplete LCOMplete  TSource SMARker PENLift>	Confirmed  Not SCPI Approved Not SCPI Approved Confirmed Confirmed Not SCPI Approved Not SCPI Approved Confirmed Not SCPI Approved Not SCPI Approved Not SCPI Approve Not SCPI Approved
<b>RESet</b>		Confirmed

Table C-1. Model 395 SCPI Command Syntax (Continued)

KEYWORD	<PARAMETER FORM> (min. , max. ; default)	NOTES
[SOURce]		Confirmed
:AM		Confirmed
[:STATe]	<Boolean> (on, 1; <b>off</b> , 0)	Confirmed
:MODE	<AM   SCM>	Not SCPI Approved
:FREQuency		Confirmed
[:CW   FIXed ]	<real_numeric_value> (1e-6, 5e7; <b>1e3</b> )	Confirmed
:MANual	<real_numeric_value> (1e-1, 2e7; <b>1e3</b> )	Confirmed
MODE	<CW   <b>FIXed</b>   SWEep>	Confirmed <sup>2</sup>
:RASTer	<real_numeric_value> (1e-1, 1e8; <b>5e7</b> )	Not SCPI Approved
:STARt	<real_numeric_value> (1e-3, 2e7; <b>1e3</b> )	Confirmed
:STOP	<real_numeric_value> (1e-3, 2e7; <b>1e4</b> )	Confirmed
:FUNction		Confirmed
[:SHAPe]	<shape_name>	Confirmed
:USER	<trace_name>	Not SCPI Approved
:MODE	< <b>FIXed</b>   SEQuence>	Confirmed <sup>1</sup>
AM	Not SCPI Approved	
[:DEPTH]	<integer_value> (0, 200; <b>50</b> )	Not SCPI Approved
:MODE	<AM   SCM>	Not SCPI Approved
:FREQuency		Not SCPI Approved
[:CARRier]	<numeric_value> (0.01, 4e7; <b>1e6</b> )	Not SCPI Approved
:MODulation	<numeric_value> (0.01, 4e7; <b>1e3</b> )	Not SCPI Approved
:MSIGnal		Not SCPI Approved
[:NAME]	<trace_name>	Not SCPI Approved
:FM		Not SCPI Approved
[:FREQuency]		Not SCPI Approved
:CARRier	<numeric_value> (0.01, 4e7; <b>5e6</b> )	Not SCPI Approved
[:DEViation]	<numeric_value> (0.01, 4e7; <b>4e3</b> )	Not SCPI Approved
:MODulation	<numeric_value> (0.01, 4e7; <b>2e4</b> )	Not SCPI Approved
:MSIGnal		Not SCPI Approved
[:NAME]	<trace_name>	Not SCPI Approved
:NOISe		
:SHAPe	< <b>DNOise</b>   ANoise   COMB   SPANoise  SPComb>	Not SCPI Approved
:SLENgth	<integer_numeric_value> (63, 131071; <b>1023</b> )	Not SCPI Approved
:NTEeth	<numeric_value> (3, 256; <b>100</b> )	Not SCPI Approved
FREQuency		Not SCPI Approved
:START	<real_numeric_value> (0.01, 1e7; <b>1e6</b> )	Not SCPI Approved
STOP	<real_numeric_value> (0.01, 1e7; <b>2e6</b> )	Not SCPI Approved
:SIGnal		Not SCPI Approved
:NAME	<shape_name>	Not SCPI Approved
:FREQuency	<real_numeric_value> (0.01, 1e7; <b>1e3</b> )	Not SCPI Approved
:RATio	<integer_numeric_value> 1, 99, <b>25</b> )	Not SCPI Approved



**Table C-1. Model 395 SCPI Command Syntax (Continued)**

KEYWORD	<PARAMETER FORM> (min. , max. ; default)	NOTES
<b>[SOURCE]</b> (continued)		
:PTRain		Not SCPI Approved
:BASELine	<real_numeric_value> (-5.0, 5.0; 5.0)	<b>Not SCPI Approved</b>
:COUNT	<integer_numeric_value> (1, 10; 10)	<b>Not SCPI Approved</b>
PERiod	<real_numeric_value> (1e-7, 655000.0; <b>3e-4</b> )	Not SCPI Approved
:LEVel	<real_numeric_value>, <integer_numeric_value> (-5.0, 5.0; <b>5.0</b> ) , (0, 9; 0)	Not SCPI Approved
:DELay	<real_numeric_value>, <integer_numeric_value> (-654345, 654345; <b>0.0</b> ) , (0, 9; 0)	Not SCPI Approved
:WIDTh	<real_numeric_value>, <integer_numeric_value> (1e-8, 654345; <b>1e-6</b> ) , (0, 9; 0)	Not SCPI Approved
:TRANSition		
[:STATe]	<Boolean> ( <b>on, 1</b> ; off, 0)	Not SCPI Approved
:LEADing	<real_numeric_value>, <integer_numeric_value> (5e-8, 654345; <b>1e-7</b> ) , (0, 9; 0)	Not SCPI Approved
:TRAILing	<real_numeric_value>, <integer_numeric_value> (5e-8, 654345; <b>1e-7</b> ) , (0, 9; 0)	Not SCPI Approved
:MARKer		Confirmed
[:POSition]		Not SCPI Approved
:AOff	<trace_name>	Not SCPI Approved
:POINt	<trace_name>, <point_index>	Not SCPI Approved
:FREQuency	<real_numeric_value> (1e-3, 2e7; <b>1e3</b> )	Not SCPI Approved
:PULSe		Confirmed
:PERiod	<real_numeric_value> (1e-7, 655000.0; <b>3e-4</b> )	Confirmed
:DELay	<real_numeric_value> (-654345, 654345; <b>0.0</b> )	Confirmed
:WIDTh	<real_numeric_value> (1e-8, 654345; <b>1e-6</b> )	Confirmed
:TRANSition		Confirmed
[STATe]	<Boolean> ( <b>on, 1</b> ; off, 0)	Confirmed
:LEADing	<real_numeric_value> (5e-8, 654345; <b>1e-7</b> )	Confirmed
:TRAILing	<real_numeric_value> (5e-8, 654345; <b>1e-7</b> )	Confirmed
:SEQuence		Not SCPI Approved
:ADVance	<AUTO   TRIGgered> , (0, 3; 0)	Not SCPI Approved
:DWELl	<integer_numeric_value> , <integer_numeric_value> (0, 65535; 0) , (0, 3; 0)	Not SCPI Approved
:FUNCTion	<trace_name> , <integer_numeric_value> (0, 3; 0)	Not SCPI Approved
:LENGth	<integer_numeric_value> (2, 4; 2)	Not SCPI Approved
:TRIGger		Not SCPI Approved
:MODE	<SYNChronous   ASYNchronous>	Not SCPI Approved
:SENSe	<EDGE   LEVel>	Not SCPI Approved
:SUM		Not SCPI Approved
[:STATe]	<Boolean> (on, 1; <b>off, 0</b> )	Not SCPI Approved

Table C-1. Model 395 SCPI Command Syntax (Continued)

KEYWORD	<PARAMETER FORM> (min. , max. ; default)	NOTES
<b>[SOURce]</b> (continued)		
:SWEep		Confirmed
:COUNT	<integer_numeric_value> (1, 1000000; 1)	Confirmed
:DIRection	<UP   DOWN>	Confirmed
:MODE	<CRESet TRESet HRESet CREVerse TRESVerse   HRESVerse  MANual>	Confirmed <sup>1</sup>
:SPACing	<LINear   LOGarithmic>	Confirmed
:TIME	<real_numeric_value> (3e-2, 1e3; 1e0)	Confirmed
:VOLTage		Confirmed
[:LEVel]		Confirmed
[:IMMediate]		Confirmed
[:AMPLitude]	<real_numeric_value> (-5.0, 5.0; 1.0 )	Confirmed
:OFFSet	<real_numeric_value> (-5.0, 5.0; 0.0)	Confirmed
:HIGH	<real_numeric_value> (-5.0, 5.0; 1.0)	Confirmed
:LOW	<real_numeric_value> (-5.0, 5.0; -1.0)	Confirmed
<b>SYSTEM</b>		Confirmed
:CHECKsum?		Not SCPI Approved
:ERRor?		Confirmed
:VERSion?		Confirmed
<b>STATus</b>		Confirmed <sup>3</sup>
:OPERation		Confirmed <sup>3</sup>
:CONDition?		Confirmed <sup>3</sup>
:ENABle	<integer_numeric_value> (0, 32767; 0)	Confirmed <sup>3</sup>
[:EVENt]?		Confirmed <sup>3</sup>
:QUEStionable		Confirmed <sup>3</sup>
:CONDition?		Confirmed <sup>3</sup>
:ENABle	<integer_numeric_value> (0, 32767; 0)	Confirmed <sup>3</sup>
[:EVENt]?		Confirmed <sup>3</sup>
:PREset	<integer_numeric_value> (0, 32767; 0)	Confirmed <sup>3</sup>
<b>TEST</b>		Confirmed
[:ALL]?		Confirmed <sup>1</sup>
:RAM?		Confirmed <sup>1</sup>

**Table C-1. Model 395 SCPI Command Syntax (Continued)**

KEYWORD	<PARAMETER FORM> (min. , max, ; default)	NOTES
<b>TRACe</b>		Confirmed
:CATalog?		Confirmed
[:DATA]	<trace_name>,(<trace_name> <block>)	Confirmed
:LINE	<trace_name>,<point_index1>,<point_value1>,<point_index2>,<point_value2>	Confirmed
:POINT	<trace_name>,<point_index>,<point_value>	Not SCPI Approved
:DEFine	<trace_name>,(<trace_name> <integer_numeric_value>) (10, 65536; <b>8192</b> )	Confirmed
:DELete		Confirmed
[:NAME]	<trace_name>	Confirmed
:ALL		Confirmed
:DIRectory?		Not SCPI Approved
:FREE?		Confirmed
[TOTal]	<points available>,<points in use>	Not SCPI Approved
:LIMits	<trace_name>,<start_index>,<stop_index> (0, 131071; <b>0</b> ) , (0, 131071; <b>0</b> )	Not SCPI Approved
:MODE	<CW RASTer>	Not SCPI Approved
:POINTs	<trace_name>,<integer_numeric_value> (5, 32768; <b>8192</b> )	Confirmed
:REName	<old_trace_name>,<new_trace_name>	Not SCPI Approved
SElect	<trace_name>	Not SCPI Approved
<b>TRIGger</b>		Confirmed
[:SEQuence]		Confirmed
:COUNT	<integer_numeric_value> (1, 1048575; <b>1</b> )	Confirmed
:GATE		Not SCPI Approved
[:STATe]	<Boolean> (on, 1; <b>off, 0</b> )	Not SCPI Approved
[:IMMediate]		Confirmed
[:ONCe]		Confirmed
:STATe	<Boolean> (on, 1; <b>off, 0</b> )	Confirmed
:LEVel	<real_numeric_value> (-10.0, 10.0; <b>0.0</b> )	Confirmed
:POLarity	<POSitive NEGative>	Not SCPI Approved
:SOURce		Confirmed <sup>1</sup>
[:START]	<INTernal EXTernal MANual>	Not SCPI Approved
:TIMer	<real_numeric_value> (2e-7, 1e4; <b>5e-3</b> )	Confirmed

1. Device dependent parameter character data.
2. Incomplete implementation; at least one parameter not supported per SCPI specification.
3. STATus Subsystem commands operate per the specification, but the physical Status Registers are not implemented in the hardware.



## D.1 RACK EARS KIT INSTRUCTIONS

First, make sure these parts are included in the Rack Ears kit.

Description	Qty	Wvtk P/N	Fig. D-1 Ref.
Assembly Drawing	1	1101-00-3708	
Top Cover	1	1400-02-5301	5
Adhesive backed cover plate	1	1400-02-5302	7
10-32X 1/2 inch Screw	8	2800-20-0208	4
6-32X 1/4 inch Screw	6	2800-40-6104	6

Refer to Figure D-1 Model 395 Rack Adapter Ears on the following page while performing these step-by-step instructions.



### WARNING

First disconnect any signal connections, then the AC line supply cord.

### Removal

1. Remove the top cover screws (item 2), which are located on the lower rear left and right sides.
2. Slide top cover (item 1) back and off the unit.
3. Remove the four screws (item 8) and feet located at the bottom of the unit.
4. Retain the top cover, feet, and screws for future use.

### Rack Mount Kit Installation

1. Install the new top cover (item 5) using four 6-32 x 1/4 screws (item 6).
2. Mount the Rack Ears (item 3, two places) as shown in figure D-1 using six 10-32 x 1/2 screws (three per side).
3. Remove the adhesive backing from the cover plate, and Install the cover plate (item 7) over the hole shown in View A-A.



### CAUTION

Failure to install the top cover could cause excessive EMI and/or improper cooling.

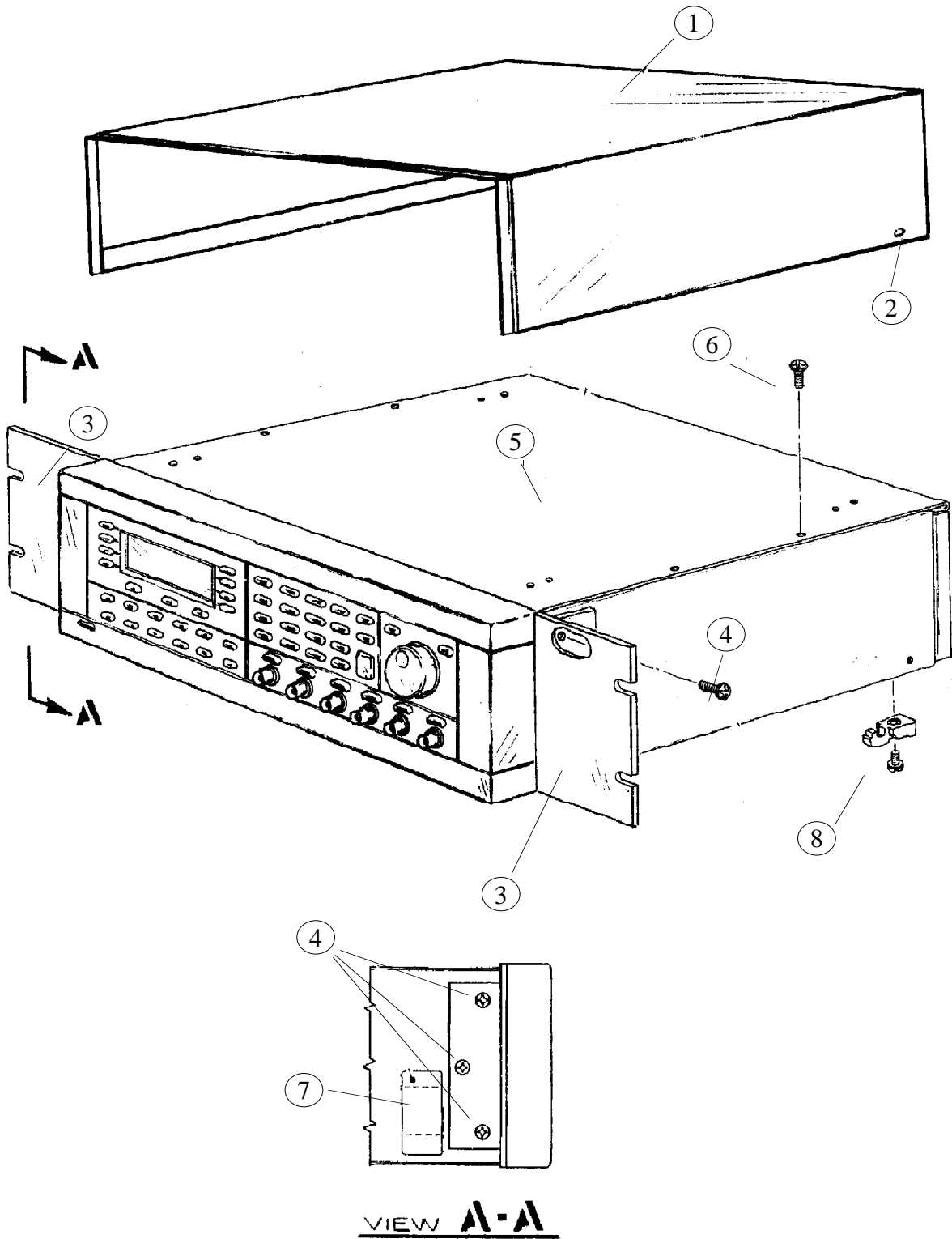


Figure D-1. Model 395 Rack Ears Kit

## E.1 INTRODUCTION

This appendix lists error messages that will be generated during operation.

## E.2 SCPI MESSAGES

Below is a list of SCPI error messages that might occur during operation. Each is listed inside quotes. For a detailed description of what each error code means, refer to the 1993 SCPI Command Reference manual, Chapter 21, "SYSTem:ERRor?"

0,	"No error"
-100,	"Command error"
-101,	"Invalid character"
-102,	"Syntax error"
-103,	"Invalid separator"
-104,	"Data type error"
-105,	"GET not allowed"
-108,	"Parameter not allowed"
-109,	"Missing Parameter"
-110,	"Command header error"
-111,	"Header separator error"
-112	"Program mnemonic too long"
-113	"Undefined header"
-114	"Header suffix out of range"
-120	"Numeric data error"
-121	"Invalid character in number"
-123	"Exponent too large"
-124	"Too many digits"
-128	"Numeric data not allowed"
-130	"Suffix error"
-131	"Invalid suffix"
-134	"Suffix too long"
-138	"Suffix not allowed"
-140	"Character data error"
-141	"Invalid character data"
-144	"Character data too long"
-148	"Character data not allowed"
-150	"String data error"
-151	"Invalid string data"
-158	"String data not allowed"
-160	"Block data error"
-161	"Invalid block data"
-168	"Block data not allowed"
-170	"Expression error"

---

-171	“Invalid expression”
-178	“Expression data not allowed”
-180	“Macro error”
-181	“Invalid outside macro definition”
-183	“Invalid inside macro definition”
-184	“Macro parameter error”
-200	“Execution error”
-201	“Invalid while in local”
-202	“Settings lost due to rtl”
-210	“Trigger error”
-211	“Trigger ignored”
-212	“Arm Ignored”
-213	“Init ignored”
-214	“Trigger deadlock”
-215	“Arm deadlock”
-220	“Parameter error”
-221	“Settings conflict”
-222	“Data out of range”
-223	“Too much data”
-224	“Illegal parameter value”
-230	“Data corrupt or stale”
-231	“Data questionable”
-240	“Hardware error”
-241	“Hardware missing”
-250	“Mass storage error”
-251	“Missing mass storage”
-252	“Missing media”
-253	“Corrupt media”
-254	“Media full”
-255	“Directory full”
-256	“File name not found”
-257	“File name error”
-258	“Media protected”
-260	“Expression error”
-261	“Math error in expression”
-270	“Macro error”
-271	“Macro syntax error”
-272	“Macro execution error”
-273	“Illegal macro label”
-274	“Macro parameter error”
-275	“Macro definition too long”
-276	“Macro recursion error”
-277	“Macro redefinition not allowed”
-278	“Macro header not found”
-280	“Program error”
-281	“Cannot create program”
-282	“Illegal program name”
-283	“Illegal variable name”
-284	“Program currently running”
-285	“Program syntax error”



---

-286	“Program runtime error”
-300	“Device-specific error”
-310	“System error”
-311	“Memory error”
-312	“PUD memory lost”
-313	“Calibration memory lost”
-314	“Save/recall memory lost”
-315	“Configuration memory lost”
-330	“Self-test failed”
-350	“Queue overflow”
-400	“Query error”
-410	“Query INTERRUPTED”
-420	“Query UNTERMINATED”
-430	“Query DEADLOCKED”
-440	“Query UNTERMINATED after indefinite response”

This list contains error and warning messages returned by the Model 395.

”No error”	Error code 0
”Amplitude + Offset > 5.0 Volts”	Error code 1
”Destination trace not defined”	Error code 2
”Missing second argument”	Error code 3
”Trace name already defined”,	Error code 4
”Defined trace size too large”,	Error code 5
”Default trace size too large”,	Error code 6
”Source trace not defined”,	Error code 7
”Block larger than trace size”,	Error code 8
”Playback length < 10 points”,	Error code 9
”Playback length out of bounds”,	Error code 10
”Point out of bounds”,	Error code 11
”Sequence length > trace count”,	Error code 12
”Traces not on 8k boundaries”,	Error code 13
”Not enough memory for resize”,	Error code 14
”First point left of second point”,	Error code 15
”Second point out of bounds”,	Error code 16
”Unable to access application hardware”,	Error code 17
”Not enough memory to create function”,	Error code 18
”Invalid function name”,	Error code 19
”Trace start not on 4k boundary”,	Error code 20
”Trace size not on 4k boundary”,	Error code 21
”Bad enumerated value”,	Error code 22
”Calibration data version invalid”,	Error code 23
”No defined user functions”,	Error code 24
”Unable to allocate memory for operation”,	Error code 25
”Unable to write to EEPROM”,	Error code 26
”Clock BNC configured as output with external clock selected”,	Error code 27
”Stop frequency < start frequency”,	Error code 28
”Sweep frequency out of range”,	Error code 29
”Command supported only by slot 1”,	Error code 30

---

"Frequency out of range for function",	Error code 31
"Unused error code",	Error code 32
"Self calibration data invalid",	Error code 33
"Manual calibration data invalid",	Error code 34
"Store setup error",	Error code 35
"Recall setup, missing waveform",	Error code 36
"Recall setup, incompatible version",	Error code 37
"Trigger gate must be on",	Error code 38
"Cal Enable switch must be in CAL position",	Error code 39
"Frequency must be 5 MHz for trigger operation",	Error code 40
"Cannot sweep a sequence",	Error code 41
"Trace size must be an even number",	Error code 42
"Trace start must be an even number",	Error code 43
"Trace stop must be an odd number",	Error code 44
"Deleted trace being output, Func Out is now Sine ",	Error code 45
"Sequence not properly defined"	Error code 46
"Backup RAM contents invalid, RAM has been re-initialized",	Error code 47
"Cannot gate a sequence",	Error code 48
"Start/Stop frequency ratio > 0.9",	Error code 49
"Signal name not defined",	Error code 50
"Invalid command for selected noise function",	Error code 51
"Noise calculations, waveform clipped",	Error code 52
"Signal Frequency too low",	Error code 53
"Signal Frequency too high",	Error code 54
"Noise calculations, waveform too large",	Error code 55
"Bandwidth > 10MHz",	Error code 56
"Function canceled",	Error code 57
"Noise sequence length too long for function",	Error code 58
"Pulse delay is too negative",	Error code 59
"Trigger count >524287 for sequence not allowed",	Error code 60
"Selected attenuator causes lower amplitude and offset",	Error code 61
"Frequency span (carrier/modulation) too high",	Error code 62
"Function not allowed as signal",	Error code 63
"Frequency too high for AM/FM",	Error code 64
"Function setup error",	Error code 65
"Cannot use selected function as signal",	Error code 66
"Internal Execute Error",	Error code 67
"Maximum number of waveforms have been defined",	Error code 68
"Function: <NAME> not allowed as signal"	
"Pulse <1..10>, <delay,lead,width,trail> s/b "greater or less than" <limit> for this period range"	
"Pulse <1..10>, width too small for lead/trail, must be >limit"	
"Pulse <1..10>, delay + lead + width + trail > period"	
"Pulse <1..10>, delay + lead + width + trail > period"	

---

## E.3 DISPLAYED MESSAGES

The following list contains error messages that might occur during front panel operation.

### **Amplitude/Offset**

Selected attenuator causes lower amplitude and offset

### **AM/FM**

Frequency span (carrier/modulation) too high

Frequency too high for AM/FM

Bandwidth > 10MHz

Start/Stop frequency ratio > 0.9

### **Calibration**

Cal enable switch must be on CAL to access calibration.

Set all calibration constants to default ?

Procedure stopped! Save new cal data ?

Procedure completed! Save new cal data ?

Unable to write to EEPROM

Calibration data version invalid

### **DSO Upload**

DSO upload requires that the IEEE-488 option be installed.

Cannot perform DSO upload while in remote.

### **General**

Data out of Range; min value: x, max value: y

Unable to access application hardware

### **Mode**

Cannot use sweep mode while running a sequence

Cannot sweep pulse functions

Cannot sweep noise functions

Cannot use gated mode while running a sequence

Cannot sweep AM function

Cannot sweep FM function

### **Noise**

Noise calculations, waveform too large

### **Pulses / Pulse Trains**

Pulse delay is too negative

Pulse <1..10>, <delay,lead,width,trail> s/b “greater or less than <limit> for this period range”

Pulse <1..10>, width too small for lead/trail, must be >limit

Pulse <1..10>, delay + lead + width + trail > period

Pulse <1..10>, delay + lead + width + trail > period

### **Remote Setup**

IEEE-488 option not installed

Parameter cannot be changed while remote. Go to local or change Keys setting on Remote screen.

---

## Reset

Delete all arbitrary waveforms ?  
Reset all parameters to default values ?  
Delete all stored setups and downloaded DSO's ?

## Sequence

Cannot run sequence in gated mode  
Cannot run sequence in sweep mode  
Cannot run sequence. Need at least 2 waveforms.  
Start sequence now or wait for external trigger?  
Sequence length > trace count  
Trigger count >524287 for sequence not allowed

## Setups

Setup "NAME" already exists. Overwrite?  
No setups yet exist.  
Delete setup named "NAME" ?  
Store setup error

## Startup messages

Calibration constants invalid (defaults used)  
Waveform memory failed self-test.  
Battery-backed RAM contents invalid. Check battery.

## Sweep

Sweep start frequency must be less than stop.

## Waveform Creation

Maximum number of waveforms have been defined  
Not enough memory to create function

## Waveform Editing

Trace "name" already exists. Overwrite ?  
'name' — bad waveform name. Must begin 'A' to 'Z'  
No arbitrary waveforms defined  
Cannot run pulse, noise, AM, or FM while in sweep mode.  
Cannot insert a waveform into itself!  
'NAME' limits must be set for at least 10 points.  
Remove all markers in "NAME" ?  
Adjusting waveform ampl requires range of 2 or more points  
Cannot edit while sweeping

## F.1 INTRODUCTION

Option 001, GPIB Interface and Direct DSO Waveform Transfer, permits direct binary waveforms transfer between a Digital Storage Oscilloscope (DSO) and the Model 395 via the GPIB interface.

The DSO Upload function currently supports the following Digital Storage Oscilloscopes (DSO):

Gould 1624	Model 1624
Gould 4060	Model 4060
Gould 4090	Model 4090
HP 54602	Model HP 54602
Kikusui 7XXX	Models 7060A, 7061A, 7100A, 7101A, 7200A, and 7201A.
LeCroy 93XX	
LeCroy 94XX <sup>Note 1</sup>	Models 9420, 9424, and 9450
Nicolet	Models 400 and 500 Series
Philips 3382	Model 3382, 3385, 3392, and 3394
Tek 2430	Model 2430
Tek 11402	Model 11402
Tektronix TDS <sup>Note 2</sup>	Models 420, 460, 520, 540, 620, and 640
Tektronix TDSlo <sup>Note 3</sup>	Models 420, 460, 520, 540, 620, and 640
Yokogawa 1200	Model 1200

<sup>Note 1</sup> LEC 94XX driver will perform high resolution 16-bit transfers of waveform data. The uploaded waveform will be scaled to 12-bits. Choose the appropriate source selection.

<sup>Note 2</sup> TEK TDS driver supports the “hi” resolution -> 16 bit transfers for all waveforms.

<sup>Note 3</sup> TEK TDSlo driver supports the “low” resolution -> 8-bit transfers for all waveforms. The driver performs high resolution 16-bit transfers of waveform data, regardless of the acquisition mode. The resolution for waveforms acquired in Sample, Envelope, or Peak-Detect modes is 8-bits; 16 bits for Average and High Resolution modes. The uploaded waveform will be scaled to 12 bits.

### Note

DSO driver and setup can only be done from the Model 395 Utilities screen. Selection and setup of DSO driver cannot be made through SCPI commands.

## F.2 DSO UPLOADING

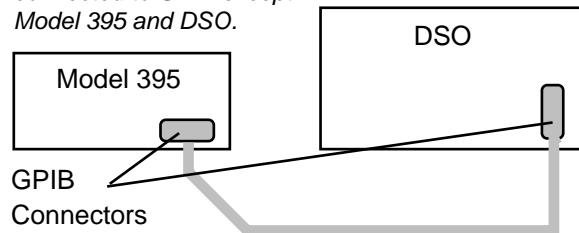
### F.2.1 Initial Setup

Before uploading a waveform from the Digital Storage Oscilloscope to the Model 395, you must:

1. Acquire the waveform in one of the DSO channels, traces, or memories. The DSO operator’s manual explains capturing waveforms on the DSO.
2. Connect a GPIB cable between the Model 395 and the DSO.

---

Remove all equipment connected to GPIB except Model 395 and DSO.



---

### IMPORTANT

While uploading from the DSO, all other equipment must be disconnect from the GPIB bus except the DSO and Model 395. Failure to do so could unpredictable results during waveform transfer.

## F.2.2 Uploading Waveforms

To upload the waveform from the DSO,

1. Press the front panel UTILITY key.
2. From the Utility screen, select “DSO upload ...” (F4 key).
3. Using the F5 key, the left or right cursor keys, or the front panel Knob, select the desired DSO from the list that appears to the left of the F5 key. If your DSO is not listed, refer to paragraph F.3, Creating DSO Drivers.

### Note

The F5 key only scrolls “up” through the list. Use the front panel Knob or the left and right cursor keys to scroll back “down” through the list.

DSO Help is available at two levels. The first is from the “DSO upload...” screen and the more detailed is called from the DSO instrument “setup...” screen. If you create your own DSO driver, you will have to “write” your own “setup” help screen.

4. With your DSO displayed, select “setup ...” (F6 key).
5. From the “DSO SETUP” screen, use the F6 key to set the GPIB address to match the DSO GPIB address. Then press F7 key to select the desired DSO channel or trace containing the captured waveform.
6. When finished with the DSO setup, press the F8 key (done) to return to the DSO screen.
7. From the DSO screen enter name the waveform using a combination of the left and right cursor keys and the front panel knob. The Model 395 stores the uploaded waveform under this name.
8. Press “do upload” (F8) to transfer the waveform.

During waveform transfer the Model 395 screen displays the upload status. If an error occurs during transfer, the screen displays an error message until time-out occurs.

When the waveform transfer is completed, the screen displays “upload complete.” Select “ok” to return to the DSO screen.

The Model 395 retains the selected DSO and its setup conditions until power off.

---

## F.3 CREATING DSO DRIVERS

### IMPORTANT

Writing a DSO driver file is a very complex process. For this reason, it is highly recommended that you be extremely experienced in operating and programming of your DSO. Mistakes in the DSO driver could result in an inaccurate waveform transfer to the Model 395.

If your DSO is not included in the DSO listing, you can write a DSO driver using any general purpose ASCII text editor on any PC compatible computer.

To create a new DSO driver file,

Review paragraph F.3.1 DSO Driver Reference.

Check the DSO manual for GPIB commands for **binary waveform download** or **binary waveform transfer**.

Write the driver file using an ASCII text editor, and load the DSO driver into the Model 395; see paragraph F.4.

### F.3.1 DSO Driver Reference

A DSO driver consists of four description blocks: [id], [setup n], [select n], [format], and [help]. Blocks can be in any order in the file.

[id]	This block contains the DSO make and model that the Model 395 displays on the DSO screen. Each file must contain an “id” block
[format]	This block defines the data format. Items in this block must relate to commands in the [setup n] block. Each file must contain one “format” block.
[setup n]	This block contains the commands that set up the DSO waveform transfer format. This block is optional if the DSO has only one channel or a “default” channel is used. Each file can contain up to two “setup” block. “n” represents the setup block number (1 or 2). Even if only one setup block is used in the file, setup must be numbered (e.g. [setup 1]).
[select n]	This block contains the commands that selects the waveform source (channel, trace, memory etc.) on the DSO. Each file can contain up to twenty “select” blocks. “n” represents the select block number (1 through 20). Even if only one select block is used in the file, setup must be numbered (e.g. [select 1]).
[help]	This block allows the programmer to create help screens for the DSO.

The Model 395 executes the commands in the block when “do upload” is selected on DSO screen. The Model 395 executes the block commands in this order:

first “setup” block followed by the selected “select” block.

Then any additional “setup” and “select” commands that may include the waveform transfer command.

Finally, the Model 395 attempts to read the DSO data in the format specified in the “format” block.

---

### F.3.1.1 [id]

The “id” block identifies the make and model of the DSO. The Model 395 uses items in this block, but the Model 395 does not send these items to the DSO as commands. The “id” block uses these commands:

```
version;  
id;  
make;  
model.
```

#### **version = number**

The “number” permits the programmer of the DSO driver to reference driver versions (usually starting a 1.0). Version is not used by the Model 395. For example:

version = “1.6” identifies the driver as version 1.6.

#### **id = string**

The “id” string identifies the make and model number of the DSO which will be displayed on the DSO screen’s DSO listing. The string can contain up to 15 characters including spaces.

For example:

id = “LeCroy 94XX” places “LeCroy 94XX” in the Model 395 DSO listing.

#### **make = string**

The “make” string allows the DSO driver programmer to reference the make or manufacturer of the DSO. Make is not used by the Model 395.

For example:

make = “LeCroy” identifies LeCroy as the manufacturer of the DSO.

#### **model = string**

The “model” string allows the DSO driver programmer to reference the actual model of the DSO used when writing the driver. Model is optional and not used by the Model 395. For example: “model = 9420” identifies the LeCroy 9420 as the DSO used when the driver was written.

[id] Example Summary:

```
[id]  
version = 1.6  
id = LeCroy 94XX  
make = LeCroy  
model = 9420
```

### F.3.1.2 [setup *n*]

The “setup” block commands setup the DSO and Model 395. The DSO driver file can contain up to two setup blocks that are identified by the number *n* (1 or 2). If only one “setup” block is used, it must include a number [setup 1]. The “setup” block uses these commands:

```
timeout  
send
```

#### **timeout=string**

This string sets the GPIB handshake timeout in seconds. The “timeout” string allows the programmer to set the time the Model 395 wait for data from the DSO before disconnecting or timing out. While there is no upper limit to the timeout, the practical limit is 10 seconds.

For example:

timeout = “0.5” sets the GPIB handshake timeout to 0.5 seconds.



---

### ***send=string***

This string sends commands to the DSO that define the DSO waveform transfer format. Maximum string size is 256 ASCII characters. To send a carriage return, use "\r;" linefeed is "\n."

To determine the proper commands, consult the DSO manual for the GPIB or the SCPI commands that control binary waveform transfer from the DSO to external devices. The Model 395 receives data as straight binary data or as defined by the IEEE-488.2 Definite Length Arbitrary Block Data format (paragraph 5.8) and expects the data in the format defined by the [format] block commands.

For example: the Tektronix 2430 would use these commands:

```
send = "data encdg:rpbinary"
      which selects the right justified positive integer format.
```

The Gould 1624 would use these commands:

```
send = "WIND=0, 1023\n"
send = "BSLO\n"
send = "NB=BIN\n"
      which selects infinite length binary transfer of 1024 bytes. Note the "\n"
      linefeed is included.
```

### **F.3.1.3 [select n]**

The "select" block commands select the DSO waveform source. The DSO driver file can contain up to 20 "select" blocks. Each "select" block is identified by the number *n* (1 through 20). Each "select" block must contain at least one display message and a list of one or more commands. If only one "setup" block is used, it must include a number [setup 1]. The "setup" block uses these commands:

```
display
send
```

### ***display=string***

This command is used by the Model 395 to identify the DSO waveform source. This item is listed under the DSO setup screen. Each string can contain up to 15 characters commands. The string will be displayed on the Model 395 screen.

For example: display = "CHANNEL 1" displays CHANNEL 1 on the DSO setup screen.

### ***send=string***

This string sends commands to the DSO that define the waveform source. Maximum string size is 256 ASCII characters. To send a carriage return, use "\r;" linefeed is "\n." For example: send = "DATA SOURCE: CH1" sends the command at do upload that selects channel 1 as the waveform source.

[select] Example Summary:

```
[select 1]
display = "CHANNEL 1"
send = "DATA SOURCE: CH1"
```

---

### F.3.1.4 [format]

The “format” block defines how the Model 395 expects to receive the data from the DSO. If an item is left out of the “format” block, the Model 395 uses the default value (displayed first on the list in **bold**). Every DSO driver file must contain a “format” block.

The “format” command contains these commands:

order  
size  
dsize  
dsign  
count\_type  
count\_size  
btype  
format

#### **order**

This item defines the order in which the Model 395 expects the waveform data: **MSB** or **LSB**. “order = **MSB**” most significant byte first; “order = **LSB**” least significant byte first.

#### **size**

This item defines the number of bytes per data point: **1** or **2**. “size = **1**” selects 1 byte per data point; “size = **2**” selects 2 bytes per data point.

#### **dsize**

This item defines the data size. “dsize = **8**,” selects 8 bit data; “dsize = **12**,” selects 12 bit data; or “dsize = **16**,” selects 16 bit data.

#### **dsign**

This item defines signed or unsigned data. “dsign = **0**” selects unsigned data. “dsign = **1**” selects signed 2’s complement data

#### **count\_type**

This item determines the type of data found in the <count> field. There are three count\_types:

- 1 There is no <count> field, and the count is fixed. The expected number of data bytes to be received is specified by the count\_size parameter.
- 4 <count>, a binary number (NUM), represents the number of bytes remaining in the transfer. To find the number of data points in the waveform, the calculation is:  
(NUM - any <skip=n> fields between <count> and <end>) ÷ size  
The number of bytes in NUM is specified by count\_size parameter (should be 1 or 2). If count\_size = 2, then the “order” specifies the msb position.
- 5 <count> is specified in the 488.2 Definite Length Arbitrary Block Response Format (paragraph 5.8). <count> is specified in a series of bytes as follows:  
# Signifies the start of the count field.  
numdigs An ASCII digit specifies how many digits in the count  
dig1 ... digN The actual digits for the count, in ASCII format

Example

#3256 means count = 256.

The derived count number (example = 256) represents the number of bytes “remaining in the transfer”. See count\_type 4 for a description of the relationship between: “remaining bytes in transfer” and “number of points in waveform.”

---

### **count\_size = n**

If count\_type 1 is defined, the count\_size number, n, specifies the expected number of data bytes received by the Model 395. The data order (MSB or LSB) is defined by "order." The Model 395 accepts data less than the specified number providing the data is terminated with EOI.

If count\_type 4 is selected, the count\_size number, n, defines the binary count data (1 byte or 2 bytes) in DSO waveform header.

### **btype = n**

N = 0 or 1. "btype = 0" data is not buffered during GPIB data transfer. "btype = 1" uses direct buffering during data transfer. Currently used only by Yokogawa DSOs.

### **Format**

This item is a list of specified data elements expected from the DSO in the order listed. All bytes sent from the DSO must be accounted for.

The acceptable data elements are :

<skip = n>	skip n number of bytes
<skipuntil = "string">	skip until string encountered
<"string">	read in specific string of characters
<count>	defined by count_type and count_size
<data>	data bytes themselves
<end>	specifies the end of transmission, may be by EOI

### **F.3.1.5 [Help]**

Help allows the programmer of the driver to write operator instructions. The Model 395 displays these instructions on its screen when the "Help" key is pressed. Use the help block to display any information or instructions (waveform capture on DSO, cable connections, GPIB address selection, etc.).

When typing text for the help screen, keep in mind the Model 395 displays 20 characters per line. Thus, the Model 395 wraps characters after every 20th character (including spaces). Therefore, a return should be inserted before the 20th character to preserve whole words.

For example:

```
[help]
{DL1200 Help}
This is help
information for the
Yokogawa DL1200 DSO
driver. To
download a waveform
from the scope:
```

## **F.4 LOADING THE DSO DRIVER**

Load a DSO driver into the Model 395 by using the SCPI command:

```
MMEMory:DLOad:DSO <DSO_name>,<block>
```

<DSO\_name> A 1 to 8 character name to give the driver while it resides in the Model 395. Typically, the chosen name identifies the DSO file on the MMEM:CAT? query, and the name is used to later remove the driver from memory with the MMEMory:DELeTe:DSO command.

---

<block> An IEEE 488.2 Definite Length Arbitrary Block Data paragraph 5.8. For a DSO driver, the size portion of the block header is the number of bytes in the text definition to be downloaded.

The Model 395 can store as many additional DSO driver files as the unit's memory will allow.

Once loaded into the Model 395, a DSO driver remains until either the remote commands "MMEMory:DELEte:DSO <name>" or "MMEMory:INITialize" are sent. Also, press the front panel RESET key and select "delete setup, DSOs... ."

## F.5 DSO DRIVER EXAMPLES

Following are examples of DSO Driver files. Use these examples as references when creating drivers for your DSO. Where possible, the example files have been annotated

### Example 1

The example illustrates the DSO driver for the Tek2430 DSO driver which downloads waveforms from the Tektronix 2430 DSO to Wavetek Model 395.

[id]

version = 1.0	Identifies driver version 1.0.
make = "Tektronix"	Reference DSO make: Tektronix.
model= "2430"	Reference DSO model: 2430.
id = "Tek 2430 V1.0"	Displayed on DSO screen: "Tek 2430 V1.0."

[setup 1]

timeout = 0.5	Set GPIB handshake timeout to 0.5 seconds.
send = "DATA ENCDG:RPBINARY"	Sends to DSO GPIB commands to selects binary right justified positive integer data format.

[select 1]

display = "CHANNEL 1"	This string is displayed in the 395 DSO setup list.
send = "DATA SOURCE: CH1"	If selected, at "do upload" these commands are sent to select the waveform source.

[select 2]

display = "CHANNEL 2"	This string is displayed in the 395 DSO setup list.
send = "DATA source: CH2"	If selected, at "do upload" these commands are sent to select the waveform source.

[select 3]

display = "REFERENCE 1"	This string is displayed in the 395 DSO setup list.
send = "DATA SOURCE: REF1"	If selected, at "do upload" these commands are sent to select the waveform source.

[select 4]

display = "REFERENCE 2"	This string is displayed in the 395 DSO setup list.
send = "DATA SOURCE: REF2"	If selected, at "do upload" these commands are sent to select the waveform source.

[select 5]

display = "REFERENCE 3"	This string is displayed in the 395 DSO setup list.
send = "DATA SOURCE: REF3"	If selected, at "do upload" these commands are sent to select the waveform source.

---

<pre>[select 6]   display = "REFERENCE 4"   send = "DATA SOURCE: REF4"</pre>	<p>This string is displayed in the 395 DSO setup list.</p> <p>If selected, at "do upload" these commands are sent to select the waveform source.</p>
<pre>[setup 2]   send = "WAVfrm?"</pre>	<p>At "do upload" this command transfers the waveform from the DSO to Model 395.</p>
<pre>[format] size= 1 dsize = 8 dsign = 0 count_type = 4 count_size = 2 order = msb format= &lt;skipunti l= "%"&gt;&lt;count&gt;&lt;data&gt;&lt;skip=1&gt;</pre>	<p>Model 395 expects 1 byte/point.</p> <p>Model 395 expects 8 bit data.</p> <p>Model 395 expects unsigned data.</p> <p>Count = remaining bytes in transfer.</p> <p>Defines the count size header as 2 bytes.</p> <p>Model 395 expects MSB first.</p> <p>Model 395 skips data until "%." Reads the count and data bytes, and skips the last byte.</p>

## Example 2

The example illustrates the DSO driver for the Tektronix 11402 DSO driver which downloads waveforms from the Tektronix 11402 DSO to Wavetek Model 395.

<pre>[id]   version = 1.0   make = "Tektronix"   model= "11402"   id = "Tek 11402 V1.0"</pre>	<p>Identifies driver version 1.0.</p> <p>Reference DSO make: Tektronix.</p> <p>Reference DSO model: 11402.</p> <p>Displayed on DSO screen: "Tek 11402 V1.0."</p>
<pre>[setup 1]   timeout = 0.5   send = "ENCDG WAVFRM:BINARY"</pre>	<p>Set GPIB handshake timeout to 0.5 seconds.</p> <p>Sends to DSO GPIB commands to selects binary right justified positive integer data format.</p>
<pre>  send = "BYT.OR MSB"</pre>	<p>Sends byte order command: MSB first.</p>
<pre>[select 1]   display = "STORAGE 1"   send = "OUTPUT STO1"</pre>	<p>This string is displayed in the 395 DSO setup list.</p> <p>If selected, at "do upload" these commands are sent to select the waveform source.</p>
<pre>[select 2]   display = "STORAGE 2"   send = "OUTPUT STO2"</pre>	<p>This string is displayed in the 395 DSO setup list.</p> <p>If selected, at "do upload" these commands are sent to select the waveform source.</p>
<pre>[select 3]   display = "STORAGE 3"   send = "OUTPUT STO3"</pre>	<p>This string is displayed in the 395 DSO setup list.</p>
<pre>[select 4]   display = "STORAGE 4"   send = "OUTPUT STO4"</pre>	<p>This string is displayed in the 395 DSO setup list.</p>

---

<pre>[setup 2]   send = "CURVE?"</pre>	<p>At "do upload" this command transfers the waveform from the DSO to Model 395.</p>
<pre>[format]   size = 2   dsize = 16   dsign = 1    count_type = 4   count_size = 2   order = msb   format = &lt;skipuntil="CURVE %"&gt;&lt;count&gt;&lt;data&gt;&lt;skip=1&gt;</pre>	<p>Model 395 expects 2 bytes/point.  Model 395 expects 16-bit data.  Model 395 expects signed 2's complement data.  Count = remaining bytes in transfer.  count is 2 bytes wide  Model 395 expects MSB first.  Model 395 skips data until "CURVE %."  Reads the count and data bytes, and skips the last byte.</p>

### Example 3

The example illustrates the DSO driver for the HP54602 DSO driver which downloads waveforms from the Hewlett Packard HP54602 DSO to Wavetek Model 395.

<pre>[id]   version = 1.7   make = "Hewlett Packard"   model = "54602"   id = "HP 54602 V1.0"</pre>	<p>Identifies driver version 1.7.  Reference DSO make: Hewlett Packard.  Reference DSO model: 54602.  Displayed on DSO screen: "HP 54602 V1.0."</p>
<pre>[setup 1]   timeout = 0.5   send = "WAVEFORM:FORMAT BYTE"</pre>	<p>Set GPIB handshake timeout to 0.5 seconds.  Sends to DSO GPIB commands to select IEEE-488.2 Definite Length Arbitrary Block Data format.</p>
<pre>[select 1]   display = "CHANNEL 1"   send = "WAVEFORM:SOURCE CHAN1"</pre>	<p>This string is displayed in the 395 DSO setup list.  If selected, at "do upload" these commands are sent to select the waveform source.</p>
<pre>[select 2]   display = "CHANNEL 2"   send = "WAVEFORM:SOURCE CHAN2"</pre>	<p>This string is displayed in the 395 DSO setup list.  If selected, at "do upload" these commands are sent to select the waveform source.</p>
<pre>[select 3]   display = "CHANNEL 3"   send = "WAVEFORM:SOURCE CHAN3"</pre>	<p>This string is displayed in the 395 DSO setup list.  If selected, at "do upload" these commands are sent to select the waveform source.</p>
<pre>[select 4]   display = "CHANNEL 4"   send = "WAVEFORM:SOURCE CHAN4"</pre>	<p>This string is displayed in the 395 DSO setup list.  If selected, at "do upload" these commands are sent to select the waveform source.</p>
<pre>[setup 2]   send = "WAVEFORM:DATA?"</pre>	<p>At "do upload" this command transfers the waveform from the DSO to Model 395.</p>

---

[format]

size = 1  
dsize = 8  
dsign = 0  
count\_type = 5

order = msb  
format = <count><data><skip=1>

Model 395 expects 1 bit/point.  
Model 395 expects 8-bit data.  
Model 395 expects unsigned data.  
The Model 395 expects the data in 488.2  
Definite Length Arbitrary Block Data  
format.

Model 395 expects MSB first.

Model 395 reads the count bytes and data  
bytes, and skips the last byte.

## Example 4

The example illustrate the DSO driver for the LeCroy 9420/24/50 series DSOs to Wavetek Model 395. This driver supports the 'hi' resolution -> 16 bit transfers for all waveforms.

[id]

version = 2.3  
make = "LeCroy"  
model = "9420"  
id = "LeCroy 94xx"

Identifies driver version 2.3.  
Reference DSO make: LeCroy.  
Reference DSO model: 9420.  
Displayed on DSO screen: "LeCroy 94xx."

[setup 1]

timeout = 0.5  
send = "CORD HI"

Set GPIB handshake timeout to 0.5 seconds.  
Sends to DSO GPIB commands to select  
IEEE-488.2 Definite Length Arbitrary  
Block Data format.

send = "CFMT DEF9,WORD,BIN"

[select 1]

display = "MemC All pts"  
send = "WFSU SP,0,NP,0,FP,0,SN,0"  
send = "MC:WF? DAT1"

This string is displayed in the 395 DSO  
setup list.  
If selected, at "do upload" these commands  
are sent to select the waveform source.  
If selected, at "do upload" this command  
transfers the waveform from the DSO to  
Model 395.

[select 2]

display = "MemC 5000pts"  
send = "WFSU SP,0,NP,5000,FP,0,SN,0"  
send = "MC:WF? DAT1"

This string is displayed in the 395's DSO  
setup list.  
If selected, at "do upload" these commands  
are sent to select the waveform source.  
If selected, at "do upload" this command  
transfers the waveform from the DSO to  
Model 395.

[select 3]

display = "MemC 10000pts"  
send = "WFSU SP,0,NP,10000,FP,0,SN,0"  
send = "MC:WF? DAT1"

This string is displayed in the 395's DSO  
setup list.  
If selected, at "do upload" these commands  
are sent to select the waveform source.  
If selected, at "do upload" this command  
transfers the waveform from the DSO to  
Model 395.

---

[select 4]	
display = "MemC 2000pts"	This string is displayed in the 395's DSO setup list.
send = "WFSU SP,0,NP,20000,FP,0,SN,0"	If selected, at "do upload" these commands are sent to select the waveform source.
send = "MC:WF? DAT1"	If selected, at "do upload" this command transfers the waveform from the DSO to Model 395.
[select 5]	
display = "MemD 5000pts"	This string is displayed in the 395's DSO setup list.
send = "WFSU SP,0,NP,5000,FP,0,SN,0"	If selected, at "do upload" these commands are sent to select the waveform source.
send = "MD:WF? DAT1"	If selected, at "do upload" this command transfers the waveform from the DSO to Model 395.
[select 6]	
display = "MemD 10000pts"	This string is displayed in the 395's DSO setup list.
send = "WFSU SP,0,NP,10000,FP,0,SN,0"	
send = "MD:WF? DAT1"	If selected, at "do upload" this command transfers the waveform from the DSO to Model 395.
[select 7]	
display = "MemD 20000pts"	This string is displayed in the 395 DSO setup list.
send = "WFSU SP,0,NP,20000,FP,0,SN,0"	If selected, at "do upload" these commands are sent to select the waveform source.
send = "MD:WF? DAT1"	If selected, at "do upload" this command transfers the waveform from the DSO to Model 395.
[select 8]	
display = "MemD All pts"	This string is displayed in the 395 DSO setup list.
send = "WFSU SP,0,NP,0,FP,0,SN,0"	If selected, at "do upload" these commands are sent to select the waveform source.
send = "MD:WF? DAT1"	If selected, at "do upload" this command transfers the waveform from the DSO to Model 395.
[format]	
size = 2	Model 395 expects 2 bytes/point.
dsize = 16	Model 395 expects 16-bit data.
dsign = 1	Model 395 expects signed 2's complement data.
count_type = 5	The Model 395 expects the data in 488.2 Definite Length Arbitrary Block Data format.
order= msb	Model 395 expects MSB first.
format= <count><data>	Model 395 reads the count bytes and data bytes.



### G.1 INTRODUCTION

This appendix consists of two parts: the performance verification and the alignment procedures. Use the performance verification procedure to check the Model 395 against its published specifications. Then, if needed, use the alignment procedure to make adjustments to ensure the unit meets specifications.

### G.2 PERFORMANCE VERIFICATION PROCEDURE

#### G.2.1 Standard Test Equipment

The following test equipment (or test equipment of equivalent specification) is recommended for verification of Model 395 specifications.

Description	Model	Critical Specs.
Signal Sources:	Wavetek Models 650 & 91	10 MHz, 0.8 Vp-p, sine 1 kHz, 20 Vp-p, triangle 600 Hz, 10 Vp-p, sine, 0 5 MHz, 10 Vp-p, square
Frequency Counter:	Wavetek 900	>10 MHz, 8 digit, <100 ppm Accuracy
Digital Multimeter:	Datron Model 1062	4-1/2 digit, 0.25% Accuracy
Distortion Analyzer:	HP Model 8903E	100 kHz, <0.01% Accuracy
Oscilloscope:	Tektronix Model 2465B	>200 MHz bandwidth
Spectrum Analyzer:	HP 70000	>200 MHz bandwidth
RF millivoltmeter:	Boonton Model 9200B	100 kHz - 40 MHz, 0.2% accuracy

#### G.2.2 Standard Test Conditions

The following test conditions are recommended when performing the verification procedure.

Temperature:	25°C +10°C
Humidity:	10% to 90%
Altitude:Sea Level	

#### G.2.3 Ref. Output Test

##### *Purpose*

Verify the accuracy of the internal 10 MHz reference oscillator and functionality of output driver circuits.

##### *Specification*

Parameter	Limit
Frequency	10 MHz $\pm$ 30 ppm
TTL high level	>1.5 V into 50
TTL low level	TTL level

##### *Setup and Procedure*

Terminate Reference Out into 50 . Verify frequency and levels per the following table:

Parameter	Min.	Max.
10 MHz ref frequency	9,999,700 Hz	10,000,300 Hz
TTL upper level	1.5 V	3 V
TTL lower level	0.0 V	0.4 V

---

## G.2.4 Ref Input Test

### **Purpose**

Verify functionality of reference input, reference band-pass filter and reference detector.

### **Specification**

<b>Parameter</b>	<b>Limit</b>
Accepted frequency	10 MHz $\pm$ 5%
Rejected frequency	n/a
Signal level	1 Vp-p min

### **Setup and Procedure**

- 1) Connect 0.8 Vp-p, 10 MHz sine to Reference Input. Set Model 395 to 10 MHz sine wave output and monitor frequency of MAIN OUT.
- 2) Verify frequency at MAIN OUT for each reference input frequency in the table below:

<b>Ref Input Frequency</b>	<b>Min.</b>	<b>Max.</b>
10.5 MHz $\pm$ 0.1%	10,489,500 Hz	10,510,500 Hz
9.5 MHz $\pm$ 0.1%	9,490,500 Hz	9,509,500 Hz
15 MHz $\pm$ 1%	9,999,700 Hz	10,000,300 Hz
5 MHz $\pm$ 1%	9,999,700 Hz	10,000,300 Hz

## G.2.5 Trigger Input Level/Slope Test

### **Purpose**

Verify the accuracy and functionality of the trigger input circuits.

### **Specification**

<b>Parameter</b>	<b>Limit</b>
Trigger level	$\pm$ 300 mV

### **Setup and Procedure**

- 1) Set the Model 395 to gated mode, 1 MHz square wave; trigger source external, positive slope. Apply 20 Vp-p, 1 kHz triangle wave to Trigger Input. Triangle signal should have no dc offset and be accurate to 0.3%.
- 2) Set slope and level controls as indicated in the table below. Measure the frequency of the Main output. Make sure to use a gate time on the counter that will provide a stable reading to the accuracy required, since the measurement is being made on a gated signal.

<b>Level/Slope Program</b>	<b>Min.</b>	<b>Max.</b>
+8V, +slope	90 kHz	110 kHz
0V, +slope	490 kHz	510 kHz
-8V, +slope	890 kHz	910 kHz
-8V, -slope	90 kHz	110 kHz

## G.2.6 Sync Output Test

### **Purpose**

Verify waveform quality and level of the sync output.

### **Specification**

<b>Parameter</b>	<b>Limit</b>
Rise/fall time	<7 ns
High level	>2.0 V into 50
Low level	<0.4 V into 50

---

### Setup and Procedure

Set the Model 395 to 10 MHz sine wave output and Sync Out ON. Using a scope verify rise/fall time and upper/lower levels of the SYNC OUT according to the table below:

Parameter	Min.	Max.
Rise time	n/a	7 ns
Fall time	n/a	7 ns
High level	2.0 V	3.5 V
Low level	0.0 V	0.4 V

## G.2.7 Horizontal Sweep Output Test

### Purpose

Verify functionality of the sweep output driver circuits.

### Specification

Parameter	Limit
Low level	0V $\pm$ 0.5V
High level	10V $\pm$ 0.5V
Impedance	1 k $\pm$ 5%

### Setup and Procedure:

- 1) Set the unit to manual sweep with start and stop frequency limits of 1 kHz and 10 kHz
- 2). Set the manual frequency to 1 and 10 kHz respectively and measure the voltage at the sweep out (unterminated) according to the following table

Parameter	Min.	Max.
Lower level	-0.5 V	0.5 V
Upper level	9.5 V	10.5 V

## G.2.8 Summing Input Test

### Purpose

Verify performance of summing circuitry.

### Specification

Parameter	Limit
Sum In scale factor	0dB (/1) atten.
Bandwidth	>30 MHz

### Setup and Procedure

- 1) Select function DC , amplitude 10 Vp-p.
- 2) Turn the Sum Input on and inject a 600 Hz, 10 Vp-p sine wave from a 0 source. Measure the accuracy of the amplitude at the main out according to the following table.
- 3) Inject a 5 MHz, 10 Vp-p square wave from a 50 source. The square wave should have rise/fall times less than 6 ns and aberrations < 3%
- 4) Measure the rise/fall time and aberrations of the signal at the main out according to the following table:

<b>Parameter</b>	<b>Min.</b>	<b>Max.</b>
Amplitude	9.5 Vp-p	10.5 Vp-p
Rise time	n/a	12 ns
Fall time	n/a	12 ns
Aberrations	n/a	8 %

Note: rise/fall times are used to determine bandwidth using the relationship of rise/fall time =  $0.35 \div \text{BW}$

## G.2.9 AM Scale Factor Accuracy Test

### **Purpose**

Verify scale factor accuracy of AM circuits

### **Specification**

<b>Parameter</b>	<b>Limit</b>
AM scale factor	-1.25V $\pm$ 0.1V=0% +1.25V $\pm$ 0.1V=100%
SCM scale factor	-2.50 $\pm$ 0.2V=-100% +2.50V $\pm$ 0.2V=+100%
Modulation dist.	<1% to 100 kHz (80%)
Modulation BW	>100 kHz

### **Setup and Procedure**

- 1) Select 1 kHz sine output at 10 Vp-p.
- 2) Connect a dc voltage to the AM Input and measure the voltage at the main output according to the following table.

<b>Parameter</b>	<b>Min.</b>	<b>Max.</b>
AM,+1.25V.	3.3941 Vrms	3.677 Vrms
AM, -1.25V	n/a	0.1414 Vrms
SCM, +2.50V	3.3941 Vrms	3.677 Vrms
SCM, -2.50V	3.3941 Vrms	3.677 Vrms

## G.2.10 Clock Generator Test

### **Purpose**

Verify functionality of internal clock generation circuits.

### **Specification**

<b>Parameter</b>	<b>Limit</b>
Frequency accuracy	$\pm$ 100 ppm

### **Setup and Procedure**

Define a 10 point square waveform. Program waveform frequency and verify frequency accuracy according to the following table

<b>Waveform Frequency</b>	<b>Min.</b>	<b>Max.</b>
10 MHz	9,999,000 Hz	10,001,000 Hz
1 Hz	0.9999 Hz	1.0001 Hz

---

## G.2.11 Amplitude Accuracy Test

### **Purpose**

Verify accuracy and linearity of amplitude control and gain setting components.

### **Specification**

<b>Amplitude Range</b>	<b>Limit</b>
0.040 to 10.0 V <sub>p-p</sub>	$\pm(1\%+2mV_{p-p})$

### **Setup and Procedure**

Select function sine, 600 Hz. Measure voltage at Main Out terminated into 50  $\Omega$ . Termination should be accurate to 0.1%.

<b>Amplitude Program</b>	<b>Min.</b>	<b>Max.</b>
10.0 V <sub>p-p</sub>	3.4995 V <sub>rms</sub>	3.5716 V <sub>rms</sub>
-10.0 V <sub>p-p</sub>	3.4995 V <sub>rms</sub>	3.5716 V <sub>rms</sub>
5.01 V <sub>p-p</sub>	1.7529 V <sub>rms</sub>	1.7897 V <sub>rms</sub>
5.00 V <sub>p-p</sub>	1.7494 V <sub>rms</sub>	1.7862 V <sub>rms</sub>
2.50 V <sub>p-p</sub>	0.8743 V <sub>rms</sub>	0.8934 V <sub>rms</sub>
0.625 V <sub>p-p</sub>	0.2181 V <sub>rms</sub>	0.2239 V <sub>rms</sub>

## G.2.12 Amplitude Flatness Test

### **Purpose**

Verify the amplitude verses frequency calibration

### **Specification:**

<b>Frequency Range</b>	<b>Limit</b>
100 kHz	$\pm 0.2\text{dB}$
5 MHz	$\pm 0.5\text{dB}$
20 MHz	$\pm 1.0\text{dB}$
40 MHz	$\pm 1.5\text{dB}$

### **Setup and Procedure**

Select function sine, 1 kHz, 10 V<sub>p-p</sub> Measure voltage at Main Out terminated into 50  $\Omega$ . Note 1 kHz amplitude. Record amplitude variation at programmed frequencies relative to 1 kHz amplitude as indicated in the table below.

<b>Frequency Program</b>	<b>Min.</b>	<b>Max.</b>
1 kHz	n/a	reference value
100 kHz	-0.2 dBc	+0.2 dBc
5 MHz	-0.4 dBc	+0.4 dBc
15 MHz	-0.8 dBc	+0.8 dBc
20 MHz	-0.8 dBc	+0.8 dBc
40 MHz	-1.3 dBc	+1.3 dBc

---

## G.2.13 DC Offset Accuracy Test

### **Purpose**

Verify the DC offset accuracy

### **Specification**

<b>Parameter</b>	<b>Limit</b>
Offset accuracy	$\pm 1\% \pm 20 \text{ mV}$

### **Setup and Procedure**

Select function DC. Measure voltage at Main Out terminated into 50  $\Omega$ . Termination must be accurate to at least 0.25%.

<b>Offset Program</b>	<b>Min.</b>	<b>Max.</b>
+5.00 V	4.93 Vdc	5.07 Vdc
0.00 Vp-p	-0.02 Vdc	0.02 Vdc
-5.00 Vp-p	-5.07 Vdc	-4.93 Vdc

## G.2.14 Harmonic Distortion Test

### **Purpose**

Verify the sine waveform meets distortion specifications

### **Specification**

<b>Frequency Range</b>	<b>Limit</b>
100 kHz	THD <0.15%
5 MHz	no harmonic >-35 dBc
40 MHz	no harmonic >-22 dBc

### **Setup and Procedure**

Select function sine. Terminate Main Out into 50  $\Omega$ . Program frequencies and amplitudes according to the following table to verify distortion.

<b>Frequency</b>	<b>Min.</b>	<b>Max.</b>
100 kHz, 5.01 Vp-p	n/a	0.15 %
100 kHz, 10 Vp-p	n/a	0.15 %
5 MHz, 10 Vp-p	n/a	-35 dBc
30 MHz, 10 Vp-p	n/a	-22 dBc
40 MHz, 1% Vp-p	n/a	-22 dBc

Note: The instruments that are typically used to measure THD have the inherent problem that noise is integrated into the distortion measurement and gives erroneous readings. At measurement points at or below 1 kHz, the THD analyzer input filters provide a good method of high frequency noise rejection. At higher frequencies these filters can not be used as they would reduce the harmonic levels. If a Model 395 is exceeding the specified limit, then direct measurement of the harmonic levels will be required to determine if the problem is distortion or noise. While this is mainly a problem with low amplitude signals, it should be considered with all THD measurements.

---

## G.2.15 Square Waveform Quality

### **Purpose**

Verify Rise/Fall times and aberrations are within specification.

### **Specification:**

<b>Parameter</b>	<b>Limit</b>
Rise/fall time	<8 ns
Aberrations	<5% + 20 mV

### **Setup and Procedure**

Select function Square , 10 MHz. Program the following amplitudes and verify rise/fall and aberrations with the Main Out terminated into 50 according to the following table.

<b>Parameter</b>	<b>Min.</b>	<b>Max.</b>
Rise time at 10 Vp-p	n/a	8.0 ns
Fall time at 10 Vp-p	n/a	8.0 ns
Rise time at 5.01 Vp-p	n/a	8.0 ns
Fall time at 5.01 Vp-p	n/a	8.0 ns
Abr. at 10 Vp-p	n/a	520 mVp-p
Abr. at 5.01 Vp-p	n/a	270 mVp-p

## G.3 ALIGNMENT PROCEDURE

To perform the complete manual alignment procedure follow the steps listed below. During this procedure, the Model 395 automatically sets itself to the right conditions. "Adjustments" are made using the front panel knob.

### G.3.1 Equipment Required

The following list of test equipment is included for reference only. Substitution of any equipment is allowed as long as adequate measurement accuracy is maintained. Test equipment should always provide at least five times more accuracy than the specification of the parameter being tested. Only equipment that has been properly serviced and calibrated (traceable to NBS) according to the manufacturers specifications may be used for calibration.

<b>Test Equipment</b>	<b>Recommended Model</b>
Scope	Tektronix 2465A or equivalent.
Digital Voltmeter	Wavetek-Datron 1271 or equivalent.
Terminator	50 , 0.1%, 1 Watt

### G.3.2 Check Rise/Fall and Aberration Times

Before beginning the alignment procedure, verify the rise and fall time and aberrations of the 6 MHz square wave. Follow these steps:

Connect the Model 395 to the scope; see figure G-1.

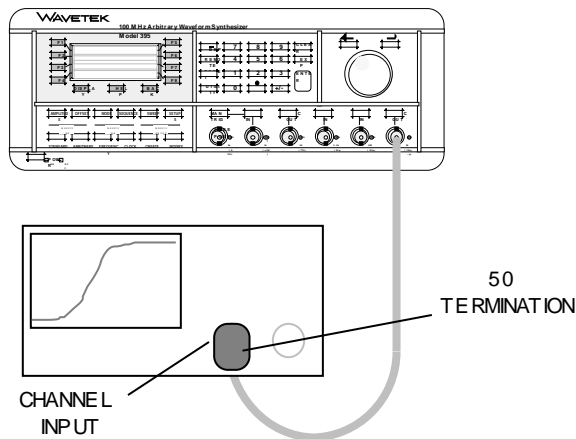
Set the Model 395 to the following conditions:

Frequency: 6 MHz (6 EXP 6 ENTER).

Amplitude: 8.0 Vp-p (select Vp-p, enter 8 ENTER).

Standard Waveform: select "Square."

Main Out: MAIN OUT, select "on."



**Figure G-1. Rise/Fall Test Setup**

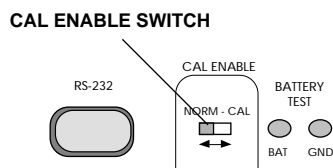
Set the scope to display one cycle of the 6 MHz square wave. Adjust the vertical level of the scope so the peak to peak level of the square wave fits between the 0% and 100% marks on the display of the scope.

Expand the expand time base on the scope to accurately read the rise/fall times between the 10% and 90% marks. The rise/fall times should be <7 ns. Verify the aberrations are less than 5% peak to peak.

If the rise/fall times and aberrations do not meet specifications, open the top cover and adjust C175 on the main board. Replace the cover.

**Before Beginning**

Before beginning this calibration procedure, remove the calibration sticker over the CAL ENABLE switch on the rear panel. Place the switch in the CAL position. See figure G-2.



**Figure G-2. Calibration Enable Switch**

**G.3.3 Alignment Procedure**

During this procedure, the Model 395 firmware internally sets the conditions for each calibration step. All adjustments are made using the front panel knob, and calibration data is stored in nonvolatile memory. At any time during the procedure, press the HELP key for information relative to the calibration screen. Calibration can be stopped at any time by selecting “stop” (F4).

**G.3.3.1 Starting**

Connect the Model 395 to the power source. Turn the power on, and allow the unit to warm up with covers installed at least 30 minutes under the normal operating environment.

Press the UTILITY key to display the Utility Menu.



- ◇ power-on settings ...
- ◇ system info ...
- ◇ calibration ...
- ◇ DSO upload ...

Press F3 to select “calibration.” The Model 395 displays the CALIBRATION screen:

- CALIBRATION MENU
- ◇ cal procedure ...
  - ◇ default cal ...
  - ◇ calibration: on

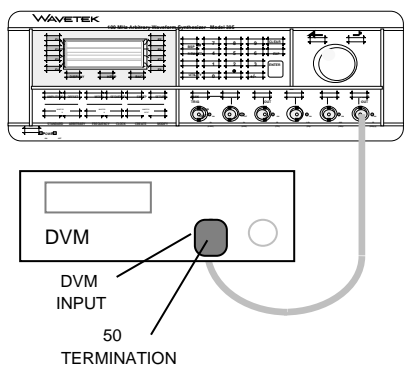
Select “Perform Calibration” ( F2).

### G.3.3.2 Amplitude Zero

The screen displays:

- 1: Amplitude Zero  
Main Out <20mVpp
- ◇ cal:202Ω                      prev ◇
  - ◇ stop                              next ◇

Connect the Model 395 to the DVM (figure G-3). Set the DVM to read AC volts. Adjust the knob on the Model 395 until the DVM reads 0 Vrms (<6 mVrms). When Amplitude Zero is OK, select “next,” F8, to advance to Reference Zero.

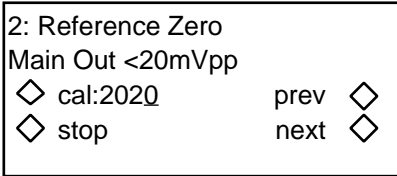


**Figure G-3. Model 395 - DVM Setup**

---

### G.3.3.3 Reference Zero

This screen displays:



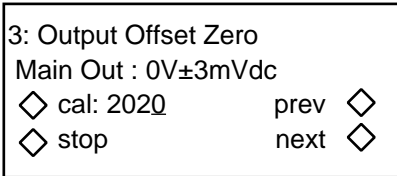
2: Reference Zero  
Main Out <20mVpp  
◇ cal:2020           prev ◇  
◇ stop                next ◇

Adjust the knob on the Model 395 until the DVM reads 0 Vrms (<6 mVrms).

When Reference Zero is OK, select “next,” F8, to advance to Output Offset Zero.

### G.3.3.4 Output Offset Zero

This screen displays:



3: Output Offset Zero  
Main Out : 0V±3mVdc  
◇ cal: 2020           prev ◇  
◇ stop                next ◇

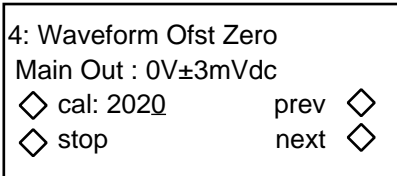
Set the DVM to DC volts.

Adjust the knob on the Model 395 until the DVM reads 0 Vdc ( $\pm 3$  mVdc).

When Output Offset Zero is OK, select “next,” F8, to advance to Waveform Offset Zero.

### G.3.3.4 Waveform Offset Zero

This screen displays:



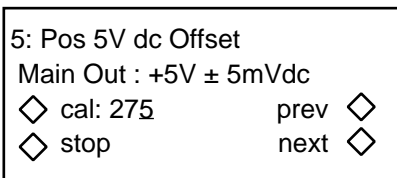
4: Waveform Ofst Zero  
Main Out : 0V±3mVdc  
◇ cal: 2020           prev ◇  
◇ stop                next ◇

Adjust the knob on the Model 395 until the DVM reads 0 Vdc ( $\pm 3$  mVdc).

When Waveform Offset Zero is OK, select “next”, F8, to advance to DC Offset, positive.

### G.3.3.5 DC Offset, Positive

This screen displays:



5: Pos 5V dc Offset  
Main Out : +5V ± 5mVdc  
◇ cal: 275            prev ◇  
◇ stop                next ◇

Adjust the knob on the Model 395 until the DVM reads  $5 \pm 0.005$  Vdc.

When positive DC offset is OK, select “next,” F8, to advance to DC Offset, negative.

---

### G.3.3.6 DC Offset, Negative

This screen displays:

6: Neg 5V dc Offset  
Main Out : -5V ± 5mVdc  
◇ cal: 383Ω            prev ◇  
◇ stop                    next ◇

Adjust the knob on the Model 395 until the DVM reads  $-5 \pm 0.005$  Vdc.

When negative DC offset is OK, select “next,” F8, to advance to Positive Peak, Normal Waveform.

### G.3.3.7 Positive Peak, Normal Waveform

This screen displays:

7: Ampl, +pk, normal  
Main Out : +4V ± 4mVdc  
◇ cal: 372Ω            prev ◇  
◇ stop                    next ◇

Adjust the knob on the Model 395 until the DVM reads  $+4 \pm 0.004$  Vdc.

When positive peak level is OK, select “next,” F8, to advance to negative peak, Normal Waveform.

### G.3.3.8 Negative Peak, Normal Waveform

This screen displays:

8: Ampl, -pk, normal  
Main Out : -4V ± 4mVdc  
◇ cal: 372Ω            prev ◇  
◇ stop                    next ◇

Adjust the knob on the Model 395 until the DVM reads  $-4 \pm 0.004$  Vdc.

When positive peak level is OK, select “next,” F8, to advance to Positive peak, Inverted Waveform.

### G.3.3.9 Positive Peak, Invert Waveform

This screen displays:

9: Ampl, +pk, invert  
Main Out : +4V ± 4mVdc  
◇ cal: 372Ω            prev ◇  
◇ stop                    next ◇

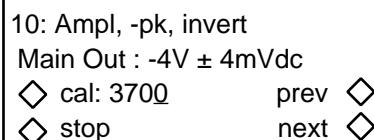
Adjust the knob on the Model 395 until the DVM reads  $+4 \pm 0.004$  Vdc.

When positive peak level is OK, select “next,” F8, to advance to negative peak, invert waveform.

---

### G.3.3.10 Negative Peak, Inverted Waveform

This screen displays:



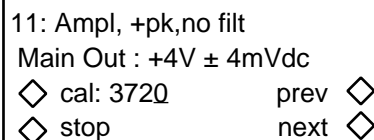
```
10: Ampl, -pk, invert
Main Out : -4V ± 4mVdc
◇ cal: 370Ω          prev ◇
◇ stop              next  ◇
```

Adjust the knob on the Model 395 until the DVM reads  $-4 \pm 0.004$  Vdc.

When positive peak level is OK, select “next,” F8, to advance to Positive peak, No Filter.

### G.3.3.11 Positive Peak, No Filter

This screen displays:



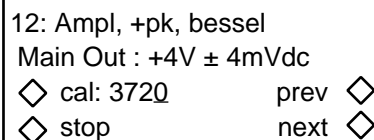
```
11: Ampl, +pk, no filt
Main Out : +4V ± 4mVdc
◇ cal: 372Ω          prev ◇
◇ stop              next  ◇
```

Adjust the knob on the Model 395 until the DVM reads  $+4 \pm 0.004$  Vdc.

When positive peak level is OK, select “next,” F8, to advance to Positive Peak, Bessel Filter.

### G.3.3.12 Positive Peak, Bessel Filter

This screen displays:



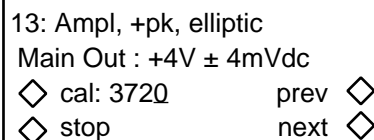
```
12: Ampl, +pk, bessel
Main Out : +4V ± 4mVdc
◇ cal: 372Ω          prev ◇
◇ stop              next  ◇
```

Adjust the knob on the Model 395 until the DVM reads  $+4 \pm 0.004$  Vdc.

When positive peak level is OK, select “next,” F8, to advance to Pos Peak, 40 MHz Ftr.

### G.3.3.13 Positive Peak, 40 MHz Filter

This screen displays:



```
13: Ampl, +pk, elliptic
Main Out : +4V ± 4mVdc
◇ cal: 372Ω          prev ◇
◇ stop              next  ◇
```

Adjust the knob on the Model 395 until the DVM reads  $+4 \pm 0.004$  Vdc.

When the positive peak is OK, select “next,” F8, to advance to Trigger Level, 0 Vdc

---

### G.3.3.14 Trigger Level, 0 Vdc

This screen displays:

14: Trig Level 0V  
Sync Out: 50%  $\pm$  2% sqr  
◇ cal: 202Ω            prev ◇  
◇ stop                    next ◇

Connect a 50  $\Omega$  cable from the MAIN OUT connector to the TRIG IN connector on the Model 395. Do not use a load.

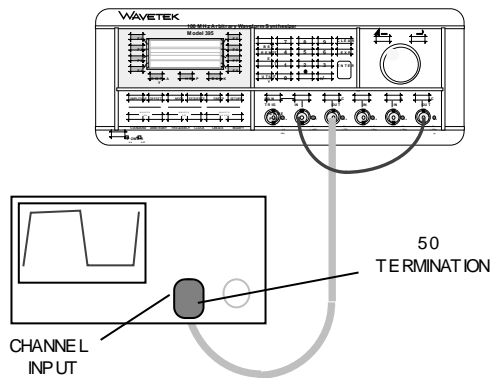
Connect the SYNC OUT from the Model 395 to the channel input on the scope. Terminate the cable with 50  $\Omega$  at the scope input.

Refer to figure G-4. Set the scope to display one cycle of the Sync Output.

Adjust the knob on the Model 395 until the Sync Output is at 50%  $\pm$  2% symmetry (48% to 52%). See figure G-5.

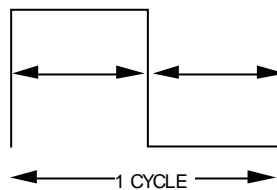
When symmetry is OK, select “next,” F8, to advance to Trigger Level, 3 V

---



**Figure G-4. Trig Level Setup**

---

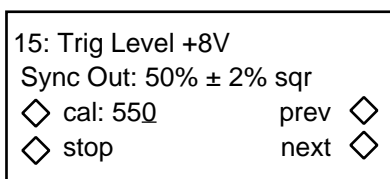


**Figure G-5. Symmetry**

---

### G.3.3.15 Trigger Level, +8Vdc

This screen displays:



15: Trig Level +8V  
Sync Out: 50% ± 2% sqr  
◇ cal: 55Ω            prev ◇  
◇ stop                next ◇

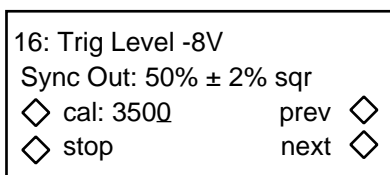
Refer to figure G-4. Set the scope to display one cycle of the Sync Output.

Adjust the knob on the Model 395 until the Sync Output is at 50% ± 2% symmetry (48% to 52%). See figure G-5.

When symmetry is OK, select “next,” F8, to advance to Trigger Level, 8V.

### G.3.3.16 Trigger Level, -8Vdc

This screen displays:



16: Trig Level -8V  
Sync Out: 50% ± 2% sqr  
◇ cal: 350Ω            prev ◇  
◇ stop                next ◇

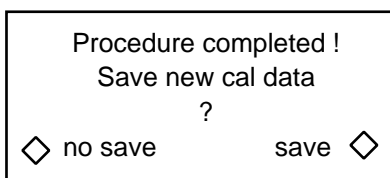
Refer to figure G-4. Set the scope to display one cycle of the Sync Output.

Adjust the knob on the Model 395 until the Sync Output is at 50% ± 2% symmetry (48% to 52%). See figure G-5.

When symmetry is OK, select “next,” F8, to advance to “Cals Change ...”

### G.3.3.17 Procedure Completed

The Procedures Completed screen appears when changes were made during the calibration procedure. If no changes were made, the Mode 395 returns to the Utilities screen.



Procedure completed !  
Save new cal data  
?  
◇ no save            save ◇

Select “save,” F8, to store calibration data to the Model 395 nonvolatile memory, or select “no save,” F4, to cancel the last calibration and to keep the previous calibration data.

The procedure is now complete , and the Model 395 returns to the Utility screen.

## G.3.4 Finishing Up

After completing the Alignment Procedure, place the Cal Enable switch back to the NORM position. See figure G-2. Place a Calibration Sticker over the Cal Enable switch if necessary.

***United States***

9045 Balboa Avenue  
San Diego  
CA 92123  
U.S.A.

Tel: (1) 800-874-4835  
Fax: (1) 858-450-0325

***United Kingdom***

Hurricane Way  
Norwich  
Norfolk  
NR6 6JB  
U.K.

Tel: (44) 1603-256600  
Fax: (44) 1603-256688

***[www.wavetek-datron.com](http://www.wavetek-datron.com)***

