

CPD-110GS/110EST

SERVICE MANUAL

REVISED

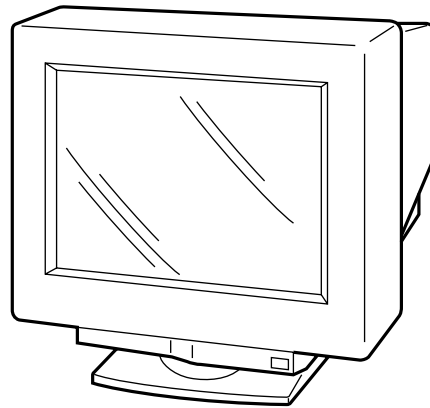

CPD-110GS

US Model

Canadian Model

Chassis No. SCC-L27A-A

CPD-110EST

AEP Model

Chassis No. SCC-L27B-A

X-110 CHASSIS

SPECIFICATIONS

CRT	0.25 mm aperture grille pitch 15 inches measured diagonally 90-degree deflection
Viewable image size	Approx. 285 × 214 mm (w/h) (11 1/4 × 8 1/2 inches) 14.0" viewing image
Resolution	Horizontal: Max. 1280 dots Vertical: Max. 1024 lines
Standard image area	Approx. 270 × 202 mm (w/h) (10 3/4 × 8 inches)
Deflection frequency*	Horizontal: 30 to 70 kHz Vertical: 48 to 120 Hz
AC input voltage/current	100 to 240 V, 50 – 60 Hz, 1.6 – 0.8 A
Power consumption	Max. 105 W
Dimensions	Approx. 368 × 393 × 389 mm (w/h/d) (14 1/2 × 15 1/2 × 15 3/8 inches)
Mass	Approx. 14 kg (30 lb 14 oz)
Plug and Play	DDC1/DDC2B
Supplied accessories	See page 6

* Recommended horizontal and vertical timing condition

- Horizontal sync width should be more than 1.0 µsec.
- Horizontal blanking width should be more than 3.6 µsec.
- Vertical blanking width should be more than 500 µsec.

Design and specifications are subject to change without notice.

TRINITRON® COLOR COMPUTER DISPLAY
SONY®



DIAGNOSIS

Failure	Power LED
HV or H STOP or +B Failure	Blink Amber (On 0.5 sec, Off 0.5 sec)
V Stop Failure	Blink Amber (On 1.5 sec, Off 0.5 sec)
Aging/Self-Test	Blink Amber (On 0.5 sec, Off 0.5 sec) Blink Green (On 0.5 sec, Off 0.5 sec)
Out of Range	On Green (OSD Indication)
No Input Signal	On Green (OSD Indication)

TIMING SPECIFICATION

PRIMARY MODE MODE AT PRODUCTION	MODE 1	MODE 2	MODE 3	MODE 4	MODE 5	MODE 6	PRIMARY MODE 7	MODE 8	MODE 9
RESOLUTION	640 X 480	640 X 480	720 X 400	800 X 600	800 X 600	832 X 624	1024 X 768	1024 X 768	1280 X 1024
CLOCK	25.175 MHZ	36.000 MHZ	28.322 MHZ	49.500 MHZ	56.250 MHZ	57.283 MHZ	78.750 MHZ	94.500 MHZ	108.000 MHZ
— HORIZONTAL —									
H-FREQ	31.469 kHz	43.269 kHz	31.469 kHz	46.875 kHz	53.674 kHz	49.725 kHz	60.024 kHz	68.677 kHz	63.981 kHz
	usec	usec	usec	usec	usec	usec	usec	usec	usec
H. TOTAL	31.778	23.111	31.777	21.333	18.631	20.111	16.660	14.561	15.630
H. BLK	6.356	5.333	6.355	5.172	4.409	5.586	3.657	3.725	3.778
H. FP	0.636	1.556	0.636	0.323	0.569	0.559	0.203	0.508	0.444
H. SYNC	3.813	1.556	3.813	1.616	1.138	1.117	1.219	1.016	1.037
H. BP	1.907	2.222	1.907	3.232	2.702	3.910	2.235	2.201	2.296
H. ACTIV	25.422	17.778	25.422	16.162	14.222	14.524	13.003	10.836	11.852
— VERTICAL —									
V. FREQ(HZ)	59.940 Hz	85.008 Hz	70.087 Hz	75.000 Hz	85.061 Hz	74.550 Hz	75.030 Hz	84.997 Hz	60.020 Hz
	lines	lines	lines	lines	lines	lines	lines	lines	lines
V. TOTAL	525	509	449	625	631	667	800	808	1066
V. BLK	45	29	49	25	31	43	32	40	42
V. FP	10	1	12	1	1	1	1	1	1
V. SYNC	2	3	2	3	3	3	3	3	3
V. BP	33	25	35	21	27	39	28	36	38
V. ACTIV	480	480	400	600	600	624	768	768	1024
— SYNC —									
INT(G)	NO	NO	NO	NO	NO	NO	NO	NO	NO
EXT(H/V)/POLARITY	YES -/-	YES -/-	YES -/+	YES +/+	YES +/+	YES -/-	YES +/+	YES +/+	YES +/+
EXT(CS)/POLARITY	NO	NO	NO	NO	NO	NO	NO	NO	NO
INT/NON INT	NON INT	NON INT	NON INT	NON INT	NON INT	NON INT	NON INT	NON INT	NON INT

98.12.10 VER.

Power saving function

This monitor meets the power-saving guidelines set by VESA, ENERGY STAR, and NUTEK. If the monitor is connected to a computer or video graphics board that is DPMS (Display Power Management Signaling) compliant, the monitor will automatically reduce power consumption in three stages as shown below.

* When your computer enters the "active off" mode, the input signal is cut and NO INPUT SIGNAL appears on the screen. After 20 seconds, the monitor enters the power saving mode.

Power mode	Power consumption	⏻ (power) indicator
normal operation	≤ 110 W (CPD-210GS) ≤ 105 W (CPD-110GS)	green
1 standby	≤ 15 W	green and orange alternate
2 suspend	≤ 15 W	green and orange alternate
3 active off*	≤ 5 W	orange
power off	0 W	off

After correcting the original service problem, perform the following safety checks before releasing the set to the customer:

1. Check the area of your repair for unsoldered or poorly-soldered connections. Check the entire board surface for solder splashes and bridges.
2. Check the interboard wiring to ensure that no wires are “pinched” or contact high-wattage resistors.
3. Check that all control knobs, shields, covers, ground straps, and mounting hardware have been replaced. Be absolutely certain that you have replaced all the insulators.
4. Look for unauthorized replacement parts, particularly transistors, that were installed during a previous repair. Point them out to the customer and recommend their replacement.
5. Look for parts which, though functioning, show obvious signs of deterioration. Point them out to the customer and recommend their replacement.
6. Check the line cords for cracks and abrasion. Recommend the replacement of any such line cord to the customer.
7. Check the B+ and HV to see if they are specified values. Make sure your instruments are accurate; be suspicious of your HV meter if sets always have low HV.
8. Check the antenna terminals, metal trim, “metallized” knobs, screws, and all other exposed metal parts for AC Leakage. Check leakage as described below.

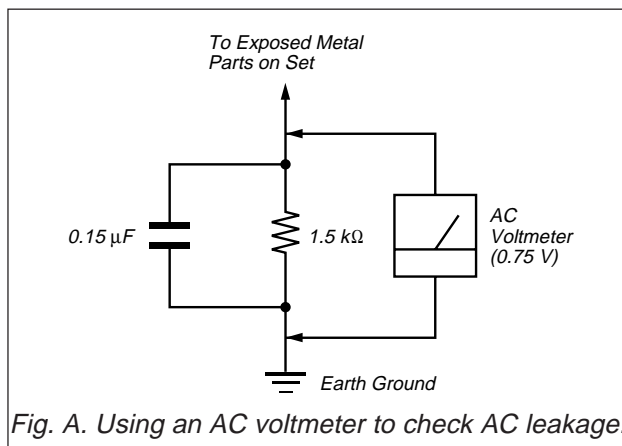

Fig. A. Using an AC voltmeter to check AC leakage.

LEAKAGE TEST

The AC leakage from any exposed metal part to earth ground and from all exposed metal parts to any exposed metal part having a return to chassis, must not exceed 0.5 mA (500 microamperes).

Leakage current can be measured by any one of three methods.

1. A commercial leakage tester, such as the Simpson 229 or RCA WT-540A. Follow the manufacturers' instructions to use these instruments.
2. A battery-operated AC milliammeter. The Data Precision 245 digital multimeter is suitable for this job.
3. Measuring the voltage drop across a resistor by means of a VOM or battery-operated AC voltmeter. The “limit” indication is 0.75 V, so analog meters must have an accurate low-voltage scale. The Simpson 250 and Sanwa SH-63Trd are examples of a passive VOMs that are suitable. Nearly all battery operated digital multimeters that have a 2 V AC range are suitable. (See Fig. A)

WARNING!!

NEVER TURN ON THE POWER IN A CONDITION IN WHICH THE DEGAUSS COIL HAS BEEN REMOVED.

SAFETY-RELATED COMPONENT WARNING!!
COMPONENTS IDENTIFIED BY SHADING AND MARK \triangle ON THE SCHEMATIC DIAGRAMS, EXPLODED VIEWS AND IN THE PARTS LIST ARE CRITICAL FOR SAFE OPERATION. REPLACE THESE COMPONENTS WITH SONY PARTS WHOSE PART NUMBERS APPEAR AS SHOWN IN THIS MANUAL OR IN SUPPLEMENTS PUBLISHED BY SONY. CIRCUIT ADJUSTMENTS THAT ARE CRITICAL FOR SAFE OPERATION ARE IDENTIFIED IN THIS MANUAL. FOLLOW THESE PROCEDURES WHENEVER CRITICAL COMPONENTS ARE REPLACED OR IMPROPER OPERATION IS SUSPECTED.

AVERTISSEMENT!!

NE JAMAIS METTRE SOUS TENSION QUAND LA BOBINE DE DEMAGNETISATION EST ENLEVÉE.

ATTENTION AUX COMPOSANTS RELATIFS À LA SÉCURITÉ!!

LES COMPOSANTS IDENTIFIÉS PAR UNE TRAME ET UNE MARQUE \triangle SONT CRITIQUES POUR LA SÉCURITÉ. NE LES REMPLACER QUE PAR UNE PIÈCE PORTANT LE NUMÉRO SPECIFIÉ. LES RÉGLAGES DE CIRCUIT DONT L'IMPORTANCE EST CRITIQUE POUR LA SÉCURITÉ DU FONCTIONNEMENT SONT IDENTIFIÉS DANS LE PRÉSENT MANUEL. SUIVRE CES PROCÉDURES LORS DE CHAQUE REMPLACEMENT DE COMPOSANTS CRITIQUES, OU LORSQU'UN MAUVAIS FONCTIONNEMENT EST SUSPECTÉ.

TABLE OF CONTENTS

<i>Section</i>	<i>Title</i>	<i>Page</i>
1. GENERAL	1-1
2. DISASSEMBLY		
2-1.	Cabinet Removal	2-1
2-2.	Service Position	2-1
2-3.	D Board Removal	2-1
2-4.	Picture Tube Removal	2-2
2-5.	Harnes Location	2-3
3. SAFETY RELATED ADJUSTMENT	3-1
4. ADJUSTMENTS	4-1
5. DIAGRAMS		
5-1.	Block Diagrams (with Frame Schematic Diagram)	5-1
5-2.	Circuit Boards Location	5-5
5-3.	Schematic Diagrams and Printed Wiring Boards ...	5-5
	(1) Schematic Diagram of D-a Board	5-6
	(2) Schematic Diagram of D-b Board	5-9
	(3) Schematic Diagram of D-c Board	5-13
	(4) Schematic Diagram of A Board	5-17
5-4.	Semiconductors	5-20
6. EXPLODED VIEWS		
6-1.	Chassis	6-1
6-2.	Packing Materials	6-2
7. ELECTRICAL PARTS LIST	7-1

SECTION 1 GENERAL

The operating instructions mentioned here are partial abstracts from the Operating Instruction Manual. The page numbers of the Operating Instruction Manual remain as in the manual.

Precautions

Warning on power connections

- Use the supplied power cord. If you use a different power cord, be sure that it is compatible with your local power supply.
For the customers in the U.S.A.
If you do not use the appropriate cord, this monitor will not conform to mandatory FCC standards.

Example of plug types

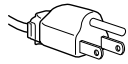

for 100 to 120 V AC

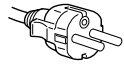

for 200 to 240 V AC

- Before disconnecting the power cord, wait at least 30 seconds after turning off the power to allow the static electricity on the screen's surface to discharge.
- After the power is turned on, the screen is demagnetized (degaussed) for about 5 seconds. This generates a strong magnetic field around the screen which may affect data stored on magnetic tapes and disks placed near the monitor. Be sure to keep magnetic recording equipment, tapes, and disks away from the monitor.

The equipment should be installed near an easily accessible outlet.

Installation

Do not install the monitor in the following places:

- on surfaces (rugs, blankets, etc.) or near materials (curtains, draperies, etc.) that may block the ventilation holes
- near heat sources such as radiators or air ducts, or in a place subject to direct sunlight
- in a place subject to severe temperature changes
- in a place subject to mechanical vibration or shock
- on an unstable surface
- near equipment which generates magnetism, such as a transformer or high voltage power lines
- near or on an electrically charged metal surface

Maintenance

- Clean the screen with a soft cloth. If you use a glass cleaning liquid, do not use any type of cleaner containing an anti-static solution or similar additive as this may scratch the screen's coating.
- Do not rub, touch, or tap the surface of the screen with sharp or abrasive items such as a ballpoint pen or screwdriver. This type of contact may result in a scratched picture tube.
- Clean the cabinet, panel and controls with a soft cloth lightly moistened with a mild detergent solution. Do not use any type of abrasive pad, scouring powder or solvent, such as alcohol or benzene.

Transportation

When you transport this monitor for repair or shipment, use the original carton and packing materials.

Use of the tilt-swivel

This monitor can be adjusted within the angles shown below. To turn the monitor vertically or horizontally, hold it at the bottom with both hands.

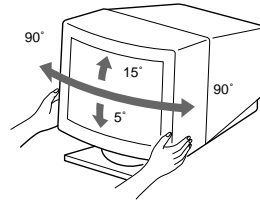

Identifying parts and controls

See the pages in parentheses for further details.

Front

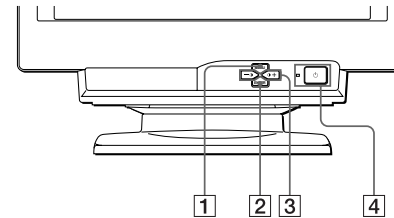

- MENU button (page 9)**
This button displays the MENU OSD.
- ENTER button (page 9)**
This button selects the menu and adjustment items.
- (contrast) +/- buttons (page 9)**
These buttons display the CONTRAST/BRIGHTNESS menu and function as the +/- buttons when adjusting other items.
- (power) switch and indicator (pages 6, 13, 16)**
This button turns the monitor on and off. The power indicator lights up in green when the monitor is turned on, and either flashes in green and orange, or lights up in orange when the monitor is in power saving mode.

Rear

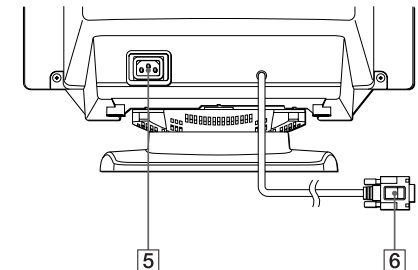

- AC IN connector (page 6)**
This connector provides AC power to the monitor.
- Video input connector (HD15) (page 6)**
This connector inputs RGB video signals (0.700 Vp-p, positive) and sync signals.

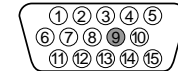

Pin No.	Signal
1	Red
2	Green
3	Blue
4	ID (Ground)
5	DDC Ground*
6	Red Ground
7	Green Ground
8	Blue Ground
9	-
10	Ground
11	ID (Ground)
12	Bi-Directional Data (SDA)*
13	H. Sync
14	V. Sync
15	Data Clock (SCL)*

* DDC (Display Data Channel) is a standard of VESA.

Setup

Before using your monitor, check that the following accessories are included in your carton:

- Power cord (1)
- Windows Monitor Information Disk (1)
- Warranty card (1)
- Notes on cleaning the screen's surface (1)
- This instruction manual (1)

Step 1: Connect your monitor to your computer

Turn off the monitor and computer before connecting.

■ Connecting to an IBM PC/AT or compatible computer

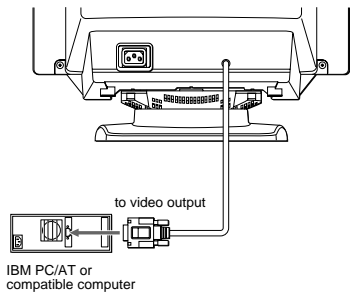

■ Connecting to a Macintosh or compatible computer

You will need a Macintosh adapter (not supplied).

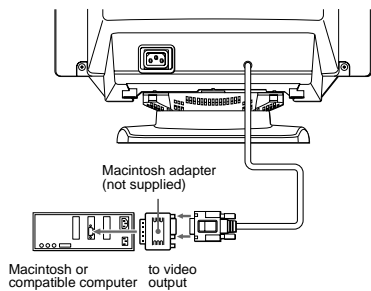

Step 2: Connect the power cord

With the monitor and computer switched off, first connect the power cord to the monitor, then connect it to a power outlet.

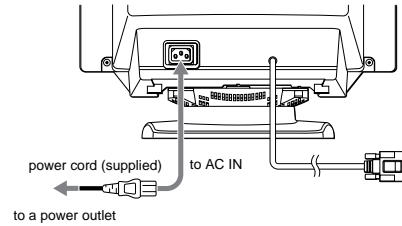

Step 3: Turn on the monitor and computer

First turn on the monitor, then turn on the computer.



The installation of your monitor is complete. If necessary, use the monitor's controls to adjust the picture.

If no picture appears on your screen

- Check that the monitor is correctly connected to the computer.
- If NO INPUT SIGNAL appears on the screen, confirm that your computer's graphic board is completely seated in the correct bus slot.
- If you are replacing an old monitor with this model and OUT OF SCAN RANGE appears on the screen, reconnect the old monitor. Then adjust the computer's graphic board so that the horizontal frequency is between 30 – 70 kHz, and the vertical frequency is between 48 – 120 Hz.

For more information about the on-screen messages, see "Trouble symptoms and remedies" on page 14.

For customers using Windows 95/98

To maximize the potential of your monitor, install the new model information file from the supplied Windows Monitor Information Disk onto your PC. This monitor complies with the "VESA DDC" Plug & Play standard. If your PC/graphics board complies with DDC, select "Plug & Play Monitor (VESA DDC)" or this monitor's model name as the monitor type in the "Control Panel" of Windows 95/98. If your PC/graphics board has difficulty communicating with this monitor, load the Windows Monitor Information Disk and select this monitor's model name as the monitor type.

For customers using Windows NT4.0

Monitor setup in Windows NT4.0 is different from Windows 95/98 and does not involve the selection of monitor type. Refer to the Windows NT4.0 instruction manual for further details on adjusting the resolution, refresh rate, and number of colors.

Adjusting the monitor's resolution and color number

Adjust the monitor's resolution and color number by referring to your computer's instruction manual. The color number may vary according to your computer or video board. The color palette setting and the actual number of colors are as follows:

- High Color (16 bit) → 65,536 colors
- True Color (24 bit) → about 16.77 million colors

In true color mode (24 bit), speed may be slower.

Selecting the on-screen menu language (LANGUAGE/ INFORMATION)

English, French, German, Spanish, and Italian versions of the on-screen menus are available. The default setting is English.

1 Press the MENU button.

See page 9 for more information on using the MENU button.

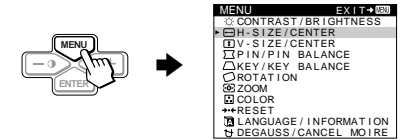

2 Press the +/- buttons to highlight LANGUAGE/ INFORMATION and press the ENTER button.

See page 9 for more information on using the +/- and ENTER buttons.



3 Press the ENTER button to select LANGUAGE and press +/- buttons to select a language.

- ENGLISH
- FRANÇAIS: French
- DEUTSCH: German
- ESPAÑOL: Spanish
- ITALIANO: Italian

To close the menu

Press the MENU button once to return to the main menu, and twice to return to normal viewing. If no buttons are pressed, the menu closes automatically after about 30 seconds.

To reset to English

See "Resetting the adjustments (RESET)" on page 12.

Customizing Your Monitor

You can make numerous adjustments to your monitor using the on-screen menu.

Navigating the menu

Press the MENU button to display the main MENU on your screen. See page 9 for more information on using the MENU button.

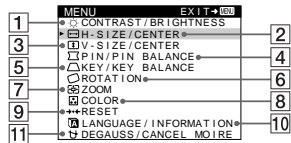

Use the +/- and ENTER buttons to select one of the following menus. See page 9 for more information on using the +/- and ENTER buttons.

- 1 CONTRAST/BRIGHTNESS (page 9)**
Select the CONTRAST/BRIGHTNESS menu to adjust the picture's contrast and brightness.

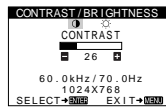

- 2 H-SIZE/CENTER (page 10)**
Select the H-SIZE/CENTER menu to adjust the picture's horizontal size and centering.

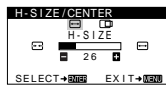

- 3 V-SIZE/CENTER (page 10)**
Select the V-SIZE/CENTER menu to adjust the picture's vertical size and centering.

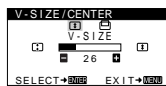

- 4 PIN/PIN BALANCE (page 10)**
Select the PIN/PIN BALANCE menu to adjust the curvature picture's sides.

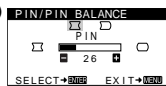

- 5 KEY/KEY BALANCE (page 10)**
Select the KEY/KEY BALANCE menu to adjust the angle of the picture's sides.

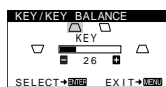

- 6 ROTATION (page 11)**
Select the ROTATION menu to adjust the picture's rotation.

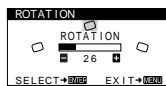

- 7 ZOOM (page 11)**
Select the ZOOM menu to enlarge or reduce the picture.

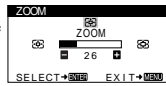

- 8 COLOR (page 11)**
Select the COLOR menu to adjust the picture's color temperature. You can use this to match the monitor's colors to a printed picture's colors.



- 9 RESET (page 12)**
Select the RESET menu to reset the adjustments.

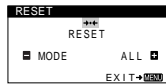

- 10 LANGUAGE/INFORMATION (page 7, 15)**
Select the LANGUAGE/INFORMATION menu to choose the on-screen menu's language and display this monitor's information box.

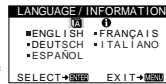

- 11 DEGAUSS/CANCEL MOIRE (page 12)**
Select the DEGAUSS/CANCEL MOIRE menu to degauss the screen and cancel the moire.

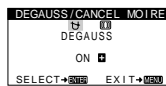

- Displaying the current input signal**
The horizontal and vertical frequencies of the current input signal are displayed in the CONTRAST/BRIGHTNESS menu. If the signal matches one of this monitor's factory preset modes, the resolution is also displayed.

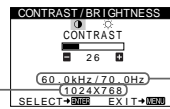

the resolution of the current input signal

the horizontal and vertical frequencies of the current input signal

■ Using the MENU, ENTER, and +/- buttons

- 1 Select the menu you want to adjust.**
Press the +/- buttons to highlight the desired menu. Press the ENTER button to select the menu and adjustment items.

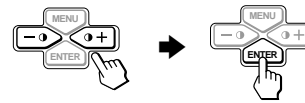

- 2 Adjust the menu.**
Press the +/- buttons to make the adjustment.

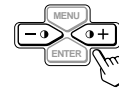

- 3 Close the menu.**
Press the MENU button once to return to the main menu, and twice to return to normal viewing. If no buttons are pressed, the menu closes automatically after about 30 seconds.



- Resetting the adjustments**
You can reset the adjustments using the RESET menu. See page 12 for more information on resetting the adjustments.

Adjusting the contrast and brightness (CONTRAST/BRIGHTNESS)

These settings are stored in memory for all input signals.

- 1 Press either one of the (CONTRAST) +/- buttons.**
The CONTRAST/BRIGHTNESS menu appears on the screen.

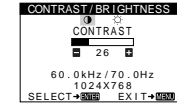



- 2 Press the ENTER button to select (CONTRAST) or (BRIGHTNESS).**
- 3 Press the +/- buttons to adjust either the contrast (CONTRAST) or brightness (BRIGHTNESS).**
The menu automatically disappears after about 30 seconds.

Adjusting the horizontal size or centering of the picture (H-SIZE/CENTER)

These settings are stored in memory for the current input signal.



- 1 Press the MENU button.**
The main MENU appears on the screen.
- 2 Press the +/- buttons to highlight  H-SIZE/CENTER, and press the ENTER button.**
The H-SIZE/CENTER menu appears on the screen.
- 3 First press the ENTER button to select the desired adjustment item. Then press the +/- buttons to make the adjustment.**

Select	To
 H-SIZE	adjust the horizontal size
 H-CENTER	adjust the horizontal centering

Adjusting the vertical size or centering of the picture (V-SIZE/CENTER)

These settings are stored in memory for the current input signal.



- 1 Press the MENU button.**
The main MENU appears on the screen.
- 2 Press the +/- buttons to highlight  V-SIZE/CENTER, and press the ENTER button.**
The V-SIZE/CENTER menu appears on the screen.
- 3 First press the ENTER button to select the desired adjustment item. Then press the +/- buttons to make the adjustment.**

Select	To
 V-SIZE	adjust the vertical size
 V-CENTER	adjust the vertical centering

Adjusting the curvature of the picture's sides (PIN/PIN BALANCE)

These settings are stored in memory for the current input signal.



- 1 Press the MENU button.**
The main MENU appears on the screen.
- 2 Press the +/- buttons to highlight  PIN/PIN BALANCE, and press the ENTER button.**
The PIN/PIN BALANCE menu appears on the screen.
- 3 First press the ENTER button to select the desired adjustment item. Then press the +/- buttons to make the adjustment.**

Select	To
 PIN	expand or contract the picture sides
 PIN BALANCE	shift the picture sides to the left or right

Adjusting the angle of the picture's sides (KEY/KEY BALANCE)

These settings are stored in memory for the current input signal.

- 1 Press the MENU button.**
The main MENU appears on the screen.
- 2 Press the +/- buttons to highlight  KEY/KEY BALANCE, and press the ENTER button.**
The KEY/KEY BALANCE menu appears on the screen.
- 3 First press the ENTER button to select the desired adjustment item. Then press the +/- buttons to make the adjustment.**

Select	To
 KEY	adjust the picture width at the top of the screen
 KEY BALANCE	shift the picture to the left or right at the top of the screen

Adjusting the picture's rotation (ROTATION)

This setting is stored in memory for all input signals.

- 1 Press the MENU button.**
The main MENU appears on the screen.
- 2 Press the +/- buttons to highlight  ROTATION, and press the ENTER button.**
The ROTATION menu appears on the screen.
- 3 Press the +/- buttons to rotate the picture.**

Enlarging or reducing the picture (ZOOM)

This setting is stored in memory for the current input signal.

- 1 Press the MENU button.**
The main MENU appears on the screen.
- 2 Press the +/- buttons to highlight  ZOOM and press the ENTER button.**
The ZOOM menu appears on the screen.
- 3 Press the +/- buttons to enlarge or reduce the picture.**

Note

Adjustment stops when either the horizontal or vertical size reaches its maximum or minimum value.

Adjusting the color of the picture (COLOR)

The COLOR settings allow you to adjust the picture's color temperature by changing the color level of the white color field. Colors appear reddish if the temperature is low, and bluish if the temperature is high. This adjustment is useful for matching the monitor's colors to a printed picture's colors. This setting is stored in memory for all input signals.

- 1 Press the MENU button.**
The main MENU appears on the screen.
- 2 Press the +/- buttons to highlight  COLOR and press the ENTER button.**
The COLOR menu appears on the screen.
- 3 Press the +/- buttons to select a color temperature.**
The preset color temperatures are 5000K, 6500K, and 9300K. Since the default setting is 9300K, the whites will change from a bluish hue to a reddish hue as the temperature is lowered to 6500K and 5000K.
- 4 If necessary, fine tune the color temperature.**
First press the +/- buttons to select USER. Then press the ENTER button to select R (red), G (green), or B (blue) and press the +/- buttons to make the adjustment.

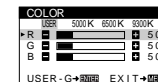

If you fine tune the color temperature, the new color settings are stored in memory and recalled whenever you select USER.

US

Additional settings (DEGAUSS/ CANCEL MOIRE)

You can manually degauss (demagnetize) the screen, and cancel the moire.

- 1 Press the MENU button.**
The main MENU appears on the screen.
- 2 Press the +/- buttons to highlight DEGAUSS/ CANCEL MOIRE and press the ENTER button.**
The DEGAUSS/CANCEL MOIRE menu appears on the screen.
- 3 Press the ENTER button to select the desired adjustment item.**
Adjust the selected item according to the following instructions.

Degaussing the screen

The monitor is automatically demagnetized when the power is turned on.

To manually degauss the monitor, first press the ENTER button to select DEGAUSS. Then press the + button.

The screen is degaussed for about 5 seconds. If a second degauss cycle is needed, allow a minimum interval of 20 minutes for the best result.

Cancelling the moire

If elliptical or wavy patterns appear on the screen, adjust the moire cancellation level.

To adjust the amount of moire cancellation, first press the ENTER button to select CANCEL MOIRE. Then press the +/- buttons until the moire effect is at a minimum.

* Moire is a type of natural interference which produces soft, wavy lines on your screen. It may appear due to interference between the pattern of the picture on the screen and the phosphor pitch pattern of the monitor.

Example of moire



Resetting the adjustments (RESET)

This monitor has the following two reset methods. Use the RESET menu to reset the adjustments.

- 1 Press the MENU button.**
The main MENU appears on the screen.
- 2 Press the +/- buttons to highlight RESET and press the ENTER button.**
The RESET menu appears on the screen.
Reset the settings according to the following instructions.

Resetting all of the adjustment data for the current input signal (MODE)

Press the - button.

The MODE item is selected. All of the adjustment data for the current input signal is reset.

Note that the following items are not reset by this method:

- on-screen menu language (page 7)
- picture's rotation (page 11)

Resetting all of the adjustment data to factory preset levels (ALL)

Press the + button.

The ALL item is selected. With the exception of the USER settings in the COLOR menu, all of the adjustment data for all input signals is reset to the factory preset levels.

Note

The monitor's buttons will not operate for about 5 seconds when ALL is selected.

Technical Features

Preset and user modes

When the monitor receives an input signal, it automatically matches the signal to one of the factory preset modes stored in the monitor's memory to provide a high quality picture at the center of the screen. (See Appendix for a list of the factory preset modes.) For input signals that do not match one of the factory preset modes, the digital Multiscan technology of this monitor ensures that a clear picture appears on the screen for any timing in the monitor's frequency range (horizontal: 30 – 70 kHz, vertical: 48 – 120 Hz). If the picture is adjusted, the adjustment data is stored as a user mode and automatically recalled whenever the same input signal is received.

Note for Windows users

For Windows users, check your video board manual or the utility program which comes with your graphic board and select the highest available refresh rate to maximize monitor performance.

Power saving function

This monitor meets the power-saving guidelines set by VESA, ENERGY STAR, and NUTEK. If the monitor is connected to a computer or video graphics board that is DPMS (Display Power Management Signaling) compliant, the monitor will automatically reduce power consumption in three stages as shown below.

Power mode	Power consumption	⏻ (power) indicator
normal operation	≤ 110 W (CPD-210GS) ≤ 105 W (CPD-110GS)	green
1 standby	≤ 15 W	green and orange alternate
2 suspend	≤ 15 W	green and orange alternate
3 active off*	≤ 5 W	orange
power off	0 W	off

* When your computer enters the "active off" mode, the input signal is cut and NO INPUT SIGNAL appears on the screen. After 20 seconds, the monitor enters the power saving mode.

Troubleshooting

Before contacting technical support, refer to this section.

If thin lines appear on your screen (damper wires)

The lines you are experiencing on your screen are normal for the Trinitron monitor and are not a malfunction. These are shadows from the damper wires used to stabilize the aperture grille and are most noticeable when the screen's background is light (usually white). The aperture grille is the essential element that makes a Trinitron picture tube unique by allowing more light to reach the screen, resulting in a brighter, more detailed picture.

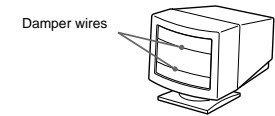

On-screen messages

If there is something wrong with the input signal, one of the following messages appears on the screen. To solve the problem, see "Trouble symptoms and remedies" on page 14.

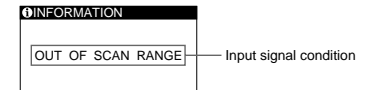

The input signal condition

OUT OF SCAN RANGE





indicates that the input signal is not supported by the monitor's specifications.

NO INPUT SIGNAL

indicates that no signal is being input to the monitor.

Trouble symptoms and remedies



If the problem is caused by the connected computer or other equipment, please refer to the connected equipment's instruction manual. Use the self-diagnosis function (page 16) if the following recommendations do not resolve the problem.

Symptom	Check these items
No picture	
If the  (power) indicator is not lit	<ul style="list-style-type: none"> Check that the power cord is properly connected. Check that the  (power) switch is in the "on" position.
If the NO INPUT SIGNAL message appears on the screen, or if the  (power) indicator is either orange or alternating between green and orange	<ul style="list-style-type: none"> Check that the video signal cable is properly connected and all plugs are firmly seated in their sockets (page 6). Check that the HD15 video input connector's pins are not bent or pushed in. <p>■ Problems caused by the connected computer or other equipment</p> <ul style="list-style-type: none"> The computer is in power saving mode. Try pressing any key on the computer keyboard. Check that the computer's power is "on." Check that the graphic board is completely seated in the proper bus slot.
If the OUT OF SCAN RANGE message appears on the screen	<p>■ Problems caused by the connected computer or other equipment</p> <ul style="list-style-type: none"> Check that the video frequency range is within that specified for the monitor. If you replaced an old monitor with this monitor, reconnect the old monitor and adjust the frequency range to the following. Horizontal: 30~70 kHz Vertical: 48~120 Hz
If no message is displayed and the  (power) indicator is green or flashing orange	<ul style="list-style-type: none"> Use the Self-diagnosis function (page 16).
If using Windows 95/98	<ul style="list-style-type: none"> If you replaced an old monitor with this monitor, reconnect the old monitor and do the following. Install the Windows Monitor Information Disk (page 7) and select this monitor ("CPD-110GS" or "CPD-210GS") from among the Sony monitors in the Windows 95/98 monitor selection screen.
If using a Macintosh system	<ul style="list-style-type: none"> Check that the Macintosh adapter (not supplied) and the video signal cable are properly connected (page 6).
Picture flickers, bounces, oscillates, or is scrambled	<ul style="list-style-type: none"> Isolate and eliminate any potential sources of electric or magnetic fields such as other monitors, laser printers, electric fans, fluorescent lighting, or televisions. Move the monitor away from power lines or place a magnetic shield near the monitor. Try plugging the monitor into a different AC outlet, preferably on a different circuit. Try turning the monitor 90° to the left or right. <p>■ Problems caused by the connected computer or other equipment</p> <ul style="list-style-type: none"> Check your graphics board manual for the proper monitor setting. Confirm that the graphics mode (VESA, Macintosh 16" Color, etc.) and the frequency of the input signal are supported by this monitor (Appendix). Even if the frequency is within the proper range, some video boards may have a sync pulse that is too narrow for the monitor to sync correctly. Adjust the computer's refresh rate (vertical frequency) to obtain the best possible picture.
Picture is fuzzy	<ul style="list-style-type: none"> Adjust the contrast and brightness (page 9). Degauss the monitor* (page 12). Decrease the moire cancellation effect (page 12).

Symptom	Check these items
Picture is ghosting	<ul style="list-style-type: none"> Eliminate the use of video cable extensions and/or video switch boxes. Check that all plugs are firmly seated in their sockets.
Picture is not centered or sized properly	<ul style="list-style-type: none"> Adjust the size or centering (page 10). Note that some video modes do not fill the screen to the edges.
Edges of the image are curved	<ul style="list-style-type: none"> Adjust the shape of the picture (page 10).
Wavy or elliptical pattern (moire) is visible	<ul style="list-style-type: none"> Cancel the moire (page 12). <p>■ Problems caused by the connected computer or other equipment</p> <ul style="list-style-type: none"> Change your desktop pattern.
Color is not uniform	<ul style="list-style-type: none"> Degauss the monitor* (page 12). If you place equipment that generates a magnetic field, such as a speaker, near the monitor, or if you change the direction the monitor faces, color may lose uniformity.
White does not look white	<ul style="list-style-type: none"> Adjust the color temperature (page 11).
A hum is heard right after the power is turned on	<ul style="list-style-type: none"> This is the sound of the auto-degauss cycle. When the power is turned on, the monitor is automatically degaussed for 5 seconds.

* If a second degauss cycle is needed, allow a minimum interval of 20 minutes for the best result. A humming noise may be heard, but this is not a malfunction.

Displaying this monitor's name, serial number, and date of manufacture (INFORMATION)

- 1 Press the MENU button.**
The main MENU appears on the screen.
- 2 Press the +/- buttons to highlight  LANGUAGE/INFORMATION and press the ENTER button.**
The LANGUAGE/INFORMATION menu appears on the screen.
- 3 Press the ENTER button to select  (INFORMATION).**
This monitor's information box appears on the screen.

If the problem persists, call your authorized Sony dealer and give the following information.

- Model name: CPD-110GS or CPD-210GS
- Serial number
- Name and specifications of your computer and graphics board.

US

Example

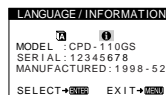

Self-diagnosis function

This monitor is equipped with a self-diagnosis function. If there is a problem with your monitor or computer, the screen will go blank and the ⏻ (power) indicator will either light up green or flash orange. If the ⏻ (power) indicator is lit in orange, the computer is in power saving mode. Try pressing any key on the keyboard.

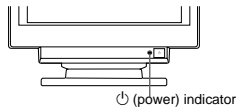

If the ⏻ (power) indicator is green

- 1 **Disconnect the video input cable, or turn off the connected computer.**
- 2 **Press the ⏻ (power) button to turn the monitor off and on.**
- 3 **Press and hold the + button for 2 seconds before the monitor enters power saving mode.**

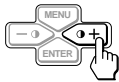

If all three color bars appear (red, green, blue), the monitor is working properly. Reconnect the video input cables and check the condition of your computer.

If the color bars do not appear, there is a potential monitor failure. Inform your authorized Sony dealer of the monitor's condition.

If the ⏻ (power) indicator is flashing orange

Press the ⏻ (power) button to turn the monitor off and on.

If the ⏻ (power) indicator lights up green, the monitor is working properly.

If the ⏻ (power) indicator is still flashing, there is a potential monitor failure. Count the number of seconds between orange flashes of the ⏻ (power) indicator and inform your authorized Sony dealer of the monitor's condition. Be sure to note the model name and serial number of your monitor. Also note the make and model of your computer and video board.

SECTION 2 DISASSEMBLY

2-1. CABINET REMOVAL

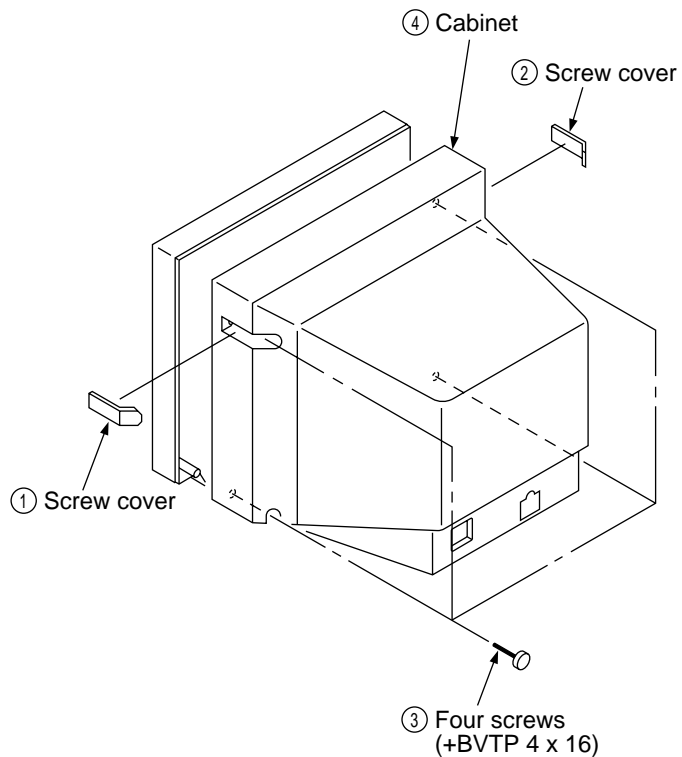

2-2. SERVICE POSITION

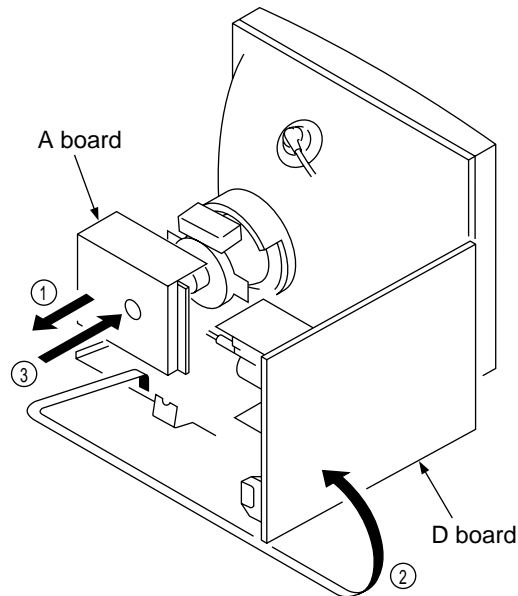

2-3. D BOARD REMOVAL

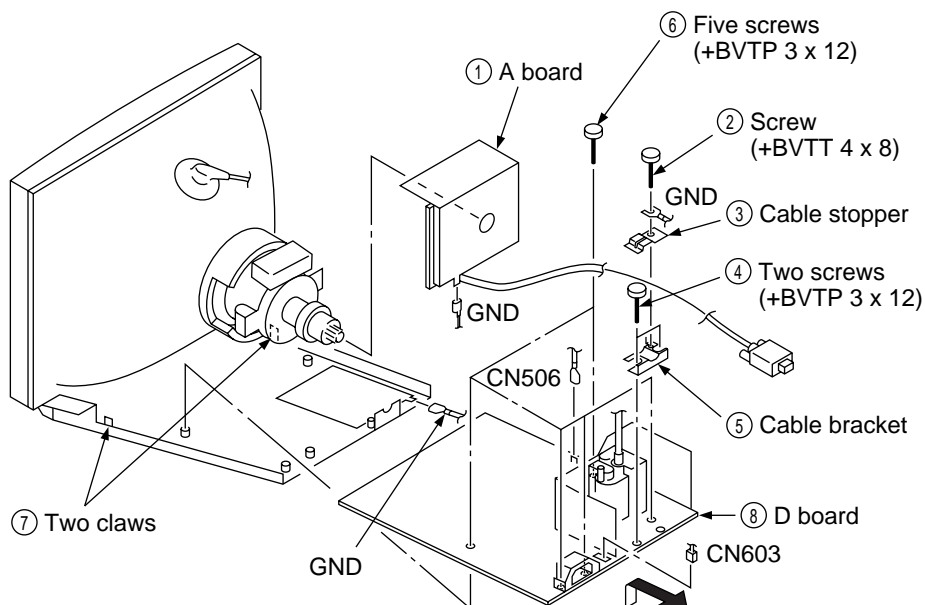

2-4. PICTURE TUBE REMOVAL

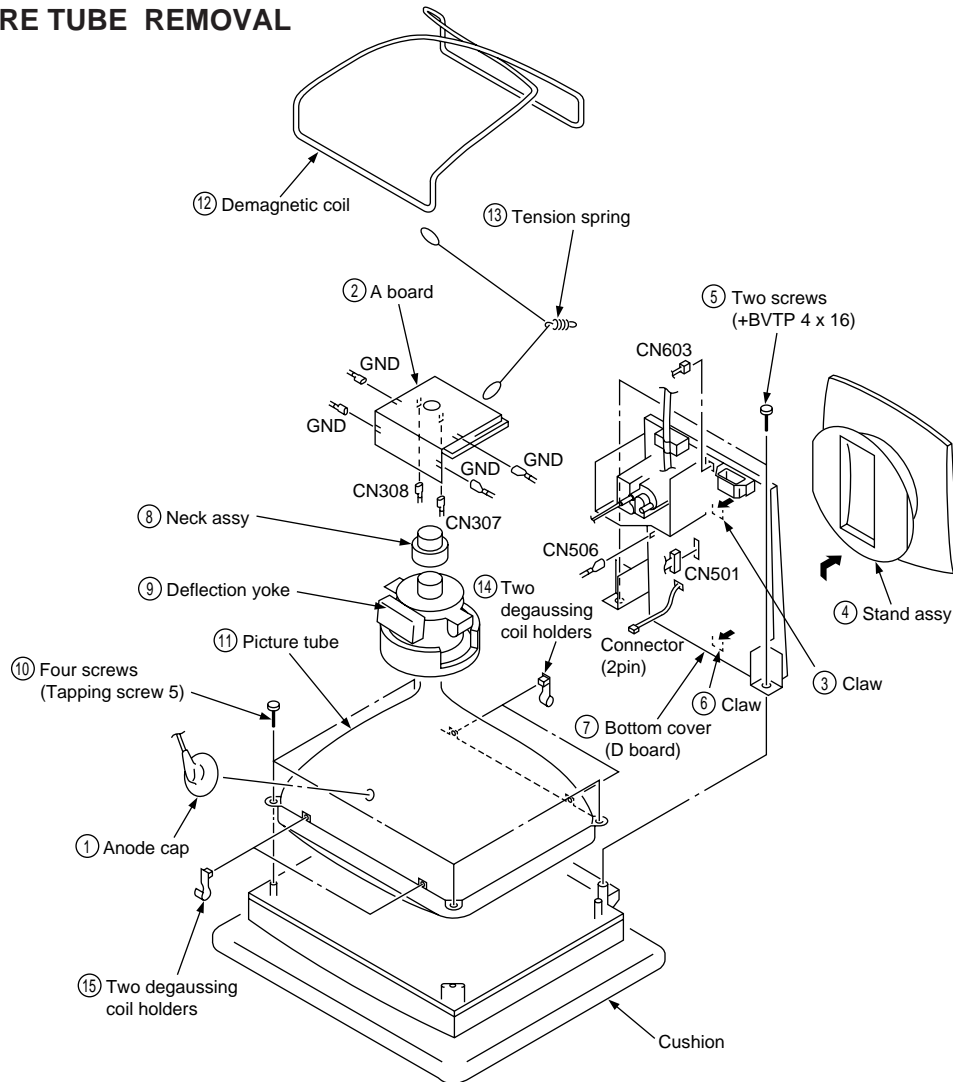

• REMOVAL OF ANODE-CAP

NOTE: Short circuit the anode of the picture tube and the anode cap to the metal chassis, CRT shield or carbon painted on the CRT, after removing the anode.

• REMOVING PROCEDURES

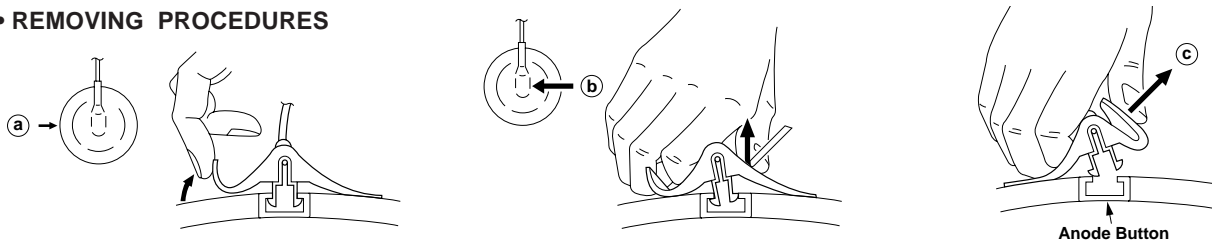

- ① Turn up one side of the rubber cap in the direction indicated by the arrow (a).
- ② Using a thumb pull up the rubber cap firmly in the direction indicated by the arrow (b).
- ③ When one side of the rubber cap is separated from the anode button, the anode-cap can be removed by turning up the rubber cap and pulling up it in the direction of the arrow (c).

• HOW TO HANDLE AN ANODE-CAP

- ① Don't hurt the surface of anode-caps with sharp shaped material!
- ② Don't press the rubber hardly not to hurt inside of anode-caps!
A material fitting called as shatter-hook terminal is built in the rubber.
- ③ Don't turn the foot of rubber over hardly!
The shatter-hook terminal will stick out or hurt the rubber.

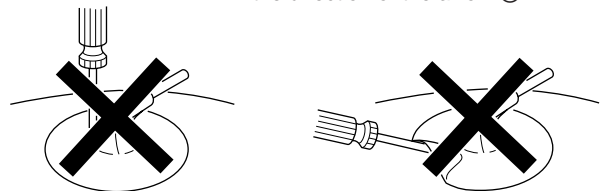

2-5. HARNESS LOCATION

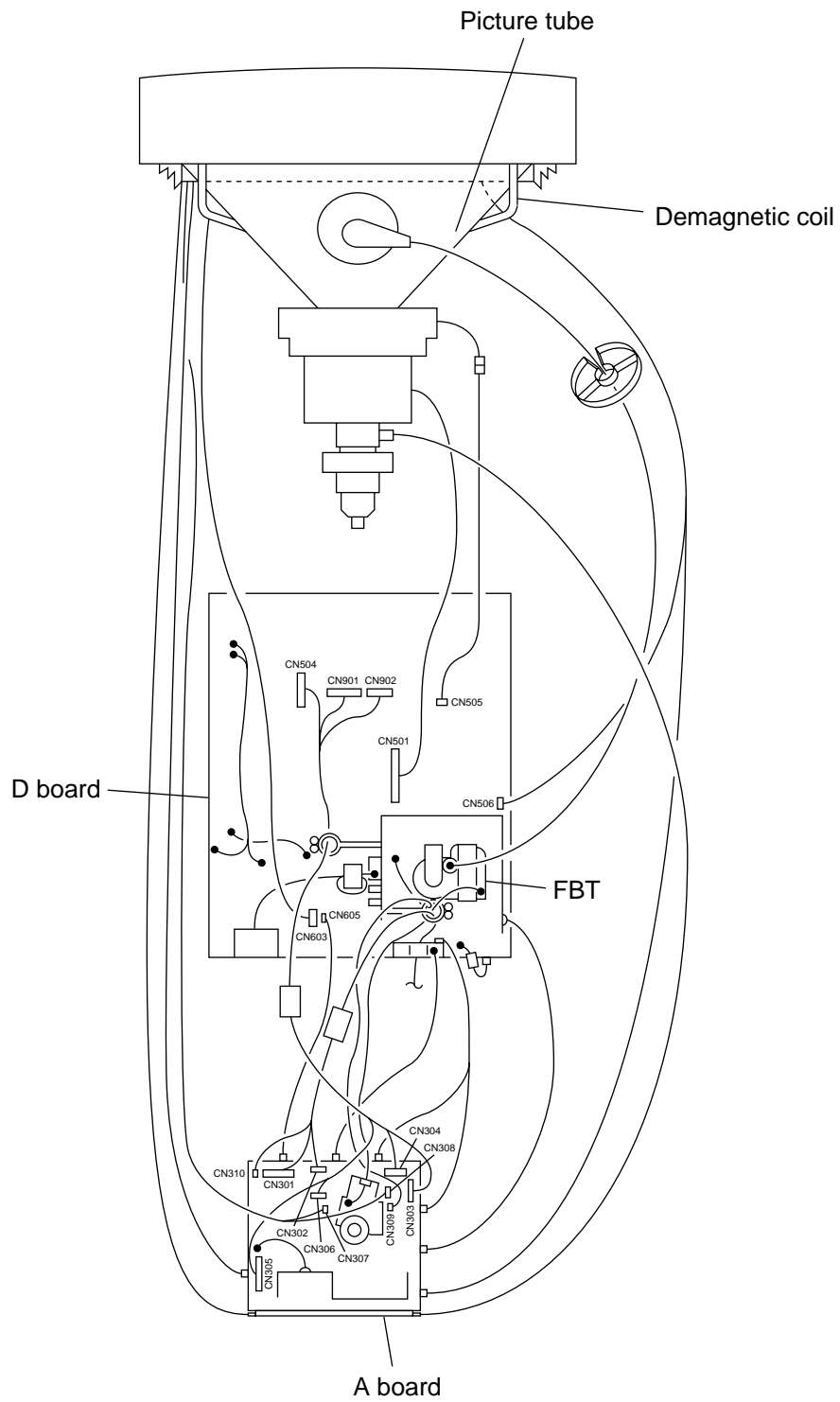

SAFETY RELATED ADJUSTMENT

When replacing or repairing the shown below table, the following operational checks must be performed as a safety precaution against X-rays emissions from the unit.

	Part Replaced (☒)
HV ADJ	RV501

	Part Replaced (☑)
HV Regulator Circuit Check	D board IC502, IC503, C501, C535, C553, C597, C598, R592, R593, R596, RV501, T501 (FBT)
HV Hold-down Circuit Check	D board IC501, D521, C585, C599, R598, R599, R5C7, T501 (FBT)
Beam Current Protector Circuit Check	D board Q533, D592, C590, C591, C598, R5A5, R5C0, R5C3, L502, T501 (FBT)

* Confirm one minute later turning on the power.

- **HV Protector Circuit Check**

Confirm that the voltage between cathode of D521 on D board and GND is more than 28.5 V DC and Using external DC Power Supply, apply the voltage shown below between cathode of D521 and GND, and confirm that the HV HOLD DOWN circuite works. (TV Rester disappears)

Standard voltage : Less than 34 V DC

Check Condition

- Input voltage : 100 – 120 V AC
- Input signal : White Cross hatch at Max fH
- Beam control : CONT : 255, BRT : 80

- **Beam Current Protector Check**

Connect a variable resistor (250 kΩ or more) and an ammeter in series between FBT pin ① on D board and GND. Decrease gradually the resistance of the variable resistor from maximum to minimum, and confirm that the Beam Current Protector Circuite works (TV Rester disappears). The current must be within the range shown below.

- Standard current : Less than 1.50 mA

Check Condition

- Input voltage : 100 – 120 V AC
- Input signal : White Cross hatch at Max fH
- Beam control : CONT : 255, BRT : 80

- **B+ Voltage Check**

Standard voltage : 152 ± 5.0 V DC

Check Condition

- Input voltage : 100 – 120 V AC
- Note : Use NF power supply or make sure that distortion factor is 3% or less.
- Input signal : White Cross hatch at 64.0 kHz
- Beam control : CONT : 255, BRT : 80

SECTION 4 ADJUSTMENTS

Connect the communication cable of the computer to the connector located on the D board on the monitor. Run the service software and then follow the instruction.

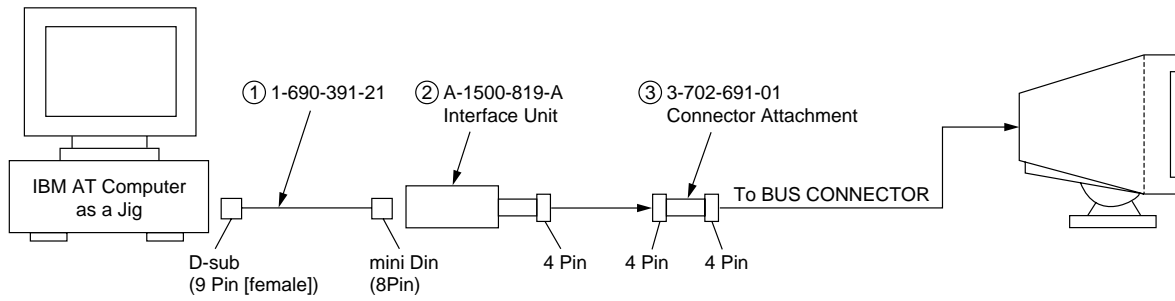

*The parts above (①) ~ (③) are necessary for DAS adjustment.

• Landing Fine Adjustment

< Measurement condition >

Magnetic field : BH=0, BV=45 μ T

CRT size : 270 × 202

Measurement point : 240 × 180

Temperature : 25°C (after aging for 12 hours)

< Adjustment target >

- 1) The value shall be within the following specification after 0.5 hours of aging in the product condition, all white and with luminance 100cd/m².

-2	-1	1
-1	0	0
1	0	-1

- 2) The value shall be within the following specification after 3 hours of aging in product condition, 1/2 Σ 1K (not including dark current).

0	0	0
0	0	0
0	0	0

Tolerance +/- 7.

1. Put the set inside the Helmholtz coil.
2. Input the single green signal.
3. Demagnetize the CRT surface with the hand degausser.
4. Attach the wobbling coil to the designated part of the CRT neck.
5. Attach the sensor of the landing adjustment unit on the CRT surface.
6. Adjust the DY position and purity, and the DY tilt.
7. Fasten DY with screw.

Note: Torque 22 \pm 2kgcm (2.2 \pm 0.2Nm)

• Convergence Adjustment

- * Set DY four-pole magnet at mechanical center before adjustment.
- * This should be prime mode.

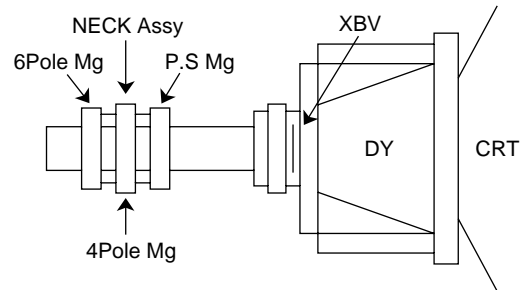

Correcting XBV

In case

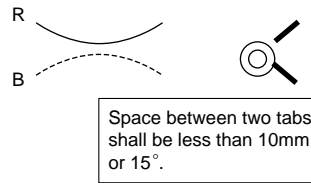

Open 4 pole magnet of DY, Be careful don't not to change H-STAT.

In this case

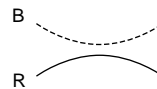

- 1) Open 4 pole magnet of DY. Shall not change HSTAT.
- 2) Re-adjust V-STAT with 4 pole magnet of neck ass'y. Don't not perform the XBV correction excessively unless otherwise necessary.

1. Receive R.B. cross-hatch.
2. Adjust H.STAT nad V.STAT at four-pole magnet.

<4 Pole Magnet>

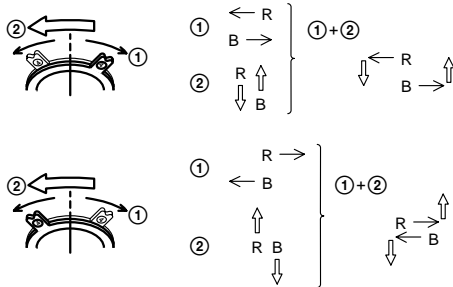

3. Receive White cross-hatch.
4. Adjust HMC and VMC at six-pole magnet.

<6 Pole Magnet>

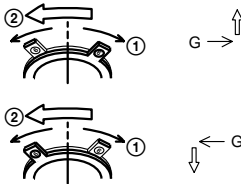

5. Receive R.B. cross-hatch.
6. Adjust XBV with four-pole magnet of DY.
7. Repeat adjustment step from above step 1) to 6) and make R.G.B of bote vertical and horizontal line to be overlay at both x and y axes.
8. Adjust H.TILT by swinging the DY neck right and left.
9. Light tighten the lock on the magnet ass'y Neck ass'y so that the magnet will be move easily.
10. Adjust XCV with XCV core.

XCV movement

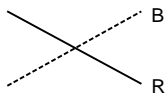

11. Adjust V.TILT with TLV VR.

TLV movement

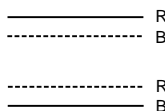

12. Adjust Y.CLOTH with YCH VR.

YCH movement

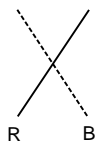

13. Paint lock the four-pole and six-pole magnet of neck ass'y and also four-pole magnet of DY.

<VR Adjustment on DY>

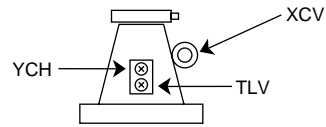

• Vertical and Horizontal Position and Size Specification

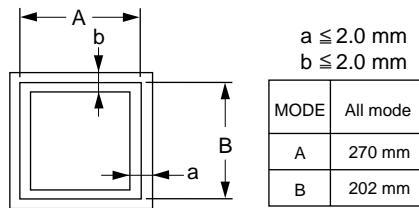

• Convergence Specification

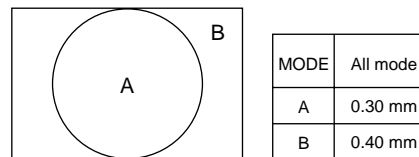

• White Balance Adjustment Specification

- (1) 9300K
 $x = 0.283 \pm 0.01$
 $y = 0.287 \pm 0.01$
- (2) 6500K
 $x = 0.313 \pm 0.01$
 $y = 0.329 \pm 0.01$
- (3) 5000K
 $x = 0.346 \pm 0.01$
 $y = 0.359 \pm 0.01$

• Focus adjustment

Adjustment focus (V) and focus (H) for optimum focus.

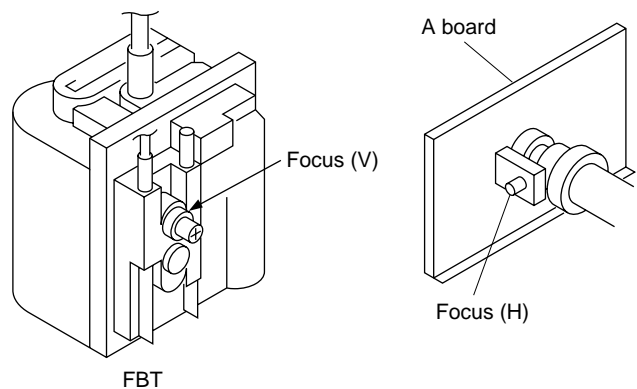

SECTION 5 DIAGRAMS

5-1. BLOCK DIAGRAMS (with FRAME SCHEMATIC DIAGRAM)

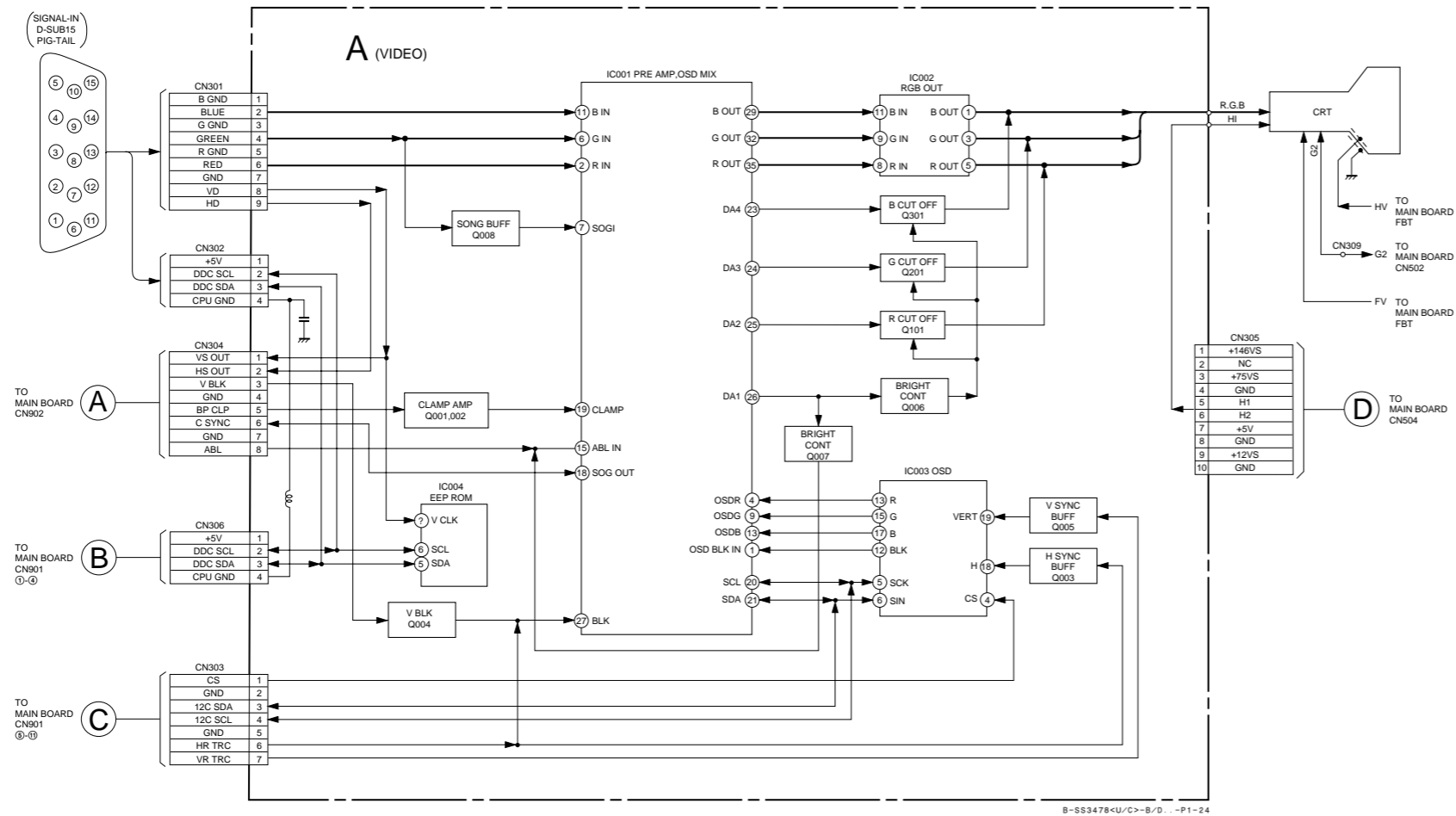

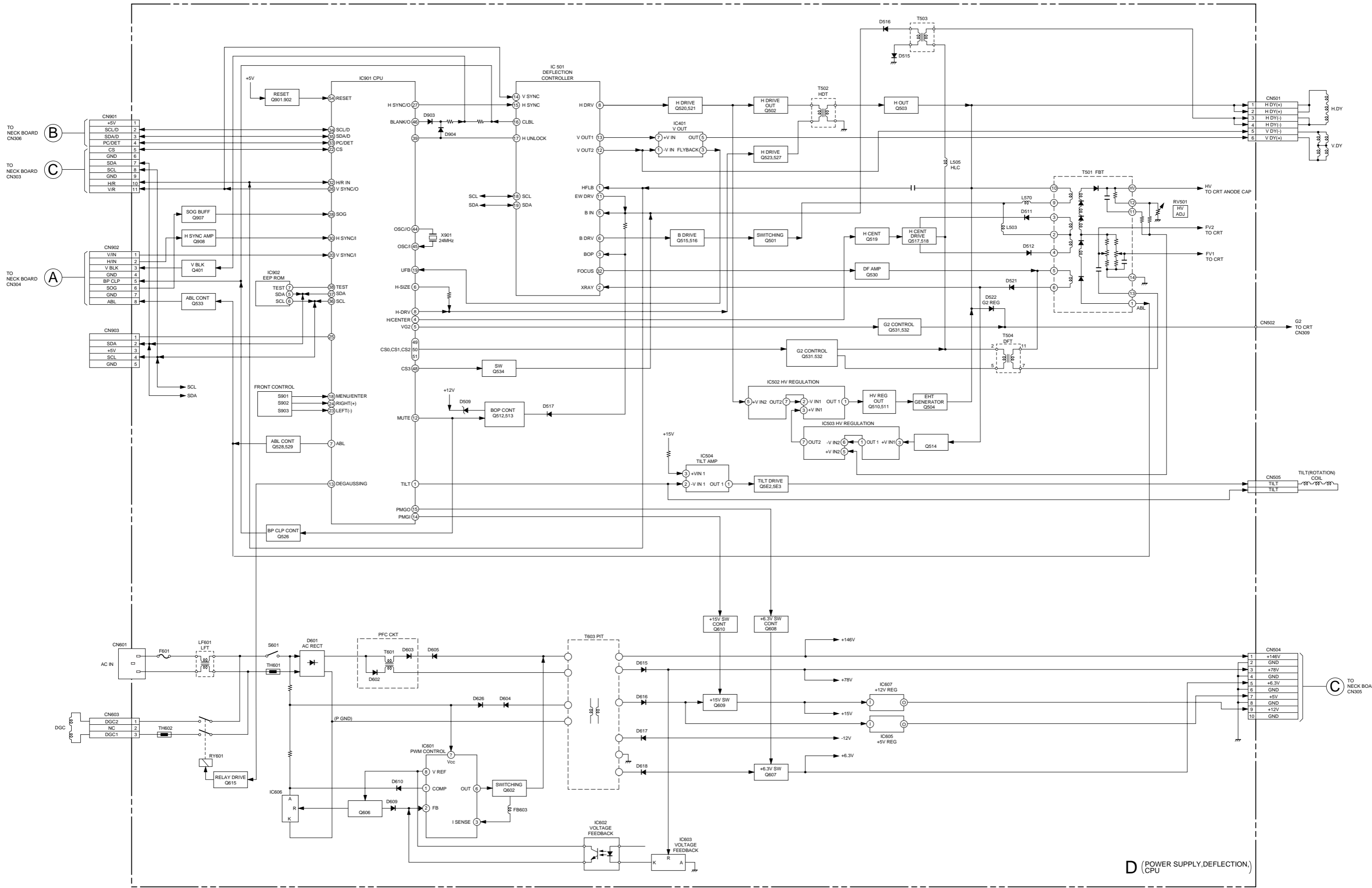

D (POWER SUPPLY, DEFLECTION, CPU)

5-2. CIRCUIT BOARDS LOCATION

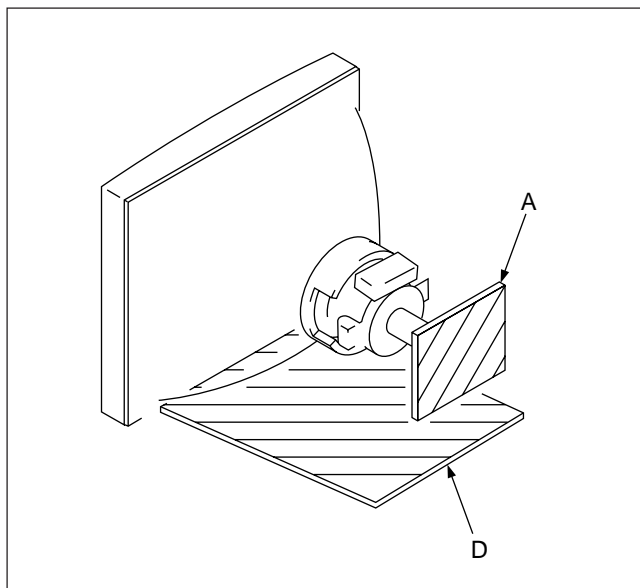







5-3. SCHEMATIC DIAGRAMS AND PRINTED WIRING BOARDS

Note:

- All capacitors are in μF unless otherwise noted. (pF : $\mu\mu\text{F}$)
Capacitors without voltage indication are all 50 V.
- Indication of resistance, which does not have one for rating electrical power, is as follows.

Pitch: 5 mm
Rating electrical power 1/4 W (CHIP : 1/10 W)

- All resistors are in ohms.
-  : nonflammable resistor.
-  : fusible resistor.
- Δ : internal component.
-  : panel designation, and adjustment for repair.
- All variable and adjustable resistors have characteristic curve B, unless otherwise noted.
- \perp : earth-ground.
- /// : earth-chassis.
- All voltages are in V.
- Readings are taken with a 10 M Ω digital multimeter.
- Readings are taken with a color-bar signal input.
- Voltage variations may be noted due to normal production tolerances.
- * : Can not be measured.
- Circled numbers are waveform references.
-  : B + bus.
-  : B - bus.
- The components identified by  in this basic schematic diagram have been carefully factory-selected for each set in order to satisfy regulations regarding X-ray radiation. Should replacement be required, replace only with the value originally used.
- When replacing components identified by  , make the necessary adjustments indicated. (See page 3-1)
- When replacing the part in below table, be sure to perform the related adjustment.

- Divided circuit diagram

One sheet of D board circuit diagram is divided into three sheets, each having the code D-a to D-c . For example, the destination (ab1) on the D-a sheet is connected to (ab1) on the D-b sheet.

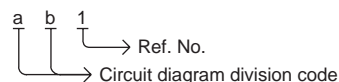

	Part replaced ()
HV ADJ	RV501

	Part replaced ()	
HV Regulator Circuit Check	D Board	IC502, IC503, C501 C535, C553, C597 C598, R592, R593 R596, RV501, T501 (FBT)
HV Hold-down Circuit Check	D Board	IC501, D521, C585 C599, R598, R599 R5C7, T501 (FBT)
Beam Current Protector Circuit Check	D Board	Q533, D592, C590 C591, C598, R5A5 R5C0, R5C3, L502 T501 (FBT)

Note: The components identified by shading and mark Δ are critical for safety. Replace only with part number specified.

Note: Les composants identifiés per un tramé et une marque Δ sont critiques pour la sécurité. Ne les remplacer que par une pièce portant le numéro spécifié.

- Divided circuit diagram

One sheet of D board circuit diagram is divided into three sheets, each having the code D-a to D-c . For example, the destination (ab1) on the D-a sheet is connected to (ab1) on the D-b sheet.

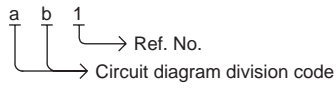

- D BOARD WAVEFORMS

① 3.0 Vp-p (H)	② 3.0 Vp-p (H)	③ 3.4 Vp-p (H)
④ 4.8 Vp-p (V)	⑤ 5.0 Vp-p (H)	⑥ 1.2 Vp-p (24MHz)
⑦ 5.0 Vp-p (H)	⑧ 5.0 Vp-p (V)	⑨ 2.8 Vp-p (V)
⑩ 2.0 Vp-p (V)	⑪ 12.0 Vp-p (H)	⑫ 50.0 Vp-p (V)
⑬ 1.2 Vp-p (V)	⑭ 1k Vp-p (H)	⑰ 60.0 Vp-p (H)
⑰ 12.0 Vp-p (H)	⑱ 100 Vp-p (H)	

(1) Schematic Diagram of D-a Board

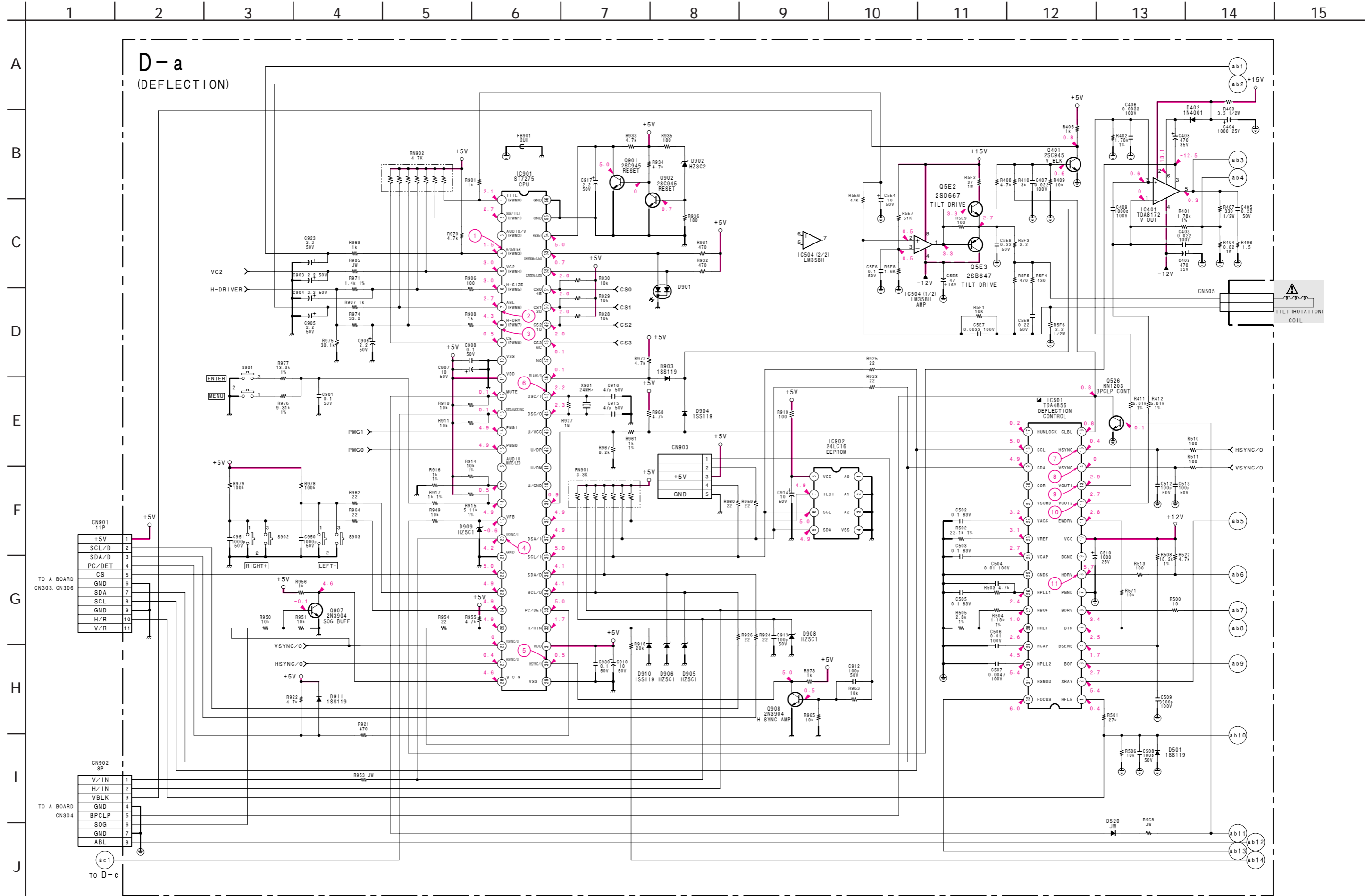

(2) Schematic Diagram of D-b Board

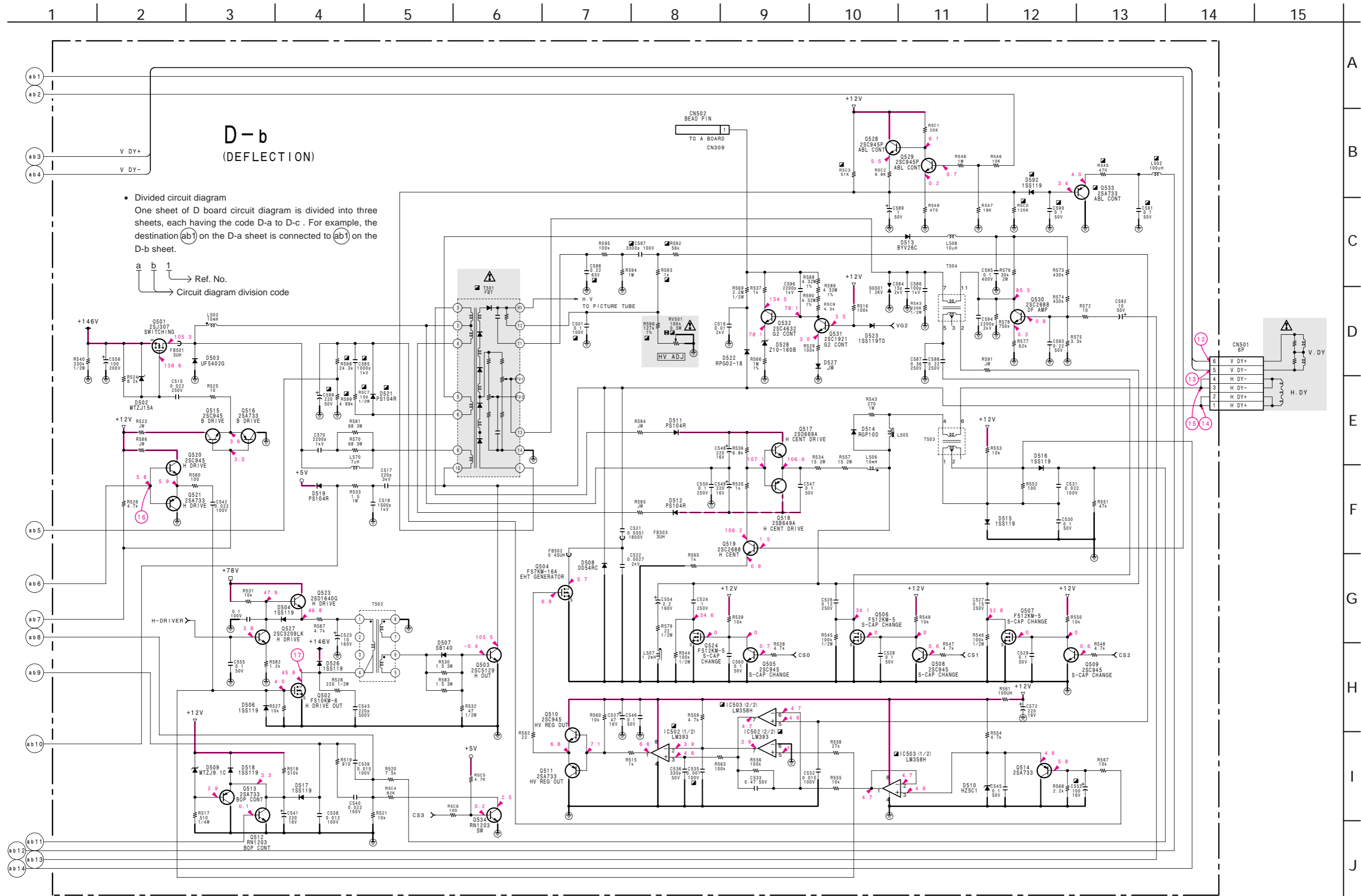

• D BOARD SEMICONDUCTOR LOCATION

IC		DIODE	
IC401	E-3	D402	E-4
IC501	D-6	D501	D-5
IC502	D-1	D502	C-2
IC503	D-1	D503	C-2
IC504	D-5	D504	C-4
IC601	A-4	D506	D-3
IC602	A-4	D507	D-3
IC603	A-4	D508	C-3
IC605	A-5	D509	D-5
IC606	A-4	D510	D-1
IC607	A-5	D511	C-1
IC901	B-6	D512	C-1
IC902	C-6	D513	D-1
		D514	D-4
		D515	C-3
		D516	C-3
		D517	D-6
		D518	D-5
		D519	D-5
		D520	D-6
		D521	D-1
		D522	D-2
		D523	C-4
		D524	E-1
		D601	A-2
		D604	A-3
		D605	A-3
		D606	A-3
		D607	A-2
		D608	A-4
		D609	A-4
		D610	A-3
		D611	B-1
		D612	A-4
		D613	B-3
		D615	B-3
		D616	B-4
		D617	B-4
		D618	B-4
		D626	A-3
		D901	A-6
		D902	C-6
		D903	C-6
		D904	E-6
		D905	C-5
		D906	C-5
		D907	C-5
		D908	C-5
		D909	B-5
		D910	C-5
TRANSISTOR		VARIABLE RESISTOR	
Q401	E-4	RV501	E-1
Q501	C-2		
Q502	D-3		
Q503	D-3		
Q504	C-2		
Q505	C-4		
Q506	D-4		
Q507	D-4		
Q508	D-4		
Q509	D-4		
Q510	D-1		
Q511	D-1		
Q512	D-6		
Q513	D-5		
Q514	E-1		
Q515	D-5		
Q516	D-5		
Q517	B-1		
Q518	C-1		
Q519	C-1		
Q520	D-5		
Q521	D-5		
Q523	C-4		
Q524	C-4		
Q526	E-6		
Q527	C-4		
Q528	C-1		
Q529	C-3		
Q530	D-1		
Q531	C-2		
Q532	C-2		
Q533	E-1		
Q534	D-6		
Q5E2	D-5		
Q5E3	D-5		
Q601	A-4		
Q602	A-3		
Q607	B-4		
Q608	A-4		
Q609	B-5		
Q610	B-5		
Q615	B-1		
Q901	C-6		
Q902	C-6		
Q907	C-5		
Q908	C-5		
		CRYSTAL	
		X901	C-6

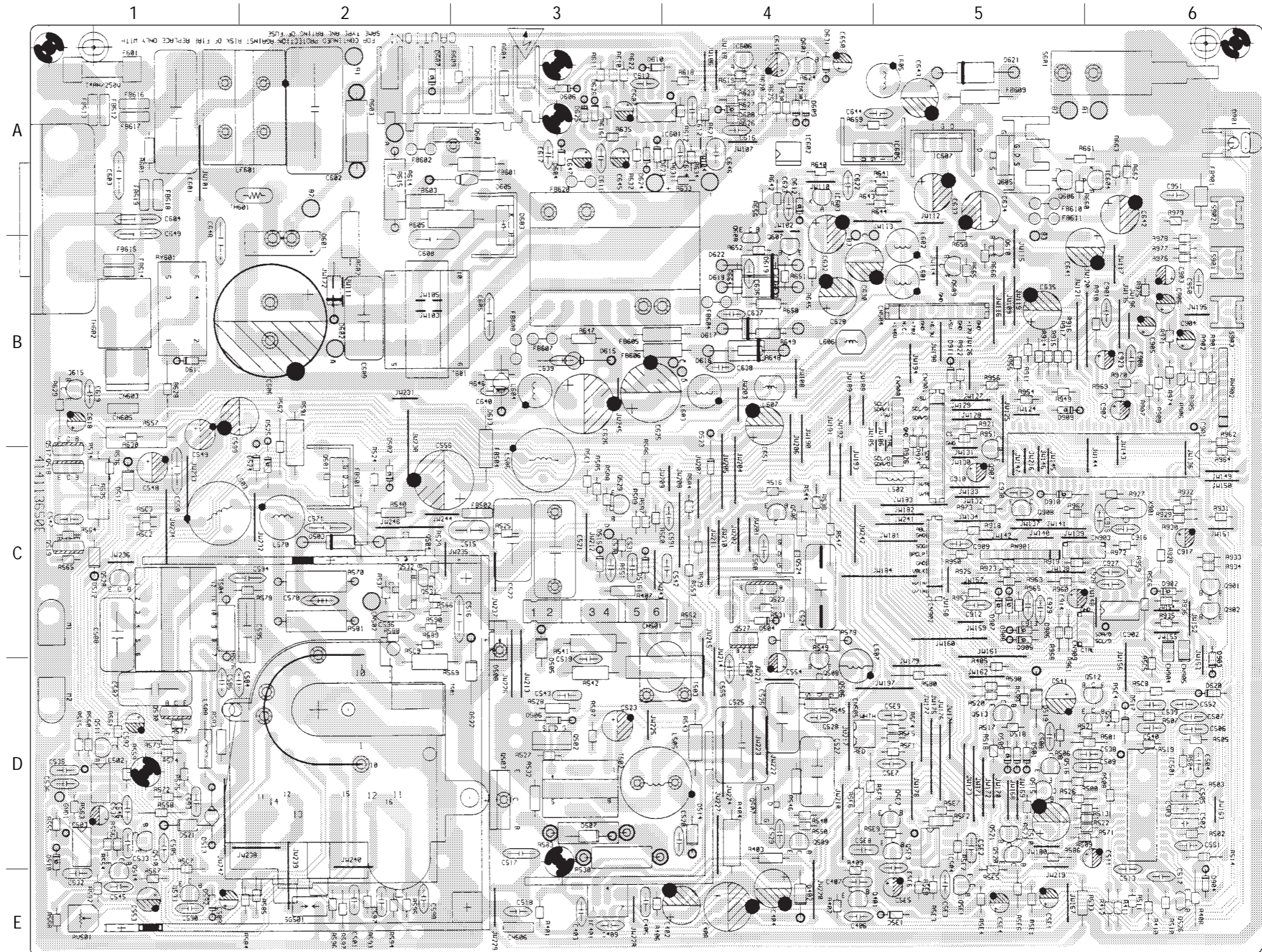

(3) Schematic Diagram of D-c Board

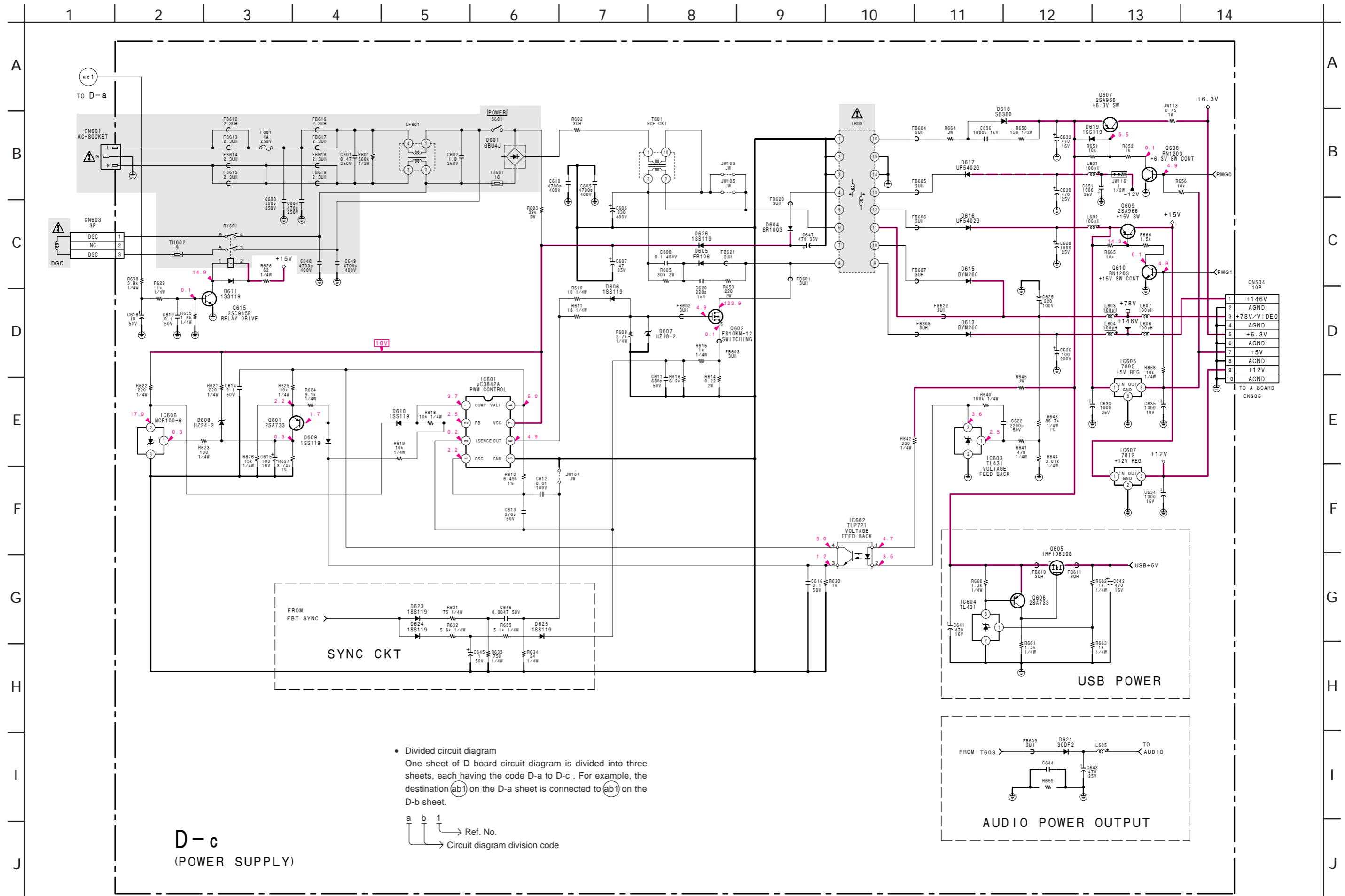

D-c
(POWER SUPPLY)

- Divided circuit diagram
One sheet of D board circuit diagram is divided into three sheets, each having the code D-a to D-c . For example, the destination (ab1) on the D-a sheet is connected to (ab1) on the D-b sheet.

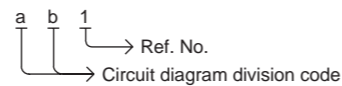

— A BOARD (Conductor Side) —

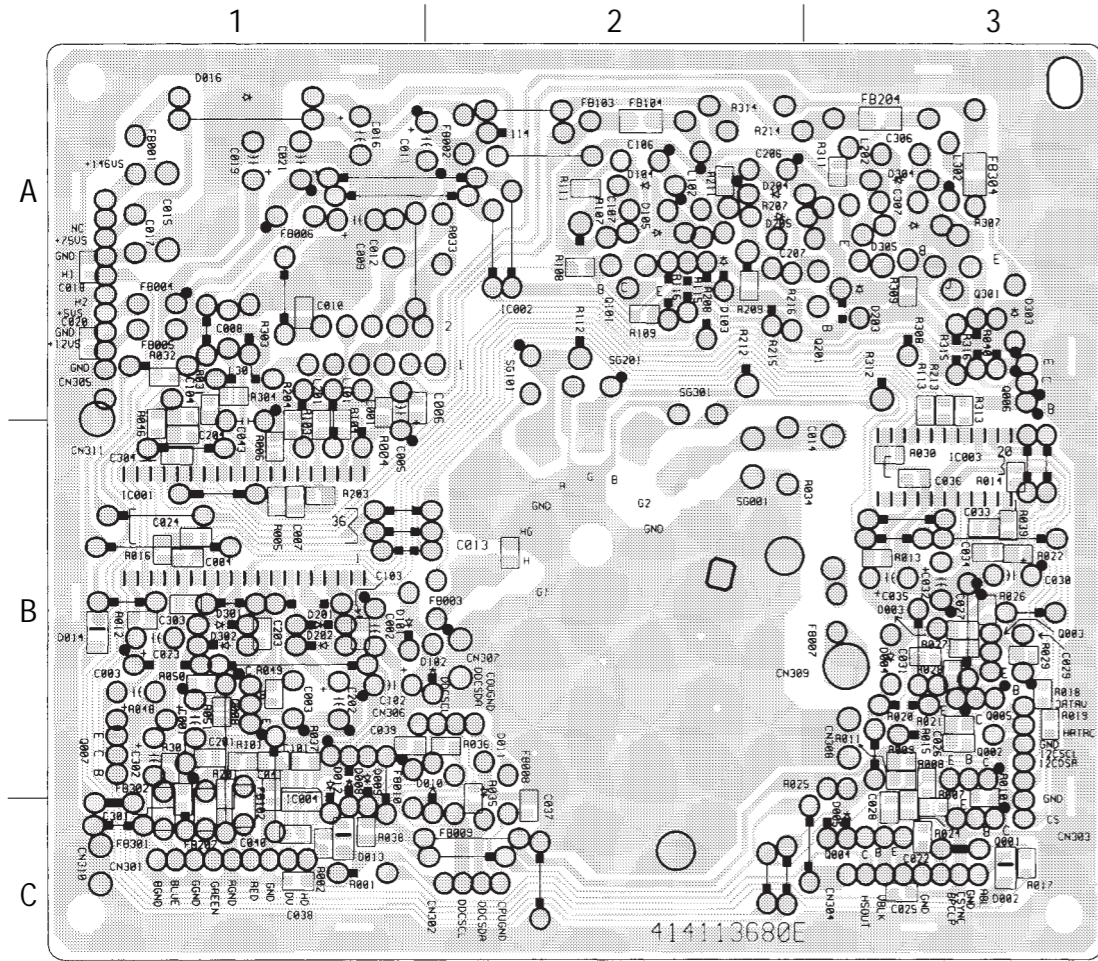

• A BOARD SEMICONDUCTOR LOCATION

IC	(Conductor Side)	(Component Side)
	IC001	B-1
IC002	A-1	B-3
IC003	B-3	B-1
IC004	B-1	B-3

TRANSISTOR	(Conductor Side)	(Component Side)
	Q001	C-3
Q002	B-3	B-1
Q003	B-3	B-1
Q004	C-3	C-1
Q005	B-3	B-1
Q006	A-3	A-1
Q007	B-1	B-3
Q008	B-1	B-3
Q101	A-2	A-2
Q201	A-2	A-2
Q301	A-3	A-1

DIODE	(Conductor Side)	(Component Side)
	D002	C-3
D003	B-3	B-1
D004	B-3	B-1
D005	C-3	C-1
D008	B-1	B-2
D009	B-1	B-2
D010	B-1	B-2
D011	B-2	B-2
D012	B-1	B-3
D013	C-1	B-1
D016	A-1	A-3
D101	B-1	B-2
D102	B-1	B-2
D103	A-2	A-1
D104	A-2	A-2
D105	A-2	A-2
D201	B-1	B-3
D202	B-1	B-3
D203	A-3	A-1
D204	A-2	A-1
D205	A-2	A-1
D301	B-1	B-3
D302	B-1	B-3
D303	A-3	A-1
D304	A-3	A-1
D305	A-3	A-1

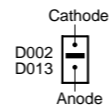

— A BOARD (Component Side) —

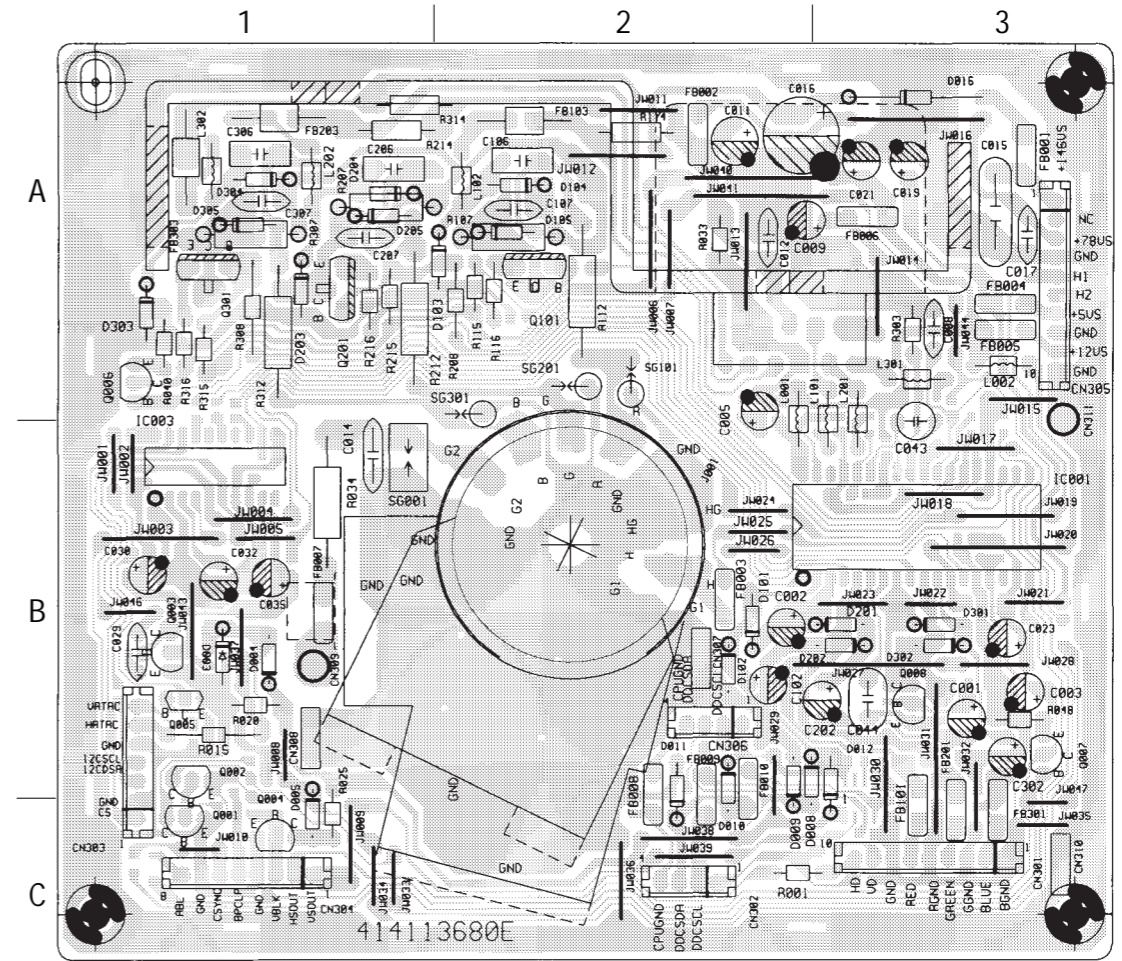

• Pattern of the rear side.

(4) Schematic Diagram of A Board

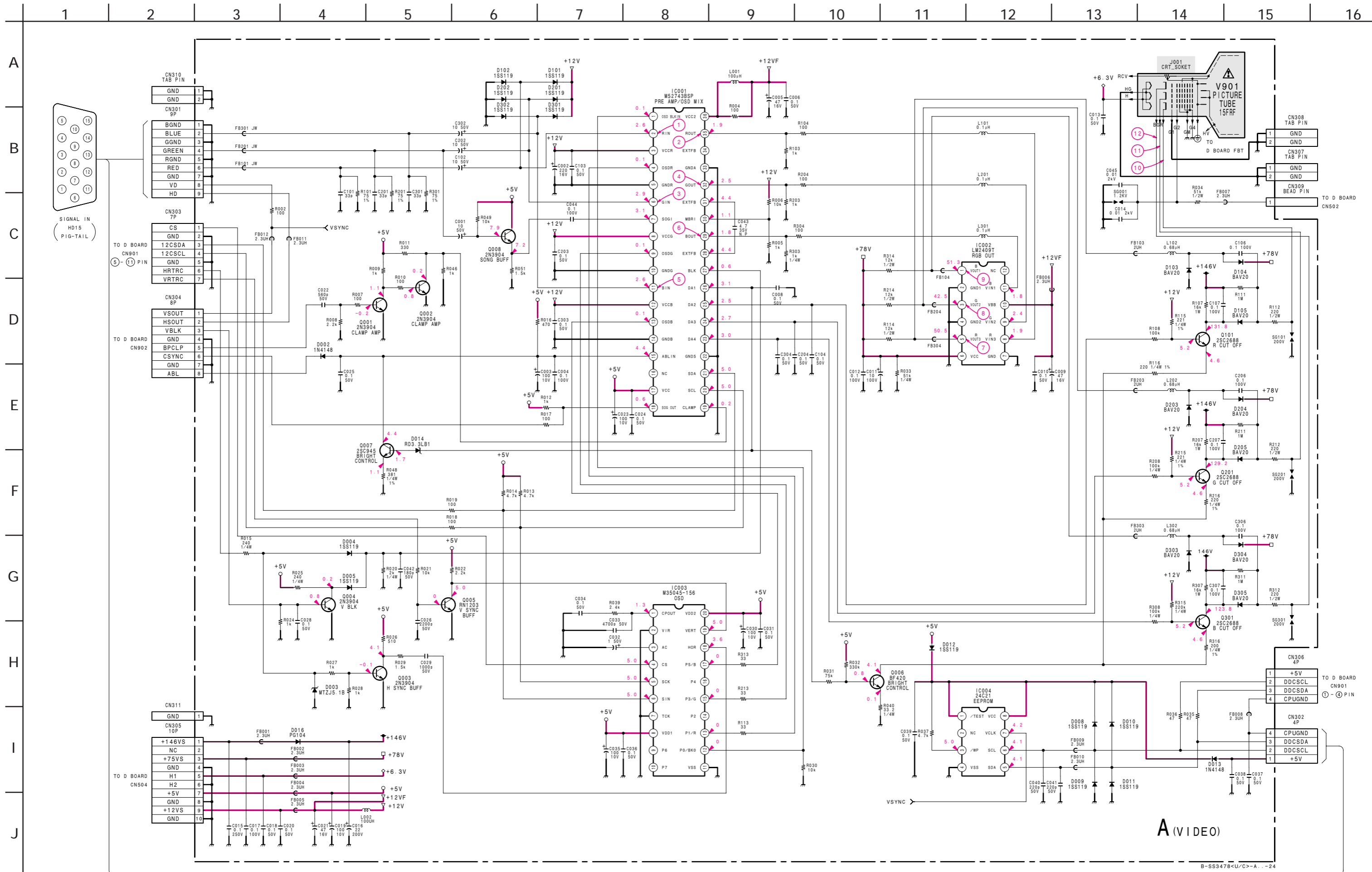

A (VIDEO)

B-SS3478<U/C>-A...-24

• A BOARD WAVEFORMS

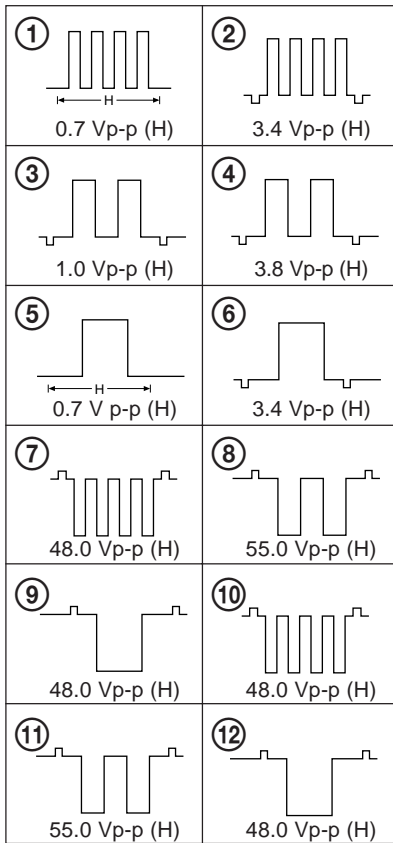

5-4. SEMICONDUCTORS

LM2409

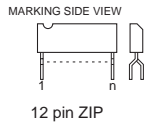

LM358M
LM393M
24LC16BT/SN
24LC21T/SN

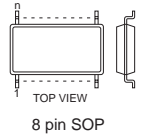

MCT7812CT
TA7805S

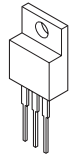

M35045

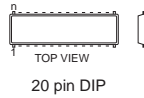

M52743BSP

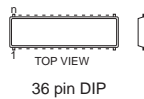

PC123F2

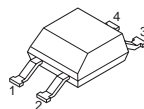

ST72T75

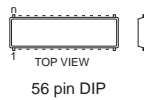

TDA4856

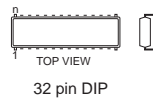

TDA8172

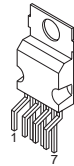

TL431

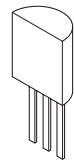

uC3842A

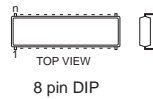

DTC124ESA

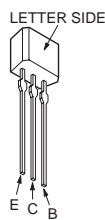

FS10KM-6
FS10KM-12
FS12KM-5
FS7KM-16A
2SJ449

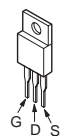

IRFI9620G

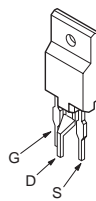

2N3904

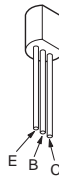

2SA1221-L
2SC3209LK



2SA733-Q
2SC945-P



2SB649A
2SC2688-LK
2SD1640Q,R
2SD669A-C

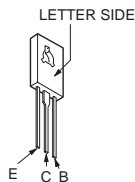

2SC1921

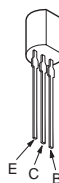

2SC2383-O

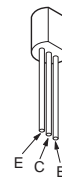

2SC4632LS-CB7

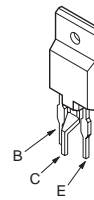

2SC5129

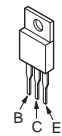

DD54RC

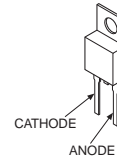

GBU4J

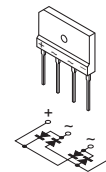

HZ18-2
MTZJ-T-73-15A
SB140
1N4001
1N4148
31DF6

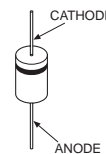

MTZJ-5.1A
MTZJ-5.1B
RD3.3ESB2
RD5.1ESB2
RD9.1ESB3
1SS119-25

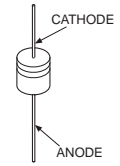

RD3.3LB1

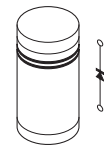

RGP02-18
RH-1A
30DF2

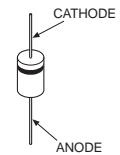

SECTION 6 EXPLODED VIEWS

NOTE:

- Items with no part number and no description are not stocked because they are seldom required for routine service.
- The construction parts of an assembled part are indicated with a collation number in the remark column.
- Items marked " * " are not stocked since they are seldom required for routine service. Some delay should be anticipated when ordering these items.

The components identified by shading and mark Δ are critical for safety. Replace only with part number specified.

Les composants identifiés par un tramé et une marque Δ sont critiques pour la sécurité. Ne les remplacer que par une pièce portant le numéro spécifié.

6-1. CHASSIS

- 7-685-648-79 +BVTP 3X12
- 7-685-663-71 +BVTP 4X16
- ◆ 7-685-881-09 +BVTT 4X8

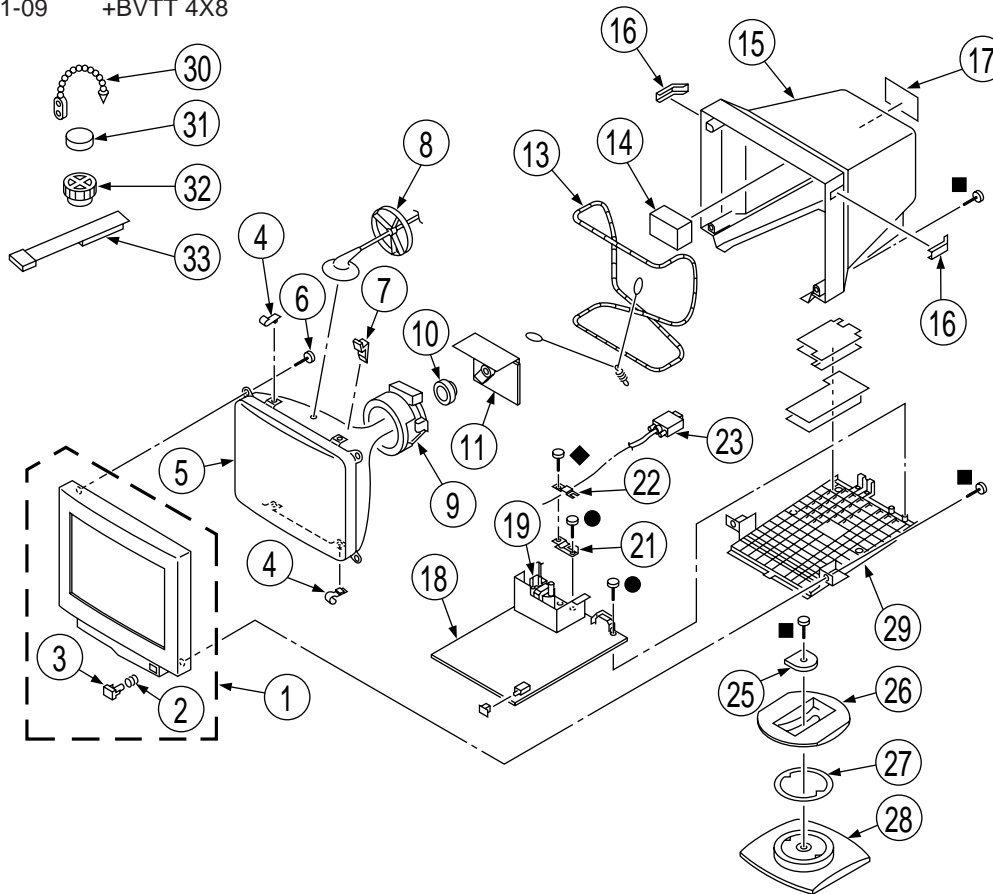

REF.NO.	PART NO.	DESCRIPTION	REMARK	REF.NO.	PART NO.	DESCRIPTION	REMARK
1	X-4036-502-1	BEZEL ASSY (110GS)	2,3	17	4-069-052-01	LABEL, INFORMATION (110GS)	
1	X-4036-566-1	BEZEL ASSY (110EST)	2,3	17	4-069-052-21	LABEL, INFORMATION (110EST)	
2	4-060-162-01	SPRING, COMPRESSION		18	* A-1343-657-A	D BOARD, COMPLETE	19
3	4-060-157-01	BUTTON, POWER (110GS)		19	Δ 1-453-301-11	TRANSFORMER, FLYBACK	
3	4-060-157-11	BUTTON, POWER (110EST)		21	* 4-060-150-01	BRACKET, CABLE	
4	4-045-123-01	HOLDER, DEGAUSSING COIL		22	* 4-060-151-01	STOPPER, CABLE	
5	Δ 8-734-832-05	PICTURE TUBE (15FRF)(MIZ)		23	1-790-576-11	CABLE ASSY (I/O)	
6	4-365-808-01	SCREW (5), TAPPING		25	* 4-060-183-01	STOPPER (A)	
7	4-060-166-01	SPACER, DY		26	4-060-179-01	SLIDER (110GS)	
8	4-060-155-01	HOLDER, HV CABLE		26	4-060-613-01	SLIDER (110EST)	
9	Δ 8-451-469-21	DEFLECTION YOKE (Y15FRF2M2)		27	* 4-060-180-01	RING, TILT SWIVEL	
10	Δ 1-452-756-11	NECK ASSY (NA293)		28	* X-4034-791-1	BASE ASSY, STAND (110GS)	
11	* A-1294-563-A	A BOARD, COMPLETE		28	* X-4034-879-1	BASE ASSY, STAND (110EST)	
13	Δ 1-409-799-11	COIL, DEMAGNETIC		29	* 4-060-177-01	COVER, BOTTOM (110GS)	
14	* 4-060-175-01	CUSHION, A BOARD		29	4-060-612-21	COVER, BOTTOM (110EST)	
15	4-060-149-01	CABINET (110GS)		30	4-308-870-00	CLIP, LEAD WIRE	
15	4-060-149-11	CABINET (110EST)		31	1-452-032-00	MAGNET, DISC ; 10mmø	
16	4-060-165-01	COVER, SCREW (110GS)		32	1-452-094-00	MAGNET, ROTATABLE DISK ; 15mmø	
16	4-060-165-21	COVER, SCREW (110EST)		33	* X-4034-792-1	PERMALLOY ASSY	

CPD-110GS/110EST

The components identified by shading and mark \triangle are critical for safety. Replace only with part number specified.

Les composants identifiés par un tramé et une marque \triangle sont critiques pour la sécurité. Ne les remplacer que par une pièce portant le numéro spécifié.

6-2. PACKING MATERIALS

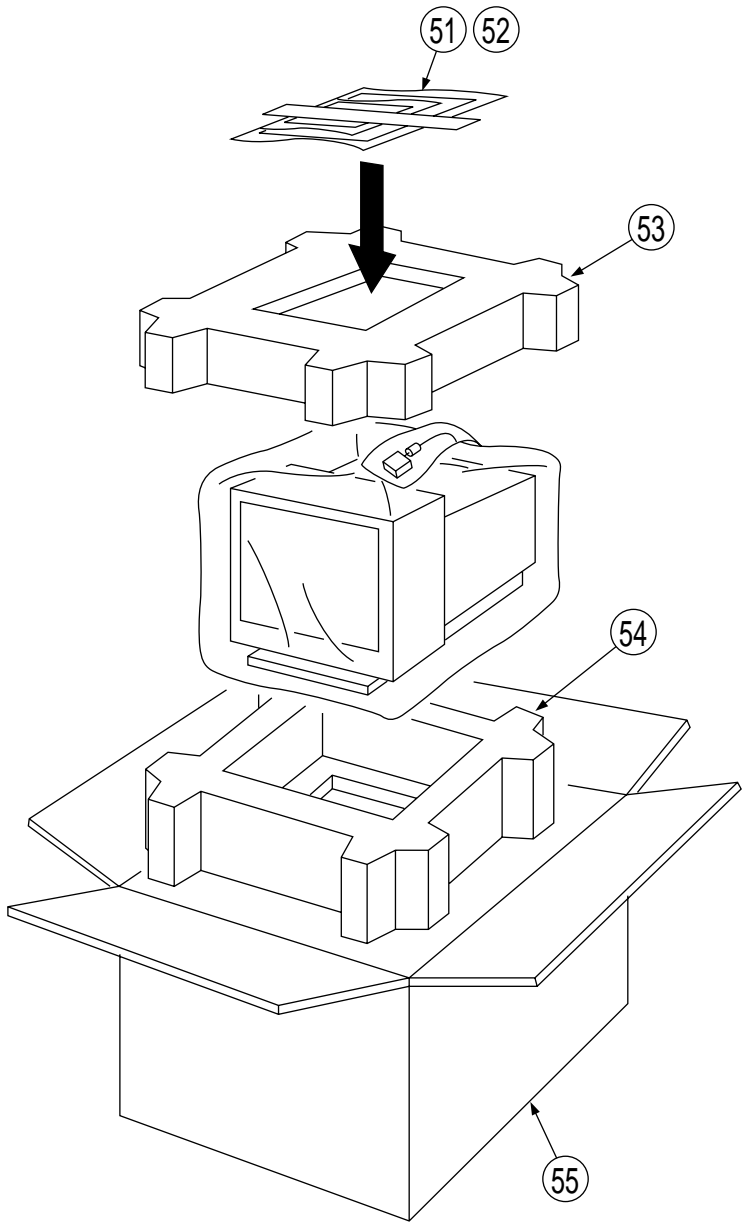

REF.NO.	PART NO.	DESCRIPTION	REMARK	REF.NO.	PART NO.	DESCRIPTION	REMARK
51	\triangle 1-765-719-11	CORD SET, POWER (110EST)		53	* 4-060-187-01	CUSHION (UPPER)	
51	\triangle 1-776-027-41	CORD SET, POWER (110GS)		54	* 4-060-192-01	CUSHION (LOWER)	
52	3-865-633-11	MANUAL, INSTRUCTION (110EST)		55	* 4-069-228-01	INDIVIDUAL CARTON (110GS)	
52	3-865-633-21	MANUAL, INSTRUCTION (110GS)		55	* 4-069-229-01	INDIVIDUAL CARTON (110EST)	

SECTION 7 ELECTRICAL PARTS LIST



NOTE:

The components identified by mark Δ are critical for safety. Replace only with part number specified.

Les composants identifiés par une marque Δ sont critiques pour la sécurité. Ne les remplacer que par une pièce portant le numéro spécifié.

When indicating parts by reference number, please include the board name.

The components identified by \boxtimes in this manual have been carefully factory-selected for each set in order to satisfy regulations regarding X-ray radiation. Should replacement be required, replace only with the value originally used.

- All variable and adjustable resistors have characteristic curve B, unless otherwise noted.

RESISTORS

- All resistors are in ohms
- F : nonflammable
- Items marked " * " are not stocked since they are seldom required for routine service. Some delay should be anticipated when ordering these items.

CAPACITORS

MF : μ F

COILS

UH : μ H

REF.NO.	PART NO.	DESCRIPTION	REMARK	REF.NO.	PART NO.	DESCRIPTION	REMARK
	* A-1294-563-A	A BOARD, COMPLETE *****		C039	1-115-339-11	CERAMIC CHIP 0.1MF	10% 50V
	4-382-854-01	SCREW (M3X8), P, SW (+) (IC002)		C040	1-163-125-00	CERAMIC CHIP 220PF	5% 50V
	<CAPACITOR>			C041	1-163-125-00	CERAMIC CHIP 220PF	5% 50V
C001	1-126-964-11	ELECT 10MF	20% 50V	C043	1-107-713-11	ELECT 4.7MF	20% 35V
C002	1-104-664-11	ELECT 470MF	20% 25V	C044		0.1MF	100V
C003	1-126-933-11	ELECT 100MF	20% 16V	C101	1-163-894-91	CERAMIC CHIP 7PF	0.5PF 50V
C004	1-136-189-00	FILM 0.1MF	10% 250V	C102	1-126-964-11	ELECT 10MF	20% 50V
C005	1-104-664-11	ELECT 47MF	20% 25V	C103	1-115-339-11	CERAMIC CHIP 0.1MF	10% 50V
C006	1-115-339-11	CERAMIC CHIP 0.1MF	10% 50V	C104	1-115-339-11	CERAMIC CHIP 0.1MF	10% 50V
C008	1-136-165-00	FILM 0.1MF	5% 50V	C106	1-136-189-00	FILM 0.1MF	10% 250V
C009	1-104-664-11	ELECT 47MF	20% 25V	C107	1-127-980-11	CERAMIC 0.1MF	0 100V
C010	1-115-339-11	CERAMIC CHIP 0.1MF	10% 50V	C201	1-163-105-00	CERAMIC CHIP 33PF	5% 50V
C011	1-128-582-11	ELECT 10MF	20% 100V	C202	1-126-964-11	ELECT 10MF	20% 50V
C012	1-127-980-11	CERAMIC 0.1MF	0 100V	C203	1-115-339-11	CERAMIC CHIP 0.1MF	10% 50V
C013	1-115-339-11	CERAMIC CHIP 0.1MF	10% 50V	C204	1-115-339-11	CERAMIC CHIP 0.1MF	10% 50V
C014	1-115-349-51	CERAMIC 0.01MF	2KV	C206	1-136-189-00	FILM 0.1MF	10% 250V
C015	1-137-528-11	FILM 0.1MF	10% 250V	C207	1-127-980-11	CERAMIC 0.1MF	0 100V
C016	1-107-645-11	ELECT 22MF	20% 200V	C301	1-163-105-00	CERAMIC CHIP 33PF	5% 50V
C017	1-127-980-11	CERAMIC 0.1MF	0 100V	C302	1-126-964-11	ELECT 10MF	20% 50V
C018	1-115-339-11	CERAMIC CHIP 0.1MF	10% 50V	C303	1-115-339-11	CERAMIC CHIP 0.1MF	10% 50V
C019	1-126-933-11	ELECT 100MF	20% 16V	C304	1-115-339-11	CERAMIC CHIP 0.1MF	10% 50V
C020	1-115-339-11	CERAMIC CHIP 0.1MF	10% 50V	C306	1-136-189-00	FILM 0.1MF	10% 250V
C021	1-104-664-11	ELECT 47MF	20% 25V	C307	1-127-980-11	CERAMIC 0.1MF	0 100V
C022	1-163-199-00	CERAMIC CHIP 560PF	5% 50V	<CONNECTOR>			
C023	1-126-933-11	ELECT 100MF	20% 16V	CN301*	1-564-512-11	PLUG, CONNECTOR 9P	
C024	1-115-339-11	CERAMIC CHIP 0.1MF	10% 50V	CN302*	1-564-507-11	PLUG, CONNECTOR 4P	
C025	1-115-339-11	CERAMIC CHIP 0.1MF	10% 50V	CN303*	1-564-510-11	PLUG, CONNECTOR 7P	
C026	1-164-161-11	CERAMIC CHIP 0.0022MF	10% 50V	CN304*	1-564-511-11	PLUG, CONNECTOR 8P	
C028	1-115-339-11	CERAMIC CHIP 0.1MF	10% 50V	CN305	1-564-513-11	OUTPUT CORD	
C029	1-102-074-00	CERAMIC 0.001MF	10% 50V	CN306*	1-564-507-11	PLUG, CONNECTOR 4P	
C030	1-126-933-11	ELECT 100MF	20% 16V	CN307	1-695-915-11	TAB (CONTACT)	
C031	1-115-339-11	CERAMIC CHIP 0.1MF	10% 50V	CN308	1-695-915-11	TAB (CONTACT)	
C032	1-126-960-11	ELECT 1MF	20% 50V	CN309	1-506-108-41	PIN, CONNECTOR (TERMINAL PIN)	
C033	1-163-017-00	CERAMIC CHIP 0.0047MF	10% 50V	CN310	1-695-915-11	TAB (CONTACT)	
C034	1-115-339-11	CERAMIC CHIP 0.1MF	10% 50V	<DIODE>			
C035	1-126-933-11	ELECT 100MF	20% 16V	D002	8-719-070-90	DIODE 1N4148	
C036	1-115-339-11	CERAMIC CHIP 0.1MF	10% 50V	D003	8-719-921-42	ZENER DIODE MTZJ-5.1A	
C037	1-115-339-11	CERAMIC CHIP 0.1MF	10% 50V	D004	8-719-900-23	DIODE GL-2AR1	
C038	1-115-339-11	CERAMIC CHIP 0.1MF	10% 50V	D005	8-719-900-23	DIODE GL-2AR1	
				D008	8-719-900-23	DIODE GL-2AR1	

CPD-110GS/110EST



Les composants identifiés par une
marque Δ sont critiques pour la sécurité.
Ne les remplacer que par une pièce
portant le numéro spécifié.

The components identified by mark Δ
are critical for safety.
Replace only with part number specified.

REF.NO.	PART NO.	DESCRIPTION	REMARK	REF.NO.	PART NO.	DESCRIPTION	REMARK
D009	8-719-900-23	DIODE GL-2AR1		<TRANSISTOR>			
D010	8-719-900-23	DIODE GL-2AR1		Q001	8-729-139-04	TRANSISTOR 2N3904	
D011	8-719-900-23	DIODE GL-2AR1		Q002	8-729-139-04	TRANSISTOR 2N3904	
D012	8-719-900-23	DIODE GL-2AR1		Q003	8-729-139-04	TRANSISTOR 2N3904	
D013	8-719-070-90	DIODE 1N4148		Q004	8-729-139-04	TRANSISTOR 2N3904	
D014	8-719-109-66	ZENER DIODE RD3.3ESB2		Q005	8-729-029-86	TRANSISTOR DTC124ESA	
D016	8-719-074-25	DIODE RGP10D		Q006	8-729-048-20	TRANSISTOR BF420	
D101	8-719-900-23	DIODE GL-2AR1		Q007	9-910-999-34	TRANSISTOR 2SC945-P	
D102	8-719-900-23	DIODE GL-2AR1		Q008	8-729-139-04	TRANSISTOR 2N3904	
D103	8-719-074-15	DIODE BAV20		Q101	8-729-119-80	TRANSISTOR 2SC2688-LK	
D104	8-719-074-15	DIODE BAV20		Q201	8-729-119-80	TRANSISTOR 2SC2688-LK	
D105	8-719-074-15	DIODE BAV20		Q301	8-729-119-80	TRANSISTOR 2SC2688-LK	
D201	8-719-900-23	DIODE GL-2AR1		<RESISTOR>			
D202	8-719-900-23	DIODE GL-2AR1		R001	1-247-815-91	CARBON	220 5% 1/4W
D203	8-719-074-15	DIODE BAV20		R002	1-216-025-91	RES,CHIP	100 5% 1/10W
D204	8-719-074-15	DIODE BAV20		R004	1-216-025-91	RES,CHIP	100 5% 1/10W
D205	8-719-074-15	DIODE BAV20		R005	1-216-049-91	RES,CHIP	1K 5% 1/10W
D301	8-719-900-23	DIODE GL-2AR1		R006	1-216-073-00	RES,CHIP	10K 5% 1/10W
D302	8-719-900-23	DIODE GL-2AR1		R007	1-216-025-91	RES,CHIP	100 5% 1/10W
D303	8-719-074-15	DIODE BAV20		R008	1-216-057-00	RES,CHIP	2.2K 5% 1/10W
D304	8-719-074-15	DIODE BAV20		R009	1-216-049-91	RES,CHIP	1K 5% 1/10W
D305	8-719-074-15	DIODE BAV20		R010	1-216-025-91	RES,CHIP	100 5% 1/10W
<FERRITE BEAD>				R011	1-216-037-00	RES,CHIP	330 5% 1/10W
FB001	1-412-911-11	FERRITE	2.3UH	R012	1-216-049-91	RES,CHIP	1K 5% 1/10W
FB002	1-412-911-11	FERRITE	2.3UH	R013	1-216-065-00	METAL CHIP	4.7K 5% 1/10W
FB003	1-412-911-11	FERRITE	2.3UH	R014	1-216-065-00	METAL CHIP	4.7K 5% 1/10W
FB004	1-412-911-11	FERRITE	2.3UH	R015	1-247-816-11	CARBON	240 5% 1/4W
FB005	1-412-911-11	FERRITE	2.3UH	R016	1-216-041-11	METAL CHIP	470 5% 1/10W
FB006	1-412-911-11	FERRITE	2.3UH	R017	1-216-025-91	RES,CHIP	100 5% 1/10W
FB007	1-412-911-11	FERRITE	2.3UH	R018	1-216-025-91	RES,CHIP	100 5% 1/10W
FB008	1-412-911-11	FERRITE	2.3UH	R019	1-216-025-91	RES,CHIP	100 5% 1/10W
FB009	1-412-911-11	FERRITE	2.3UH	R020	1-247-838-00	CARBON	2K 5% 1/4W
FB010	1-412-911-11	FERRITE	2.3UH	R021	1-216-061-00	RES,CHIP	3.3K 5% 1/10W
<IC>				R022	1-216-057-00	RES,CHIP	2.2K 5% 1/10W
IC001	8-759-582-06	IC M52743BSP		R024	1-216-049-91	RES,CHIP	1K 5% 1/10W
IC002	8-759-582-08	IC LM2409		R025	1-247-816-11	CARBON	240 5% 1/4W
IC003	8-759-582-07	IC M35045		R026	1-216-042-00	RES,CHIP	510 5% 1/10W
IC004	8-759-370-08	IC 24LC21T/SN		R027	1-216-049-91	RES,CHIP	1K 5% 1/10W
<JACK>				R028	1-216-049-91	RES,CHIP	1K 5% 1/10W
J001	Δ 1-251-335-11	SOCKET, PICTURE TUBE		R029	1-216-053-00	RES,CHIP	1.5K 5% 1/10W
<COIL>				R030	1-216-073-00	RES,CHIP	10K 5% 1/10W
L001	1-469-400-11	INDUCTOR 100UH		R031	1-216-094-00	RES,CHIP	75K 5% 1/10W
L002	1-469-400-11	INDUCTOR 100UH		R032	1-216-109-00	RES,CHIP	330K 5% 1/10W
L101	1-469-398-11	INDUCTOR 0.1UH		R033	1-247-872-11	CARBON	51K 5% 1/4W
L102	1-469-399-11	INDUCTOR 0.68UH		R034	1-260-192-91	CARBON	51K 5% 1/2W
L201		INDUCTOR 0.1UH		R035	1-216-017-00	METAL CHIP	47 5% 1/10W
L202	1-469-399-11	INDUCTOR 0.68UH		R036	1-216-017-00	METAL CHIP	47 5% 1/10W
L301		INDUCTOR 0.1UH		R037	1-216-065-00	METAL CHIP	4.7K 5% 1/10W
L302	1-469-399-11	INDUCTOR 0.68UH		R038	1-216-065-00	METAL CHIP	4.7K 5% 1/10W
				R039	1-216-058-00	RES,CHIP	2.4K 5% 1/10W
				R040	1-240-888-11	METAL	33.2 1% 1/4W
				R046	1-216-049-91	RES,CHIP	1K 5% 1/10W
				R048	1-215-417-00	METAL	680 1% 1/4W



REF.NO.	PART NO.	DESCRIPTION	REMARK	REF.NO.	PART NO.	DESCRIPTION	REMARK
R049	1-216-080-00	RES,CHIP	20K 5% 1/10W	* A-1343-657-A	D BOARD, COMPLETE		
R051	1-216-053-00	RES,CHIP	1.5K 5% 1/10W		*****		
R101	1-216-022-00	RES,CHIP	75 5% 1/10W				
R103	1-216-049-91	RES,CHIP	1K 5% 1/10W		1-500-619-11	INDUCTOR (D503)	
R104	1-216-025-91	RES,CHIP	100 5% 1/10W		1-506-108-41	PIN, CONNECTOR (TERMINAL PIN)	(R603)
R107	1-240-911-11	METAL OXIDE	16K 5% 1W F		1-533-223-11	HOLDER, FUSE (F601)	
R108	1-216-097-91	RES,CHIP	100K 5% 1/10W	* 1-537-738-21	TERMINAL, EARTH		
R111	1-216-121-91	RES,CHIP	1M 5% 1/10W		1-785-907-11	PLUG, CONNECTOR 1P	(R530, R583, R614)
R112	1-260-091-11	CARBON	220 5% 1/2W				
R113	1-216-013-00	RES,CHIP	33 5% 1/10W				
R114	1-260-112-91	CARBON	12K 5% 1/2W	* 1-900-801-67	CONNECTOR ASSY		
R115	1-215-477-00	METAL	221 1% 1/4W		4-045-132-01	HOLDER (A), LED	
R116	1-215-404-00	METAL	220 1% 1/4W		4-060-176-01	COVER, VOLUME 6 MOLD (RV501)	
R201	1-216-022-00	RES,CHIP	75 5% 1/10W		4-382-854-11	SCREW (M3X10), P, SW (+)	(IC401, IC503, IC907, Q501, Q503, Q504, Q523, Q602, D508)
R203	1-216-049-91	RES,CHIP	1K 5% 1/10W		7-685-881-09	SCREW +BVTT 4X8 (S)	
R204	1-216-025-91	RES,CHIP	100 5% 1/10W				
R207	1-240-911-11	METAL OXIDE	16K 5% 1W F				
R208	1-249-441-11	CARBON	100K 5% 1/4W				
R211	1-216-121-91	RES,CHIP	1M 5% 1/10W				
R212	1-260-091-11	CARBON	220 5% 1/2W				
R213	1-216-013-00	RES,CHIP	33 5% 1/10W				
R214	1-260-112-91	CARBON	12K 5% 1/2W				
R215	1-215-477-00	METAL	220K 1% 1/4W				
R216	1-215-404-00	METAL	220 1% 1/4W				
R301	1-216-022-00	RES, CHIP	75 5% 1/10W				
R303	1-249-417-11	CARBON	1K 5% 1/4W				
R304	1-216-025-91	RES,CHIP	100 5% 1/10W				
R307	1-240-911-11	METAL OXIDE	16K 5% 1W F				
R308	1-249-441-11	CARBON	100K 5% 1/4W				
R311	1-216-121-91	RES,CHIP	1M 5% 1/10W				
R312	1-260-091-11	CARBON	220 5% 1/2W				
R313	1-216-013-00	RES,CHIP	33 5% 1/10W				
R314	1-260-112-91	CARBON	12K 5% 1/2W				
R315	1-247-887-00	CARBON	220K 5% 1/4W				
R316	1-215-404-00	METAL	200 1% 1/4W				
		<SPARK GAP>					
SG001	1-519-422-11	GAP, SPARK					
SG101	1-517-499-11	GAP, SPARK					
SG201	1-517-499-11	GAP, SPARK					
SG301	1-517-499-11	GAP, SPARK					

				C402	1-128-528-11	ELECT	470MF 20% 25V
				C403	1-137-393-11	FILM	0.01MF 5% 100V
				C404	1-107-914-11	ELECT	1000MF 20% 25V
				C405	1-137-378-11	FILM	0.22MF 5% 50V
				C406	1-136-298-00	FILM	0.0033MF 5% 100V
				C407	1-137-455-11	FILM	0.012MF 5% 100V
				C408	1-126-951-11	ELECT	470MF 20% 35V
				C409	1-106-343-00	MYLAR	0.001MF 10% 100V
				C5E4	1-126-964-11	ELECT	10MF 20% 50V
				C5E5	1-104-664-11	ELECT	47MF 20% 16V
				C5E6	1-136-165-00	FILM	0.1MF 5% 50V
				C5E7	1-136-298-00	FILM	0.0033MF 5% 100V
				C5E8	1-137-378-11	FILM	0.22MF 5% 50V
				C5E9	1-137-378-11	FILM	0.22MF 5% 50V
				C501	1-137-399-11	FILM	0.1MF 5% 100V
				C502	1-136-165-00	FILM	0.1MF 5% 50V
				C503	1-136-165-00	FILM	0.1MF 5% 50V
				C504	1-137-393-11	FILM	0.01MF 5% 100V
				C505	1-136-165-00	FILM	0.1MF 5% 50V
				C506	1-137-393-11	FILM	0.01MF 5% 100V
				C507	1-137-391-11	FILM	0.0047MF 5% 100V
				C508	1-102-973-00	CERAMIC	100PF 5% 50V
				C509	1-136-298-00	FILM	0.0033MF 5% 100V
				C510	1-107-914-11	ELECT	1000MF 20% 25V
				C512	1-102-973-00	CERAMIC	100PF 5% 50V
				C513	1-102-973-00	CERAMIC	100PF 5% 50V
				C515	1-136-205-11	FILM	0.022MF 5% 400V
				C516	1-115-349-51	CERAMIC	0.01MF 2KV
				C517	1-128-981-11	CERAMIC	220PF 10% 3KV
				C518	1-104-331-11	CERAMIC	0.0022MF 10% 1KV
				C521	1-107-864-11	FILM	0.0051MF 3% 2.5KV
				C522	1-136-539-11	FILM	0.0022MF 3% 2KV
				C523	1-128-582-11	ELECT	10MF 20% 100V
				C524	1-115-522-11	FILM	1MF 5% 250V
				C525	1-127-979-11	MYLAR	0.36MF 5% 400V
				C526	1-115-511-11	FILM	0.12MF 5% 250V
				C527	1-115-512-11	FILM	0.15MF 5% 250V

CPD-110GS/110EST



Les composants identifiés par une
marque Δ sont critiques pour la sécurité.
Ne les remplacer que par une pièce
portant le numéro spécifié.

The components identified by mark Δ
are critical for safety.
Replace only with part number specified.

REF.NO.	PART NO.	DESCRIPTION	REMARK	REF.NO.	PART NO.	DESCRIPTION	REMARK
C528	1-136-165-00	FILM	0.1MF 5% 50V	C616	1-136-165-00	FILM	0.1MF 5% 50V
C529	1-136-165-00	FILM	0.1MF 5% 50V	C618	1-126-964-11	ELECT	10MF 20% 50V
C530	1-136-165-00	FILM	0.1MF 5% 50V	C619	1-136-165-00	FILM	0.1MF 5% 50V
C531	1-137-395-91	FILM	0.022MF 5% 100V	C620	1-128-982-11	CERAMIC	330PF 1KV
C532	1-136-298-00	FILM	0.0033MF 5% 100V	C622	1-102-121-00	CERAMIC	0.0022MF 10% 50V
C533	1-137-378-11	FILM	0.22MF 5% 50V	C623	1-136-165-00	FILM	0.1MF 5% 50V
C535	1-106-343-00	MYLAR	0.001MF 10% 100V	C625	1-125-700-11	ELECT (BLOCK)	220MF 20% 200V
C536	1-102-112-00	CERAMIC	330PF 10% 50V	C626	1-107-955-11	ELECT	100MF 20% 200V
C537	1-104-664-11	ELECT	47MF 20% 16V	C628	1-107-914-11	ELECT	1000MF 20% 25V
C538	1-137-455-11	FILM	0.012MF 5% 100V	C630	1-128-528-11	ELECT	470MF 20% 25V
C539	1-137-350-11	FILM	0.015MF 5% 100V	C632	1-126-935-11	ELECT	470MF 20% 16V
C540	1-137-464-11	FILM	0.039MF 5% 100V	C633	1-107-914-11	ELECT	1000MF 20% 25V
C541	1-126-934-11	ELECT	220MF 20% 16V	C634	1-107-884-11	ELECT	1000MF 20% 16V
C542	1-137-395-91	FILM	0.022MF 5% 100V	C635	1-126-926-11	ELECT	1000MF 20% 10V
C543	1-102-244-00	CERAMIC	220PF 10% 500V	C636	1-164-143-11	CERAMIC	0.001MF 10% 1KV
C545	1-136-165-00	FILM	0.1MF 5% 50V	C647	1-126-947-11	ELECT	47MF 20% 35V
C546	1-136-165-00	FILM	0.1MF 5% 50V	C648 Δ	1-113-924-91	CERAMIC	0.0047MF 20% 250V
C547	1-130-495-00	FILM	0.1MF 5% 50V	C649 Δ	1-113-924-91	CERAMIC	0.0047MF 20% 250V
C548	1-126-934-11	ELECT	220MF 20% 16V	C651	1-107-914-11	ELECT	1000MF 20% 25V
C549	1-126-934-11	ELECT	220MF 20% 16V	C901	1-136-165-00	FILM	0.1MF 5% 50V
C550	1-128-986-11	FILM	0.01MF 5% 250V	C903	1-126-961-11	ELECT	2.2MF 20% 50V
C553	1-104-664-11	ELECT	47MF 20% 16V	C904	1-126-961-11	ELECT	2.2MF 20% 50V
C554	1-107-667-11	ELECT	2.2MF 20% 160V	C905	1-126-961-11	ELECT	2.2MF 20% 50V
C555	1-136-165-00	FILM	0.1MF 5% 50V	C906	1-126-961-11	ELECT	2.2MF 20% 50V
C556	1-107-955-11	ELECT	100MF 20% 200V	C907	1-126-964-11	ELECT	10MF 20% 50V
C560	1-136-165-00	FILM	0.1MF 5% 50V	C908	1-136-165-00	FILM	0.1MF 5% 50V
C570	1-104-331-11	CERAMIC	0.0022MF 10% 1KV	C910	1-126-964-11	ELECT	10MF 20% 50V
C584	1-109-878-11	CERAMIC	15PF 5% 2KV	C912	1-102-112-00	CERAMIC	330PF 10% 50V
C585	1-164-143-11	CERAMIC	0.001MF 10% 1KV	C913	1-102-973-00	CERAMIC	100PF 5% 50V
C586	1-107-792-11	CERAMIC	100PF 5% 1KV	C914	1-126-964-11	ELECT	10MF 20% 50V
C587	1-127-979-11	MYLAR	0.36MF 5% 400V	C915	1-162-815-11	CERAMIC	47PF 5% 500V
C588	1-136-191-11	FILM	0.22MF 5% 250V	C916	1-162-815-11	CERAMIC	47PF 5% 500V
C589	1-126-960-11	ELECT	1MF 20% 50V	C917	1-126-961-11	ELECT	2.2MF 20% 50V
C590	1-136-165-00	FILM	0.1MF 5% 50V	C923	1-126-961-11	ELECT	2.2MF 20% 50V
C591	1-136-165-00	FILM	0.1MF 5% 50V	C927	1-162-815-11	CERAMIC	47PF 5% 500V
C592	1-126-964-11	ELECT	10MF 20% 50V	C928	1-162-815-11	CERAMIC	47PF 5% 500V
C593	1-137-378-11	FILM	0.22MF 5% 50V	C929	1-102-973-00	CERAMIC	100PF 5% 500V
C594	1-117-216-11	CERAMIC	0.0022MF 10% 3KV	C930	1-136-165-00	FILM	0.1MF 5% 50V
C595	1-136-209-11	FILM	0.1MF 5% 400V	C950	1-102-074-00	CERAMIC	0.001MF 10% 50V
C596	1-104-331-11	CERAMIC	0.0022MF 10% 1KV	C951	1-102-074-00	CERAMIC	0.001MF 10% 50V
C597	1-136-298-00	FILM	0.0033MF 5% 100V				
C598	1-136-169-00	FILM	0.22MF 5% 50V		<CONNECTOR>		
C599	1-126-969-11	ELECT	220MF 20% 50V		CN501*1-580-798-11	CONNECTOR PIN (DY) 6P	
C601 Δ	1-104-708-51	FILM	0.47MF 20% 250V		CN504*1-564-513-11	PLUG, CONNECTOR 10P	
C602 Δ	1-107-533-51	FILM	1MF 20% 250V		CN506	1-695-915-11	TAB CONTACT
C603 Δ	1-113-905-91	CERAMIC	220PF 10% 250V		CN601 Δ	1-251-444-11	INLET, AC
C604 Δ	1-113-920-91	CERAMIC	0.0022MF 20% 250V		CN603*1-691-960-11	PIN, CONNECTOR (PC BOARD) 3P	
C605	1-113-924-11	CERAMIC	0.0047MF 20% 250V		CN901	1-764-334-11	PLUG, CONNECTOR 11P
C606	1-113-707-11	ELECT(BLOCK)	220MF 20% 450V		CN902*1-564-511-11	PLUG, CONNECTOR 8P	
C607	1-126-947-11	ELECT	47MF 20% 35V				
C608	1-136-209-11	FILM	0.1MF 5% 400V		<DIODE>		
C611	1-102-002-00	CERAMIC	680PF 10% 500V		D402	8-719-052-88	DIODE 1N4002
C612	1-137-393-11	FILM	0.01MF 5% 100V		D501	8-719-911-19	DIODE 1SS119-25
C613	1-102-244-00	CERAMIC	220PF 10% 500V		D502	8-719-923-03	ZENER DIODE MTZJ-T-73-15A
C614	1-136-165-00	FILM	0.1MF 5% 50V				
C615	1-126-933-11	ELECT	100MF 20% 16V				

The components identified by mark Δ are critical for safety. Replace only with part number specified.

Les composants identifiés par une marque Δ sont critiques pour la sécurité. Ne les remplacer que par une pièce portant le numéro spécifié.



REF.NO.	PART NO.	DESCRIPTION	REMARK	REF.NO.	PART NO.	DESCRIPTION	REMARK
D503	8-719-200-89	DIODE 31DF2-FA		FB604	1-469-403-11	INDUCTOR 2UH	
D504	8-719-911-19	DIODE 1SS119-25		FB605	1-469-402-11	INDUCTOR 3UH	
D506	8-719-911-19	DIODE 1SS119-25		FB606	1-469-402-11	INDUCTOR 3UH	
D508	8-719-074-14	DIODE BY459F-1500		FB607	1-469-401-11	INDUCTOR 2.8UH	
D509	8-719-110-14	ZENER DIODE RD9.1ESB3		FB608	1-469-401-11	INDUCTOR 3UH	
D510	8-719-921-42	ZENER DIODE MTZJ-5.1A		FB612 Δ	1-412-911-21	FERRITE 2.3UH	
D511	8-719-074-17	DIODE SR1003		FB613 Δ	1-412-911-21	FERRITE 2.3UH	
D512	8-719-074-17	DIODE SR1003		FB614 Δ	1-412-911-21	FERRITE 2.3UH	
D513	8-719-074-13	DIODE BYV26C		FB615 Δ	1-412-911-21	FERRITE 2.3UH	
D514	8-719-074-17	DIODE SR1003		FB616 Δ	1-412-911-21	FERRITE 2.3UH	
D515	8-719-911-19	DIODE 1SS119-25		FB617 Δ	1-412-911-21	FERRITE 2.3UH	
D516	8-719-911-19	DIODE 1SS119-25		FB618 Δ	1-412-911-21	FERRITE 2.3UH	
D517	8-719-911-19	DIODE 1SS119-25		FB619 Δ	1-412-911-21	FERRITE 2.3UH	
D518	8-719-911-19	DIODE 1SS119-25		FB620	1-469-401-11	INDUCTOR 2.8UH	
D519	8-719-074-17	DIODE SR1003		FB622	1-469-401-11	INDUCTOR 2.8UH	
D521	8-719-074-17	DIODE SR1003		FB901	1-469-403-11	INDUCTOR 2UH	
D522	8-719-074-16	DIODE RGP02-18					
D523	8-719-911-19	DIODE 1SS119-25				<IC>	
D526	8-719-911-19	DIODE 1SS119-25		IC401	8-759-980-58	IC TDA8172	
D592	8-719-911-19	DIODE 1SS119-25		IC501	8-759-582-05	IC TDA4856	
D601 Δ	8-719-074-18	DIODE GBL08-5311		IC502	8-759-502-84	IC LM393M	
D604	8-719-074-17	DIODE SR1003		IC503	8-759-502-80	IC LM358M	
D605	8-719-074-13	DIODE BYV26C		IC504	8-759-502-80	IC LM358M	
D606	8-719-911-19	DIODE 1SS119-25		IC601	8-759-582-09	IC UC3842A	
D607	8-719-110-49	ZENER DIODE RD18ESB2		IC602	8-749-010-64	PHOTO COUPLER PC123F2	
D608	8-719-921-07	ZENER DIODE MTZJ-T-73-24D		IC603	8-759-007-23	IC MC74HC4316N	
D609	8-719-911-19	DIODE 1SS119-25		IC605	8-759-231-53	IC TA7805S	
D610	8-719-911-19	DIODE 1SS119-25		IC606	8-729-048-22	TRANSISTOR MCR100	
D611	8-719-911-19	DIODE 1SS119-25		IC607	8-759-279-76	IC MCT7812CT	
D613	8-719-074-12	DIODE BYM26C		IC901	8-759-582-17	IC ST72T75(OTP)	
D615	8-719-074-12	DIODE BYM26C		IC902	8-759-454-79	IC 24LC16BT/SN	
D616	8-719-074-19	DIODE UF5402G				<COIL>	
D617	8-719-074-19	DIODE UF5402G		L502	1-410-521-11	INDUCTOR 100UH	
D618	8-719-984-46	DIODE SB360		L503	1-459-104-00	COIL, WITH CORE	
D626	8-719-911-19	DIODE 1SS119-25		L505	1-409-896-11	COIL, HORIZONTAL LINEARITY	
D901	8-719-074-21	DIODE LT6463-23-D51		L506	1-459-104-00	COIL, WITH CORE	
D902	8-719-109-66	ZENER DIODE RD3.3ESB2		L507	1-412-550-11	INDUCTOR 1.2MMH	
D903	8-719-911-19	DIODE 1SS119-25		L508	1-410-509-11	INDUCTOR 10UH	
D904	8-719-911-19	DIODE 1SS119-25		L570	1-416-989-11	INDUCTOR 7UH	
D905	8-719-921-42	ZENER DIODE MTZJ-5.1A		L601	1-412-537-31	INDUCTOR 100UH	
D906	8-719-921-42	ZENER DIODE MTZJ-5.1A		L602	1-412-537-31	INDUCTOR 100UH	
D908	8-719-921-42	ZENER DIODE MTZJ-5.1A		L603	1-412-537-31	INDUCTOR 100UH	
D909	8-719-921-42	ZENER DIODE MTZJ-5.1A		L604	1-412-537-31	INDUCTOR 100UH	
D910	8-719-911-19	DIODE 1SS119-25		L606	1-410-645-31	INDUCTOR 100UH	
		<FUSE>		L607	1-410-645-31	INDUCTOR 100UH	
F601 Δ	1-576-231-11	FUSE (H.B.C.) (4A/250V)				<FILTER>	
		<FERRITE BEAD>		LF601 Δ	1-433-798-11	TRANSFORMER, LINE FILTER	
FB501	1-469-402-11	INDUCTOR 3UH				<TRANSISTOR>	
FB502	1-414-793-21	FERRITE 0.45UH		Q401	9-910-999-34	TRANSISTOR 2SC945-P	
FB601	1-469-402-11	INDUCTOR 3UH					
FB602	1-469-401-11	INDUCTOR 2.8UH					
FB603	1-469-402-11	INDUCTOR 3UH					

CPD-110GS/110EST



REF.NO.	PART NO.	DESCRIPTION	REMARK	REF.NO.	PART NO.	DESCRIPTION	REMARK
Q5E2	8-729-238-32	TRANSISTOR 2SC2383-O		R409	1-249-429-11	CARBON 10K	5% 1/4W
Q5E3	8-729-122-12	TRANSISTOR 2SA1221-L		R410	1-247-842-11	CARBON 3K	5% 1/4W
Q501	8-729-027-93	TRANSISTOR 2SC4673D					
Q502	8-729-048-21	TRANSISTOR FS10KM-12		R411	1-249-427-11	CARBON 6.8K	5% 1/4W
				R412	1-249-427-11	CARBON 6.8K	5% 1/4W
Q503	8-729-030-67	TRANSISTOR 2SC5129 (LBSONY1)		R5A3	1-260-127-11	CARBON 220K	5% 1/2W
Q504	8-729-047-46	TRANSISTOR FS7KM-16A		R5A5	1-249-413-11	CARBON 470	5% 1/4W
Q505	9-910-999-34	TRANSISTOR 2SC945-P		R5A6	1-249-429-11	CARBON 10K	5% 1/4W
Q506	8-729-049-35	TRANSISTOR IRF630					
Q507	8-729-049-35	TRANSISTOR IRF630		R5A7	1-249-432-11	CARBON 18K	5% 1/4W
				R5A8	1-247-903-00	CARBON 1M	5% 1/4W
Q508	9-910-999-34	TRANSISTOR 2SC945-P		R5A9	1-249-413-11	CARBON 470	5% 1/4W
Q509	9-910-999-34	TRANSISTOR 2SC945-P		R5C0	1-247-881-00	CARBON 120K	5% 1/4W
Q510	9-910-999-34	TRANSISTOR 2SC945-P		R5C1	1-247-862-11	CARBON 20K	5% 1/4W
Q511	8-729-173-36	TRANSISTOR 2SA733-Q					
Q512	8-729-029-86	TRANSISTOR DTC124ESA		R5C2	1-249-427-11	CARBON 6.8K	5% 1/4W
				R5C3	1-247-872-11	CARBON 51K	5% 1/4W
Q513	8-729-173-36	TRANSISTOR 2SA733-Q		R5C4	1-249-440-11	CARBON 82K	5% 1/4W
Q514	8-729-173-36	TRANSISTOR 2SA733-Q		R5C5	1-249-425-11	CARBON 4.7K	5% 1/4W
Q515	9-910-999-34	TRANSISTOR 2SC945-P		R5C6	1-247-807-31	CARBON 100	5% 1/4W
Q516	8-729-173-36	TRANSISTOR 2SA733-Q					
Q517	8-729-306-92	TRANSISTOR 2SD669AVC		R5C7	1-260-089-91	CARBON 150	5% 1/2W
				R5C9	CARBON 4.3K	5% 1/4W	
Q518	8-729-306-92	TRANSISTOR 2SD669AVC		R5E6	1-249-437-11	CARBON 47K	5% 1/4W
Q519	8-729-119-80	TRANSISTOR 2SC2688-LK		R5E7	1-247-872-11	CARBON 51K	5% 1/4W
Q520	9-910-999-34	TRANSISTOR 2SC945-P		R5E8	1-247-836-11	CARBON 1.6K	5% 1/4W
Q521	8-729-173-36	TRANSISTOR 2SA733-Q		R5E9	1-247-807-31	CARBON 100	5% 1/4W
Q523	8-729-028-34	TRANSISTOR 2SD1640Q,R		R5F1	1-249-429-11	CARBON 10K	5% 1/4W
Q524	8-729-049-35	TRANSISTOR IRF630		R5F2	1-260-079-11	CARBON 22	5% 1/2W
Q526	8-729-029-86	TRANSISTOR DTC124ESA		R5F3	1-249-385-11	CARBON 2.2	5% 1/4W
Q527	8-729-140-50	TRANSISTOR 2SC3209LK		R5F4	1-247-822-11	CARBON 430	5% 1/4W
Q528	9-910-999-34	TRANSISTOR 2SC945-P		R5F5	1-249-413-11	CARBON 470	5% 1/4W
Q529	9-910-999-34	TRANSISTOR 2SC945-P		R5F6	1-260-070-11	CARBON 3.3	5% 1/2W
Q530	8-729-119-80	TRANSISTOR 2SC2688-LK		R500	1-249-393-11	CARBON 10	5% 1/4W
Q531	8-729-321-62	TRANSISTOR 2SC1921		R501	1-249-434-11	CARBON 27K	5% 1/4W
Q532	8-729-823-81	TRANSISTOR 2SC4632LS-CB7		R502	1-240-905-11	METAL 22.1K	1% 1/4W
Q533	8-729-173-36	TRANSISTOR 2SA733-Q		R503	1-249-425-11	CARBON 4.7K	5% 1/4W
Q534	8-729-029-86	TRANSISTOR DTC124ESA		R504	1-240-891-11	METAL 1.18K	1% 1/4W
Q601	8-729-173-36	TRANSISTOR 2SA733-Q		R505	1-240-894-11	METAL 2.8K	1% 1/4W
Q602	8-729-048-21	TRANSISTOR FS10KM-12		R506	1-249-429-11	CARBON 10K	5% 1/4W
Q607	8-729-200-35	TRANSISTOR 2SA966-O		R507	1-260-068-11	CARBON 2.2	5% 1/2W
Q608	8-729-029-86	TRANSISTOR DTC124ESA		R508	1-240-904-11	METAL 18.2K	1% 1/4W
Q609	8-729-200-35	TRANSISTOR 2SA966-O		R509	1-240-883-11	CARBON 4.3K	
Q610	8-729-029-86	TRANSISTOR DTC124ESA		R510	1-247-807-31	CARBON 100	5% 1/4W
Q615	9-910-999-34	TRANSISTOR 2SC945-P		R511	1-247-807-31	CARBON 100	5% 1/4W
Q901	9-910-999-34	TRANSISTOR 2SC945-P		R513	1-247-807-31	CARBON 100	5% 1/4W
Q902	9-910-999-34	TRANSISTOR 2SC945-P		R515	1-249-417-11	CARBON 1K	5% 1/4W
Q907	8-729-139-04	TRANSISTOR 2N3904		R516	1-247-878-00	CARBON 91K	5% 1/4W
Q908	8-729-139-04	TRANSISTOR 2N3904		R517	1-249-442-11	CARBON 510	5% 1/4W
				R518	1-247-896-11	CARBON 510K	5% 1/4W
				R519	1-249-415-11	CARBON 680	5% 1/4W
				R520	1-240-900-11	METAL 7.5K	1% 1/4W
				R521	1-240-902-11	METAL 10K	1% 1/4W
				R522	1-249-425-11	CARBON 4.7K	5% 1/4W
				R524	1-249-428-11	CARBON 8.2K	5% 1/4W
				R525	1-249-393-11	CARBON 10	5% 1/4W
				R526	1-249-425-11	CARBON 4.7K	5% 1/4W
				R527	1-249-429-11	CARBON 10K	5% 1/4W
R401	1-240-893-11	METAL 1.78K	1% 1/4W				
R402	1-240-893-11	METAL 1.78K	1% 1/4W				
R403	1-260-070-11	CARBON 3.3	5% 1/2W				
R404	1-216-348-00	METAL OXIDE 0.82	5% 1W F				
R405	1-249-417-11	CARBON 1K	5% 1/4W				
R406	1-249-383-11	CARBON 1.5	5% 1/4W F				
R407	1-260-093-11	CARBON 330	5% 1/2W				
R408	1-249-425-11	CARBON 4.7K	5% 1/4W	R528	1-260-091-11	CARBON 220	5% 1/2W
				R529	1-247-878-00	CARBON 91K	5% 1/4W

The components identified by mark Δ are critical for safety.
Replace only with part number specified.

Les composants identifiés par une marque Δ sont critiques pour la sécurité.
Ne les remplacer que par une pièce portant le numéro spécifié.



REF.NO.	PART NO.	DESCRIPTION	REMARK	REF.NO.	PART NO.	DESCRIPTION	REMARK
R530	1-240-887-11	METAL OXIDE	1.5 5% 3W	R594	1-247-903-00	CARBON	1M 5% 1/4W
R531	1-249-429-11	CARBON	10K 5% 1/4W	R595	1-249-441-11	CARBON	100K 5% 1/4W
R532	1-260-083-11	CARBON	47 5% 1/2W	R596 Δ	1-240-909-11	METAL	127K 1% 1/4W
R533	1-215-870-11	METAL OXIDE	1.5K 5% 1W F	R598	1-240-906-11	METAL	24.3K 1% 1/4W
R534	1-215-880-00	METAL OXIDE	10 5% 2W F	R599	1-240-897-11	METAL	4.99K 1% 1/4W
R535	1-249-417-11	CARBON	1K 5% 1/4W	R601 Δ	1-260-132-11	CARBON	560K 5% 1/2W
R536	1-249-427-11	CARBON	6.8K 5% 1/4W	R602	1-216-341-11	METAL OXIDE	0.22 5% 1W F
R537	1-249-417-11	CARBON	1K 5% 1/4W	R605	1-208-287-91	METAL OXIDE	30K 5% 1W F
R538	1-249-425-11	CARBON	4.7K 5% 1/4W	R609	1-249-422-11	CARBON	2.7K 5% 1/4W
R539	1-249-429-11	CARBON	10K 5% 1/4W	R610	1-249-393-11	CARBON	10 5% 1/4W
R540	1-260-129-11	CARBON	330K 5% 1/2W	R611	1-249-396-11	CARBON	18 5% 1/4W
R543	1-216-429-00	METAL OXIDE	270 5% 1W F	R612	1-240-899-11	METAL	5.49K 1% 1/4W
R544	1-260-123-11	CARBON	100K 5% 1/2W	R614	1-216-361-00	METAL OXIDE	0.22 5% 2W F
R545	1-260-123-11	CARBON	100K 5% 1/2W	R615	1-249-417-11	CARBON	1K 5% 1/4W
R546	1-260-123-11	CARBON	100K 5% 1/2W	R616	1-247-850-91	CARBON	6.2K 5% 1/4W
R547	1-249-425-11	CARBON	4.7K 5% 1/4W	R618	1-249-429-11	CARBON	10K 5% 1/4W
R548	1-249-425-11	CARBON	4.7K 5% 1/4W	R619	1-249-429-11	CARBON	10K 5% 1/4W
R549	1-249-429-11	CARBON	10K 5% 1/4W	R620	1-249-417-11	CARBON	1K 5% 1/4W
R550	1-249-429-11	CARBON	10K 5% 1/4W	R621	1-247-815-91	CARBON	220 5% 1/4W
R551	1-249-437-11	CARBON	47K 5% 1/4W	R622	1-247-815-91	CARBON	220 5% 1/4W
R552	1-240-889-11	METAL	100 1% 1/4W	R623	1-247-807-31	CARBON	100 5% 1/4W
R553	1-249-429-11	CARBON	10K 5% 1/4W	R624	1-247-854-11	CARBON	9.1K 5% 1/4W
R554	1-249-425-11	CARBON	4.7K 5% 1/4W	R625	1-249-429-11	CARBON	10K 5% 1/4W
R555	1-249-429-11	CARBON	10K 5% 1/4W	R626	1-249-431-11	CARBON	15K 5% 1/4W
R556	1-249-441-11	CARBON	100K 5% 1/4W	R627	1-240-896-11	METAL	3.74K 1% 1/4W
R557	1-215-880-00	METAL OXIDE	10 5% 2W F	R628	1-247-802-11	CARBON	62 5% 1/4W
R558	1-249-441-11	CARBON	100K 5% 1/4W	R629	1-249-417-11	CARBON	1K 5% 1/4W
R559	1-249-425-11	CARBON	4.7K 5% 1/4W	R630	1-249-425-11	CARBON	4.7K 5% 1/4W
R560	1-249-429-11	CARBON	10K 5% 1/4W	R640	1-249-441-11	CARBON	100K 5% 1/4W
R561	1-249-393-11	CARBON	10 5% 1/4W	R641	1-249-413-11	CARBON	470 5% 1/4W
R562	1-247-791-91	CARBON	22 5% 1/4W	R642	1-247-815-91	CARBON	220 5% 1/4W
R563	1-249-441-11	CARBON	100K 5% 1/4W	R643	1-240-908-11	METAL	88.7K 1% 1/4W
R565	1-249-417-11	CARBON	1K 5% 1/4W	R644	1-240-895-11	METAL	3.01K 1% 1/4W
R566	1-247-903-00	CARBON	1M 5% 1/4W	R650	1-260-089-91	CARBON	150 5% 1/2W
R567	1-249-429-11	CARBON	10K 5% 1/4W	R651	1-249-429-11	CARBON	10K 5% 1/4W
R568	1-249-421-11	CARBON	2.2K 5% 1/4W	R652	1-249-417-11	CARBON	1K 5% 1/4W
R569	METAL		2.2M 1/2W	R653	1-215-888-00	METAL OXIDE	220 5% 2W F
R570	1-215-910-81	METAL OXIDE	68 5% 3W	R656	1-249-429-11	CARBON	10K 5% 1/4W
R571	1-249-429-11	CARBON	10K 5% 1/4W	R658	1-249-429-11	CARBON	10K 5% 1/4W
R572	1-249-393-11	CARBON	10 5% 1/4W	R664	1-219-154-11	FUSIBLE	0.12 10% 1/4W
R573	1-247-894-11	CARBON	430K 5% 1/4W	R665	1-249-429-11	CARBON	10K 5% 1/4W
R574	1-247-894-11	CARBON	430K 5% 1/4W	R666	1-249-415-11	CARBON	680 5% 1/4W
R575	1-240-884-11	CARBON	3.3K 5% 1/4W	R667	1-260-121-11	CARBON	68K 5% 1/2W
R576	1-215-888-00	METAL OXIDE	220 5% 2W F	R901	1-249-417-11	CARBON	1K 5% 1/4W
R577	1-247-802-11	CARBON	62 5% 1/4W	R906	1-247-807-31	CARBON	100 5% 1/4W
R578	1-215-490-00	CARBON	750K 5% 1/4W	R907	1-249-417-11	CARBON	1K 5% 1/4W
R579	1-260-079-11	CARBON	22 5% 1/2W	R908	1-249-417-11	CARBON	1K 5% 1/4W
R580	1-247-807-31	CARBON	100 5% 1/4W	R910	1-249-429-11	CARBON	10K 5% 1/4W
R581	1-215-910-81	METAL OXIDE	68 5% 3W	R911	1-249-429-11	CARBON	10K 5% 1/4W
R582	1-249-418-11	CARBON	1.2K 5% 1/4W	R914	1-240-902-11	METAL	10K 1% 1/4W
R583	1-240-887-11	METAL OXIDE	1.5 5% 3W	R915	1-240-898-11	METAL	5.11K 1% 1/4W
R587	1-249-389-11	CARBON	4.7 5% 1/4W	R917	1-240-890-11	METAL	1K 1% 1/4W
R588	1-249-426-11	CARBON	5.6K 5% 1/4W	R918	1-249-429-11	CARBON	10K 5% 1/4W
R589	1-249-426-11	CARBON	5.6K 5% 1/4W	R919	1-247-807-31	CARBON	100 5% 1/4W
R590	1-249-426-11	CARBON	5.6K 5% 1/4W	R923	1-247-791-91	CARBON	22 5% 1/4W
R592	1-249-438-11	CARBON	56K 5% 1/4W	R924	1-247-791-91	CARBON	22 5% 1/4W
R593	1-249-417-11	CARBON	1K 5% 1/4W				

CPD-110GS/110EST



The components identified by **D** in this manual have been carefully factory-selected for each set in order to satisfy regulations regarding X-ray radiation. Should replacement be required, replace only with the value originally used.

Les composants identifiés par une marque **D** sont critiques pour la sécurité. Ne les remplacer que par une pièce portant le numéro spécifié.

The components identified by mark **△** are critical for safety. Replace only with part number specified.

REF.NO.	PART NO.	DESCRIPTION	REMARK	REF.NO.	PART NO.	DESCRIPTION	REMARK
R925	1-247-791-91	CARBON	22	5%	1/4W	<NETWORK RESISTOR>	
R926	1-247-791-91	CARBON	22	5%	1/4W		
R927	1-247-903-00	CARBON	1M	5%	1/4W	RN901 1-234-276-11 RES, NETWORKS	
R928	1-249-429-11	CARBON	10K	5%	1/4W	RN902 1-234-277-11 RES, NETWORKS	
R929	1-249-429-11	CARBON	10K	5%	1/4W		
R930	1-249-429-11	CARBON	10K	5%	1/4W	<VARIABLE RESISTOR>	
R931	1-249-413-11	CARBON	470	5%	1/4W		
R932	1-249-413-11	CARBON	470	5%	1/4W	D RV501 \triangle 1-241-767-21 RES, ADJ, CERMET 100K (HV ADJ)	
R933	1-249-425-11	CARBON	4.7K	5%	1/4W		
R934	1-249-425-11	CARBON	4.7K	5%	1/4W	<RELAY>	
R935	1-249-408-11	CARBON	180	5%	1/4W		
R936	1-249-408-11	CARBON	180	5%	1/4W	RY601 \triangle 1-755-031-11 RELAY	
R949	1-249-429-11	CARBON	10K	5%	1/4W		
R950	1-249-429-11	CARBON	10K	5%	1/4W	<SWITCH>	
R951	1-249-429-11	CARBON	10K	5%	1/4W	S601 \triangle 1-771-668-11 SWITCH, AC POWER PUSH	
R954	1-247-791-91	CARBON	22	5%	1/4W	S901 1-771-670-11 SWITCH, TACTILE (MENU/ENTER)	
R955	1-249-425-11	CARBON	4.7K	5%	1/4W	S902 1-771-670-11 SWITCH, TACTILE (RIGHT +)	
R956	1-249-417-11	CARBON	1K	5%	1/4W	S903 1-771-670-11 SWITCH, TACTILE (LEFT -)	
R959	1-247-791-91	CARBON	22	5%	1/4W		
R960	1-247-791-91	CARBON	22	5%	1/4W		
R961	1-240-890-11	METAL	1K	1%	1/4W	<SPARK GAP>	
R962	1-247-791-91	CARBON	22	5%	1/4W		
R963	1-249-429-11	CARBON	10K	5%	1/4W	SG501 1-519-422-11 GAP, SPARK	
R964	1-247-791-91	CARBON	22	5%	1/4W		
R965	1-249-429-11	CARBON	10K	5%	1/4W	<TRANSFORMER>	
R967	1-249-428-11	CARBON	8.2K	5%	1/4W	T501 \triangle 1-453-301-11 TRANSFORMER, FLYBACK	
R968	1-249-425-11	CARBON	4.7K	5%	1/4W	T502 1-431-248-11 TRANSFORMER, FERRITE (HDT)	
R969	1-249-417-11	CARBON	1K	5%	1/4W	T503 1-433-799-11 TRANSFORMER, FERRITE (HST)	
R970	1-249-425-11	CARBON	4.7K	5%	1/4W	T504 1-429-109-11 TRANSFORMER, FERRITE (DFT)	
R971	1-240-892-11	METAL	1.4K	1%	1/4W	T601	
R972	1-249-425-11	CARBON	4.7K	5%	1/4W		
R973	1-249-417-11	CARBON	1K	5%	1/4W	T603 \triangle 1-433-796-11 TRANSFORMER	
R974	1-240-888-11	METAL	33.2	1%	1/4W		
R975	1-240-907-11	METAL	30.1K	1%	1/4W	<THERMISTOR>	
R976	1-240-901-11	METAL	9.31K	1%	1/4W	TH601 \triangle 1-803-533-11 THERMISTOR	
R977	1-240-903-11	METAL	13.3K	1%	1/4W	* 1-506-371-00 PIN, CONNECTOR 2P; TH601	
R978	1-249-441-11	CARBON	100K	5%	1/4W	TH602 \triangle 1-809-827-11 THERMISTOR, POSITIVE	
R979	1-249-441-11	CARBON	100K	5%	1/4W		
						<CRYSTAL>	
						X901 1-781-365-11 VIBRATOR, CRYSTAL	