

SANYO

INSTRUCTION MANUAL

Dual Camera

Xacti **HD**
HIGH DEFINITION

VPC-CA100EX
VPC-CA100GX
VPC-CA100PX
VPC-CA100TA
VPC-CA102



SD
XC
HDMI
HIGH-DEFINITION MULTIMEDIA INTERFACE

Important note

This manual explains how to safely operate the VPC-CA100EX, VPC-CA100GX, VPC-CA100PX, VPC-CA100TA and VPC-CA102. Any information regarding only one of these products will be labeled as such.

Please read these instructions carefully before using the camera. Make sure to read and understand the separate booklet "SAFETY MANUAL". Keep this manual in a safe place for later reference.

Warning

TO PREVENT THE RISK OF FIRE OR ELECTRIC SHOCK, DO NOT EXPOSE THIS APPLIANCE TO RAIN OR MOISTURE

■ FOR AMERICAN USERS

The following advisory is included in accordance with the laws of the State of California (USA):

WARNING:

This product contains chemicals, including lead, known to the State of California to cause cancer, birth defects or other reproductive harm. **Wash hands after handling.**

- This equipment has been tested and found to comply with the limits for a Class B digital device, pursuant to Part 15 of the FCC Rules. These limits are designed to provide reasonable protection against harmful interference in a residential installation. This equipment generates, uses and can radiate radio frequency energy and, if not installed and used in accordance with the instructions, may cause harmful interference to radio communications. However, there is no guarantee that interference will not occur in a particular installation. If this equipment does cause harmful interference to radio or television reception, which can be determined by turning the equipment off and on, the user is encouraged to try to correct the interference by one or more of the following measures:
 - Reorient or relocate the receiving antenna.
 - Increase the separation between the equipment and receiver.
 - Connect the equipment into an outlet on a circuit different from that to which the receiver is connected.
 - Consult the dealer or an experienced radio/TV technician for help.
- Changes or modifications not expressly approved by the party responsible for compliance could void the user's authority to operate the equipment.

Declaration of Conformity

Model number: VPC-CA102

Trade Name: SANYO

Responsible party: SANYO North America Corporation

Address: 21605 Plummer Street, Chatsworth, California 91311

Telephone No.: (818) 998-7322

This device complies with Part 15 of the FCC Rules. Operation is subject to the following two conditions:

- (1) this device may not cause harmful interference, and
- (2) this device must accept any interference received, including interference that may cause undesired operation.

■ FOR CANADIAN USERS

- This Class B digital apparatus complies with Canadian ICES-003.

■ FOR EU USERS

The symbol mark and recycling systems described below apply to EU countries and do not apply to countries in other areas of the world.

Your SANYO product is designed and manufactured with high quality materials and components which can be recycled and/or reused.

The symbol mark means that electrical and electronic equipment, batteries and accumulators, at their end-of-life, should be disposed of separately from your household waste.

Note:

If a chemical symbol is printed beneath the symbol mark, this chemical symbol means that the battery or accumulator contains a heavy metal at a certain concentration. This will be indicated as follows: Hg: mercury, Cd: cadmium, Pb: lead

In the European Union there are separate collection systems for used electrical and electronic equipment, batteries and accumulators.

Please, dispose of them correctly at your local community waste collection/recycling centre.

Please, help us to conserve the environment we live in!



SANYO Sales & Marketing Europe GmbH

Stahlgruberring 4, D-81829 München, Germany

SANYO Electric Co., Ltd.

1-1, Sanyo-cho, Daito City, Osaka 574-8534, Japan

■ FOR RUSSIAN USERS



AP46

This product is certified by an official certification company which is authorized by the Russian Federation.

HOW TO READ THIS MANUAL

For first-time users

Please read the sections on “SETUP” and “SIMPLE” in this manual to familiarize yourself with your camera’s operation.



To use the various camera features

Please read the sections on “NORMAL” and “OPTION SETTINGS” in this manual. To view on a TV, please read the section on “CONNECTING TO A TV” in this manual. To connect to a computer, please see the “Xacti Software CD INSTRUCTION MANUAL”.



To use additional features

Visit the Sanyo website to learn how to adjust the camera settings for various shooting scenes. There you’ll also find information about the software for playing back data recorded with your camera and for burning (recording) DVDs (page 4 in the Xacti Software CD INSTRUCTION MANUAL).

You may find the answers to questions or problems concerning camera operation in the sections “COMMONLY ASKED QUESTIONS” (page 145) and “TROUBLESHOOTING” (page 153).

Symbols used in this manual

- | | |
|------------------|---|
| HINT | Points giving some extended instructions or special points to pay attention to. |
| CAUTION | Points that require special attention. |
| (page xx) | Refer to the page indicated for detailed information. |

SHOOT, PLAY BACK AND SAVE

Preparing the camera

1 Insert the battery pack.

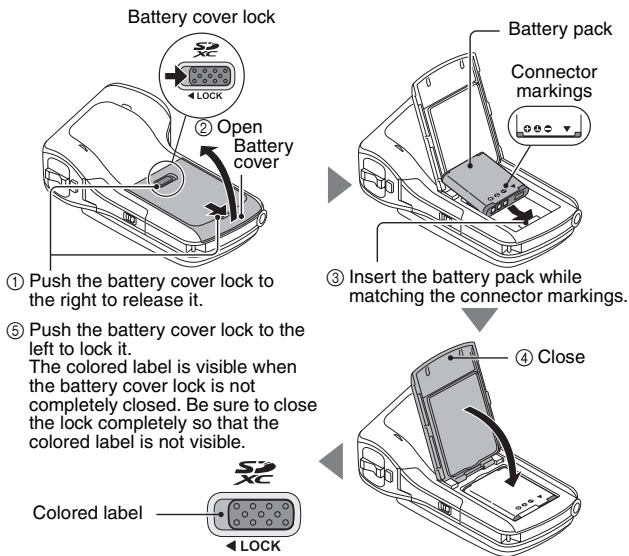

About saving your recorded data

- If you wish to use an SD Memory Card, refer to page 22 to install the card in the camera.
- An SD Memory Card is not included with your camera. Please purchase a commercially sold card.
- This camera has an internal memory, so you can shoot and record without an SD Memory Card installed.

Shooting



- 1** Press the **ON/OFF** button for at least 1 second to turn the camera on.

- If the screen to set the date and time appears, press the **MENU** button 2 times to cancel it.

For how to set the date and time, see page 33.

- 2** Record.

To record a video clip:

- Press the [] button to begin recording a video clip.
- Press the [] button again to end the recording.

To take a photo:

- Press the [] button.
- A still image is captured.

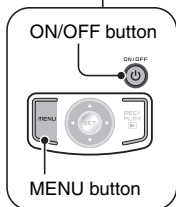
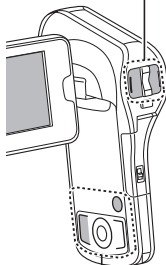
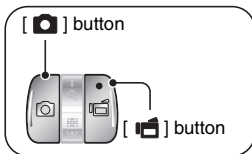

Before capturing those important shots, be sure to first take a test shot to confirm that your camera is set up and ready to go

- Sanyo declines any claim for compensation for recorded contents etc. in case of photographing or recording failure due to a chance camera or card flaw.

Playback

1 Press the REC/PLAY button.

- The display changes to the Playback Screen.

2 Select the image to play back.

- Use the arrow keys to move the orange frame to the image you wish to play back.
- The image information for the framed image is shown in the bottom part of the monitor.

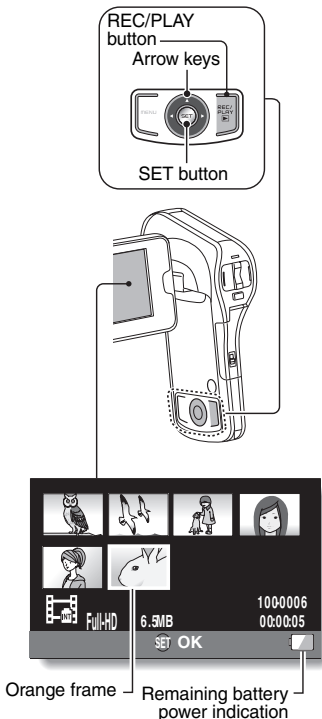

-
- 3** Press the SET button.
<To return to the recording mode>
- Press the REC/PLAY button.

When you are finished using the camera...

Press the ON/OFF button for at least 1 second to turn the camera off.

To continue to the next operation...

Please confirm that your computer is connected to the Internet.

Burn your recorded video clips onto a DVD

Using the supplied CD-ROM (Xacti Software CD), you can store your captured images on a DVD.

Install application program

- 1 Set the supplied CD-ROM in your computer's DVD drive.**
 - The installation window opens.
- 2 Click on [TotalMedia Extreme for SANYO].**
 - After clicking on the application program, follow the instructions shown on the monitor to install the program.
 - When the window appears requesting to restart your computer, click the [Finish] button to reboot.
- 3 Remove the CD-ROM from the computer's DVD drive.**
 - <About the Kodak online service>**
 - When the installation window closes, a dialog box to connect to the website introducing Kodak's online service appears. Check the [No thanks !] option button, and then click on the [OK] button.

Copy data from your camera to the computer

Connect your camera to a computer, and copy the desired data to the computer.

1 Turn on the computer, and use the supplied dedicated USB interface cable to connect your camera to the computer.

- Connect the cable between the camera's USB AV terminal and the computer's USB connector.

2 Turn on the camera (page 30).

- The USB Connection Screen appears on the camera's monitor.

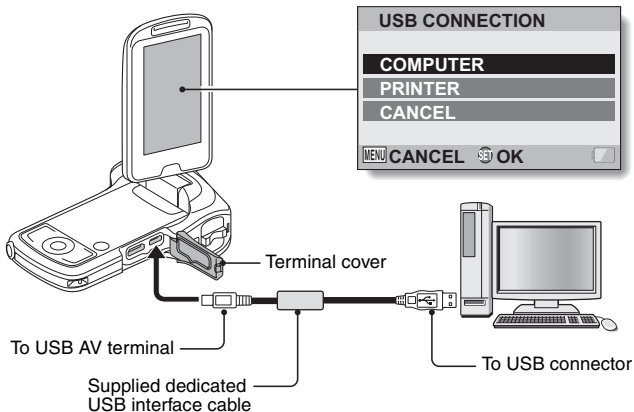

How to open the terminal cover

- ① Push the battery cover lock.

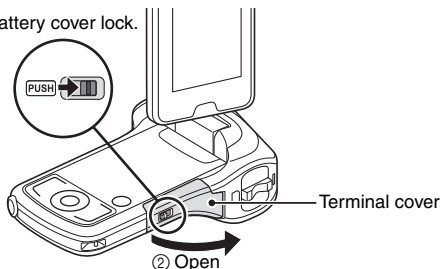

3 Select “COMPUTER”, and press the SET button.

- The screen to select the computer connection mode appears.

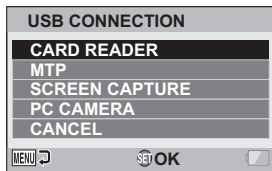

4 Select “CARD READER”, and press the SET button.

5 Double-click the [TotalMedia Extreme for SANYO] icon on the desktop.

- TotalMedia Extreme for SANYO is launched, and the initial screen appears.



6 Click the [Management] icon.

- The ArcSoft MediaImpression for SANYO screen appears.

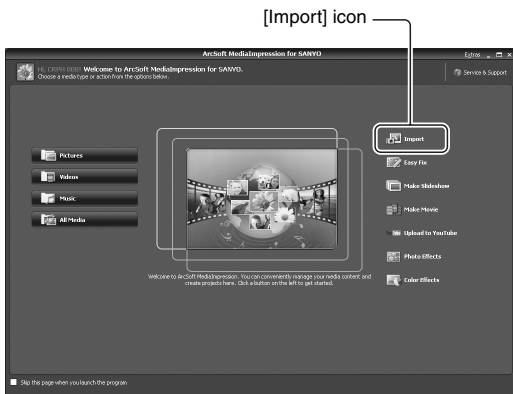

7 Click the [Import] icon.

- The screen to select files to copy (import) to your computer appears.

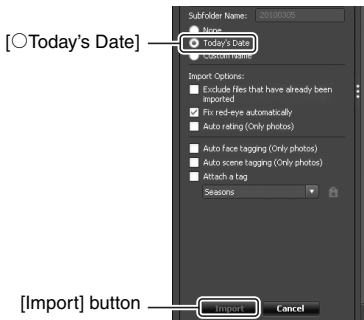

8 Click the [Today's Date] of the [Subfolder Name], and click the [Import] button.

- Copying begins.
- When copying is completed, a window showing the result appears.

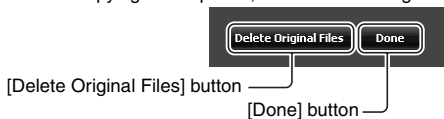

9 Click the [Done] button.

- If desired, you can click the [Delete Original Files] button to delete the file in the camera from which the copy was made.

10 Click the [x] close button in the upper right corner of the ArcSoft MediaImpression for SANYO window.

- You are returned to the top page of TotalMedia Extreme for SANYO.

11 Click the [x] button in the upper right corner of the TotalMedia Extreme for SANYO window.

- TotalMedia Extreme for SANYO is exited.

Burn video clips onto a DVD

Here's how to write your recorded data onto a DVD in the MPEG2 format. For information on other operations, please see the Help file for TotalMedia Extreme.

1 Insert a blank DVD in your computer's DVD drive.

2 Double-click the desktop [TotalMedia Extreme for SANYO] icon.

- TotalMedia Extreme for SANYO is launched, and the startup page appears.

[Create video] icon

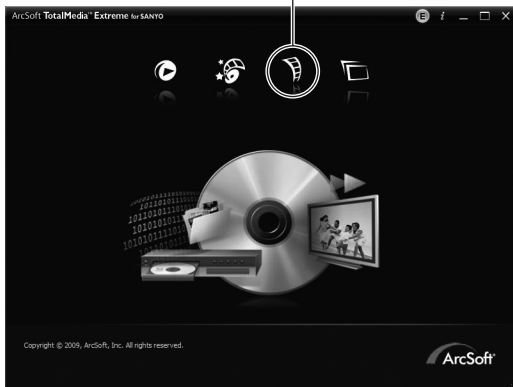

- 3** Click the [Create video] icon.
- The TotalMedia Studio screen appears.



4 Click [New DVD project].

- The screen to create a video clip to burn to DVD appears.

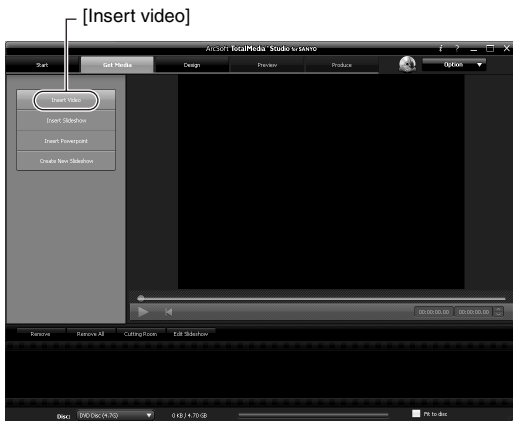

5 Click [Insert video].

- The screen to select the video clip file to burn to DVD appears.
- Click on the file you wish to burn to DVD.
- To select multiple files, keep the [Ctrl] key pressed while selecting files.

6 Click the [Open] button.

- The files you selected in step 5 and the total size of the files to burn to DVD are shown in the lower part of the window.



7 Click the [Design] tab.

- The screen to design the title menu that is shown when the DVD is played appears.
- Select one of the designs.



8 Click the [Produce] tab.

- The screen to burn files to the DVD appears.



[Burn] button

9 Click the [Burn] button.

- A window appears asking if you wish to save the project.
- Saving the project will save your settings from steps 5 through 7.
- It is recommended that you save the project if you intend to again edit the same video clips that you burned to DVD.

10 Click the [Yes] button.

- The screen to save the project appears.
- Assign a suitable file name for the project.

11 Click the [Save] button.

- The current project is saved, and the DVD burn process begins.
- When the burn process is completed, a window appears to inform you that the process is done. Remove the DVD from the computer's DVD drive.

12 Click the [OK] button.

- You are returned to the screen to burn files to DVD.

13 Click the [X] close button in the upper right corner.

- You are returned to the top page.

14 Click the [X] close button in the upper right corner.

- TotalMedia Extreme for SANYO is exited.

HINT

About software upgrades

- For information concerning TotalMedia Extreme upgrades, please go to the following website:
<http://www.arcsoft.com/en-us/index.asp>
 - If TotalMedia Extreme is launched while you are connected to the Internet, automatic program update notifications may appear.

To use Blu-ray Disc or AVCHD

- The version of TotalMedia Extreme that accompanies your camera cannot be used to burn these formats. To purchase a different version, please refer to the following website.
<http://sanyo.com/xacti/english/>

CAUTION

Does the window requesting confirmation to enable the MPEG-2 Codec appear?

When using TotalMedia Extreme for the first time, a window requesting you to confirm activation of the MPEG-2 Codec appears during the procedure. The MPEG-2 Codec must be activated in order to burn files to a DVD. Complete the following procedure to activate the MPEG-2 Codec.

- Note that your computer must be connected to the Internet in order to complete this procedure. Please confirm that your computer is connected to the Internet.
- ① **When the window requesting confirmation to activate the MPEG-2 Codec appears, click the [Yes] button.**
 - The ArcSoft website appears.
 - ② **Click on [Special downloads].**
 - The window appears for you to enter your email address, name, license ID, etc.
 - Enter the correct information.
 - The license ID is located on the back card of the supplied CD-ROM.
 - ③ **Click the [Submit] button.**
 - Soon thereafter, the URL for the download to activate the MPEG-2 Codec will be sent to the email address you entered in step ②.
 - ④ **Click the download URL link.**
 - The program will be downloaded to your computer.
 - ⑤ **Double-click the icon for the downloaded program.**
 - Follow the instructions to activate the MPEG-2 Codec.
 - DVD burning via the TotalMedia Extreme program is now enabled.
 - When the procedure above has been completed, continue to the procedure to burn to DVD.

United States/Canada

Tel: +1-510-979-5599

Web: <http://www.arcsoft.com/support/>

E-mail Support: http://www.arcsoft.com/public/content_page.asp?pageID=83

Hours: M-F from 9:00am - 5:00pm

(Pacific Standard Time, excluding holidays observed by ArcSoft)

Language: English

Europe

Tel: +353 (0) 61-702087

Web: <http://www.arcsoft.com/en/support>

Email Support: eurosupport@arcsoft.com

Hours: M-Th from 8:30am - 5:30pm GMT

(excluding holidays observed by ArcSoft's Affiliate)

F from 8:30am - 5:00pm GMT

(excluding holidays observed by ArcSoft's Affiliate)

(Adjusted for daylight savings time when applicable)

Language: English, French, Italian, German, Spanish and Dutch

China

Tel: +86 (0) 571-88210575

Web: <http://www.arcsoft.com.cn/support>

E-Mail Support: support@arcsoft.com.cn

Hours: M-F 8:30am-5:30pm

(Beijing local time) (excluding holidays observed by ArcSoft)

Language: Chinese

Important!

Concerning your camera's waterproof feature

This camera complies with JIS IPX8 (formerly JIS protection grade 8) waterproof standard and can be used in water. Note, however, that failing to heed the following precautions may result in damage or injury that is not covered by the warranty. Please take the time to carefully read and heed the following cautions.

NOTE

■ Before using the camera

- When closing the battery cover and terminal cover, make sure that no foreign object such as sand, hair, dust, etc. is caught in the rubber seal.
- Make sure that the battery cover and terminal cover are completely and securely closed to prevent water from getting inside the camera and damaging it.
- Please note that the camera accessories are not waterproof.



■ Cautions concerning use in water

- The waterproof properties of the camera apply to fresh water and saltwater only; they do not apply to cleaning substances, chemicals or water from spas, etc. In case of a splash, immediately wipe off any moisture.
- Do not immerse in water at a depth greater than 3.0 m (9.84 ft.).
- Do not subject the camera to high-pressure water.
- Do not immerse in water for longer than 60 minutes. After 60 minutes of use in water, allow it to dry for at least 10 minutes.
- Do not immerse in water that is warmer than 40 °C (104°F).
- Do not open and close the battery cover or terminal cover when the camera is wet or while it is immersed in water.
- Do not open and close the battery cover or terminal cover with wet hands.
- Do not open the battery cover or terminal cover on the beach or at the poolside.
- Do not jolt the camera while it is immersed in water. Doing so may cause the battery cover or terminal cover to open.

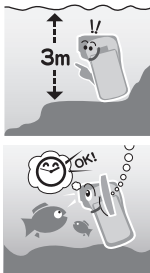

NOTE

■ Storing and maintaining your camera

- Do not leave the camera unwashed after it has been immersed in salt water or if salt water is adhering to it. Doing so may cause corrosion and discoloration of the plating, as well as deterioration of the camera's waterproof capability.
- After the camera has been used in water, use fresh water to wash it. Never use soap or detergent to clean the camera, as doing so will cause deterioration of the camera's waterproof capability.
- After washing the camera, take care to completely drain it, and use a dry cloth to wipe off any drops of water adhering to it (page 69).
- Do not leave the camera in an environment colder than 0 °C (32°F) or warmer than 40 °C (104°F), as doing so may cause deterioration of the camera's waterproof capability.
- Waterproof seals are used in this camera. It is recommended that the waterproof seals be replaced every year with new ones. For replacing the seals, please consult your dealer.
 - * Please note that there is a fee for replacing the waterproof seal.



■ Beware of condensation

- Avoid opening and closing the battery cover and terminal cover in a high humidity environment, as doing so may cause condensation inside the camera.
- If condensation has formed inside the camera, as indicated for example by a cloudy lens, open the covers in a dry environment and leave the camera to dry.

■ Other cautions

- Do not subject the camera to severe jolts, as doing so may deform the battery cover, terminal cover or the camera body, thus compromising its waterproof capability. If the camera has been subjected to a strong jolt, please consult with your dealer.

HINT

What is “JIS IPX8” (formerly “JIS protection grade 8”)?

- “JIS IPX8” specifies that a device is protected against the effects of continuous immersion in water.

BEFORE RECORDING IN WATER

Make sure that the battery cover (page 25) and the terminal cover (page 21) are closed.

If a cover is open, water will get inside the camera and damage it.

When closing the battery cover and terminal cover, make sure that no foreign object such as sand, hair, dust, etc. is caught in the rubber seal.

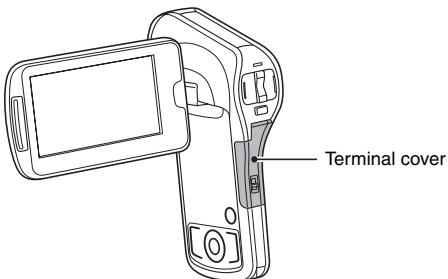
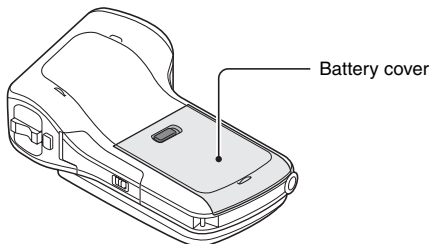

CONTENTS

HOW TO READ THIS MANUAL	iii
QUICK SEARCH BY OPERATION	6
CHECKING THE INCLUDED ACCESSORIES	11
How to use the accessories	13
About the power plug	13
ABOUT THE CARD	14
Media cards that can be used with this camera	14
What “card” means in this manual	14
GETTING THE MOST OUT OF YOUR CAMERA	15
Waterproof capability	15
High-quality images with “Full High Definition*”	16
Includes SIMPLE mode for quick-and-easy operation	17
Image stabilizer for sharp pictures	17
Capture clear images of the targeted subject	18
Eye-Fi smart	18
SYSTEM MAP	19

■ SETUP

PARTS NAMES	20
INSTALLING THE CARD	22
CHARGING THE BATTERY PACK	24
About recharging	29
About the temperature alert icon 	29
TURNING THE CAMERA ON AND OFF	30
Turning on the camera	30
Turning off the camera	30
Turning on the camera when the power save (sleep) mode is active	31
DATE AND TIME SETTING	33
SWITCHING BETWEEN THE RECORDING MODE AND PLAYBACK MODE	35
SWITCHING THE OPERATING MODE	36
Switching between the SIMPLE and NORMAL modes	36
Accessing/exiting the SIMPLE/NORMAL Mode Menu Screen	37
Overview of the SIMPLE Mode Setting Screen	41
Overview of the NORMAL Mode Setting Screen	45

■ SIMPLE

SHOOTING

BEFORE TAKING PICTURES	53
For best results	53
Using the autofocus	54
Select the recording size	56
Select the focus setting	57
Hints for taking pictures	58
VIDEO CLIP RECORDING	59
SHOOTING SINGLE SHOTS	60
Using the flash	63
SHOOT A STILL IMAGE WHILE RECORDING A VIDEO CLIP	65
MACRO-PHOTOGRAPHY (ZOOM)	67
AFTER USING THE CAMERA IN WATER	69

PLAYBACK

PLAYING BACK VIDEO CLIPS AND STILL IMAGES	70
How to save one frame from a video clip as a still image	73
SLIDESHOW PLAYBACK	74
PLAYBACK VOLUME	75
DELETING FILES	76
Delete single/delete all/delete folder	76
Delete selected	77
PLAYBACK MODES	79
21-image display playback	79
Selecting the playback folder	80
Magnifying (zooming in) the image	81

■ NORMAL

SHOOTING

RECORDING MENU 1	82
Video setting	82
Still image setting	85
Scene select setting	86
Filter setting	86
Self-timer setting	87
RECORDING MENU 2	88
Motion compensation (image stabilizer) setting	88
Focus range setting	89
Focus mode setting	90
Light-measuring mode setting	90
ISO sensitivity setting	91
RECORDING MENU 3	92
White balance setting	92
Exposure setting	93
Subject chaser settings	94
High sensitivity mode setting	96
Digital zoom setting	96
Exposure compensation	97
Storage folder setting	98

PLAYBACK

PLAYBACK MENU 1	99
Slideshow settings	99
File protect setting	100
Resize	102
Rotate	102
PLAYBACK MENU 2	103
Correcting the image	103
Editing video clips	104
Printing instructions	113
FILE INFO DISPLAY	117

■ OPTION SETTINGS

DISPLAY THE OPTION SETTING MENU	118
INTRODUCTION TO THE OPTION SETTING MENU	119
Shortcut setting	125
TV output setting	128
File No. continued setting	132
Formatting (initializing)	134
CHECKING THE REMAINING CARD MEMORY	135
Checking the remaining number of images and video recording time	135
For audio recordings	136
CHECKING THE REMAINING BATTERY PACK CHARGE	137

■ OTHER DEVICES AND CONNECTIONS

CONNECTING TO A TV

CONNECTING TO A TV	139
Connecting to a video input terminal	140
Connecting to the HDMI terminal	140
PLAYING BACK ON A TV	141

CONNECTING TO A PRINTER

PRINTING	142
----------------	-----

■ APPENDICES

COMMONLY ASKED QUESTIONS	145
TROUBLESHOOTING	153
Camera	153
Notes regarding the Scene Select feature and filters	161
SPECIFICATIONS	163
Camera	163
Camera connectors	167
Battery life	167
Possible No. of Images/Possible Shooting Time/ Possible Recording Time	168
Concerning the multi-indicator	169
Supplied AC adaptor	170
Supplied Li-ion battery pack	170
Others	171
Before capturing those important shots, be sure to first take a test shot to confirm that your camera is set up and ready to go	172
HINTS FOR TAKING PICTURES	173

QUICK SEARCH BY OPERATION

Your camera has an abundance of convenient features and functions. From creating precisely the photo you want, to viewing images using various techniques, you can locate the exact operation for your purposes in the following table.

Shooting/recording		
Basic operation	Convenient functions	Additional functions
Getting started shooting/recording <ul style="list-style-type: none"> • "VIDEO CLIP RECORDING" on page 59 • "SHOOTING SINGLE SHOTS" on page 60 • "Sequential shots" on page 85 • "Audio recording" on page 82 	Log the date and time of your photos <ul style="list-style-type: none"> • "DATE AND TIME SETTING" on page 33 Zoom in on the subject <ul style="list-style-type: none"> • "MACRO-PHOTOGRAPHY (ZOOM)" on page 67 Close-up photography <ul style="list-style-type: none"> • "Focus range" (super macro mode) on pages 42 and 48 • "Select the focus setting" (super macro mode) on page 57 	For more accurate focus <ul style="list-style-type: none"> • "How to use the manual focus" (manual focus) on page 89 Set the focus to a narrow range <ul style="list-style-type: none"> • "Focus mode setting" on page 90 Reduce noise when recording <ul style="list-style-type: none"> • "NOISE REDUCTION setting" on page 122
Optimize the photo quality <ul style="list-style-type: none"> • "Select the recording size" on pages 42 and 56. • "Video setting" on pages 46 and 82 • "Still image setting" on pages 46 and 85 	Set the camera's color/contrast characteristics <ul style="list-style-type: none"> • "Image quality setting" on page 122 	
Capture fast-moving subjects <ul style="list-style-type: none"> • "Scene select" (sports mode) on page 46 Suppress camera shake effect <ul style="list-style-type: none"> • "Motion compensation (image stabilizer) setting" on pages 48 and 88 		

Shooting/recording

Basic operation

Convenient functions

Additional functions

Shoot in dark conditions

- “Exposure compensation” on page 97
- “Using the flash” on pages 42, 46 and 63
- “Scene select setting” (night view portrait mode/fireworks mode/lamp mode) on pages 46 and 86

Increase the camera's sensitivity

- “ISO sensitivity setting” on pages 48 and 91
- “High sensitivity mode setting” on pages 50 and 96

Photographing people

- “Scene select setting” (portrait mode/night view portrait mode) on pages 46 and 86
- “Filter setting” (cosmetic filter) on pages 46 and 86

Capture sharp images

- “Face chaser setting” on pages 50 and 95
- “Color chaser setting” on pages 50 and 94

Simplified operation for shooting/playback

- “SWITCHING BETWEEN THE RECORDING MODE AND PLAYBACK MODE” on page 35

Photographing landscapes

- “Scene select” (landscape mode) on page 46

Take a self-photo

- “Self-timer setting” on pages 46 and 87

Make images lighter or darker

- “Exposure compensation” on page 97
- “High sensitivity mode setting” pages 50 and 96

Measure the brightness of a specific area

- “Light-measuring mode setting” on pages 48 and 90

Adjust the camera's sensitivity

- “ISO sensitivity setting” pages 48 and 91

Change the color of the images

- “Filter setting” (monochrome filter/sepia filter) on pages 46 and 86

Make white appear natural

- “White balance setting” on pages 50 and 92

Playback		
Basic operation	Convenient functions	Additional functions
Getting started viewing images <ul style="list-style-type: none"> • "PLAYING BACK VIDEO CLIPS AND STILL IMAGES" on page 70 	Adjust the speaker volume <ul style="list-style-type: none"> • "PLAYBACK VOLUME" pages 51 and 75 Search for image/ audio files <ul style="list-style-type: none"> • "21-image display playback" on page 79 • "Selecting the playback folder" on pages 52 and 80 Magnify an image <ul style="list-style-type: none"> • "Magnifying (zooming in) the image" on page 81 	Change the angle of view <ul style="list-style-type: none"> • "Rotate" on pages 51 and 102 Reduce the photo size <ul style="list-style-type: none"> • "Resize" on pages 51 and 102
<ul style="list-style-type: none"> • "Audio playback" on page 84 	Adjust the speaker volume <ul style="list-style-type: none"> • "PLAYBACK VOLUME" on pages 51 and 75 	
Continuous playback <ul style="list-style-type: none"> • "SLIDESHOW PLAYBACK" on pages 44, 74 and 99 		
Adjust the monitor brightness <ul style="list-style-type: none"> • "Adjusting the monitor brightness" on page 61 • "BRIGHTNESS setting" on page 122 		
Playback on a TV <ul style="list-style-type: none"> • "PLAYING BACK ON A TV" on page 141 Set the TV system <ul style="list-style-type: none"> • "TV output setting" on pages 124 and 128 		

File managing/processing		
Basic operation	Convenient functions	Additional functions
Search for image/audio files <ul style="list-style-type: none"> • “21-image display playback” on page 79 • “Selecting the playback folder” on pages 52 and 80 		
Delete files <ul style="list-style-type: none"> • “DELETING FILES” on pages 44, 51 and 76 	Protect files from accidental erasure <ul style="list-style-type: none"> • “File protect setting” on pages 51 and 100 Format a card <ul style="list-style-type: none"> • “Formatting (initializing)” on pages 124 and 134 	
Delete a part of a video clip and join video clips <ul style="list-style-type: none"> • “Editing video clips” on pages 52 and 104 		
Specify the number of prints, index print, and date imprint <ul style="list-style-type: none"> • “Printing instructions” on pages 52 and 113 		
View the settings that were in effect when the image/audio files were recorded <ul style="list-style-type: none"> • “FILE INFO DISPLAY” on page 117 		

Using with a computer		
Basic operation	Convenient functions	Additional functions
Use the camera as a card reader <ul style="list-style-type: none"> • "SETTING THE CONNECTION MODE" on page 10 in the Xacti Software CD INSTRUCTION MANUAL • "USING AS A CARD READER" on page 12 in the Xacti Software CD INSTRUCTION MANUAL 		
Copy files from your camera to a computer <ul style="list-style-type: none"> • "Copy data from your camera to the computer" on page ix 		
Burn files copied to the computer onto a DVD <ul style="list-style-type: none"> • "Burn video clips onto a DVD" on page xiii 		
Playback <ul style="list-style-type: none"> • "About video clip files recorded with this camera" on page 8 in the Xacti Software CD INSTRUCTION MANUAL 		
Using as a webcam <ul style="list-style-type: none"> • "USING AS A PC CAMERA" on page 15 in the Xacti Software CD INSTRUCTION MANUAL 		
Record an image of the computer screen <ul style="list-style-type: none"> • "SCREEN CAPTURE" on page 17 in the Xacti Software CD INSTRUCTION MANUAL 		

CHECKING THE INCLUDED ACCESSORIES

- Xacti Software CD (CD-ROM) (page 4 in the Xacti Software CD INSTRUCTION MANUAL): 1



- Li-ion battery pack: 1

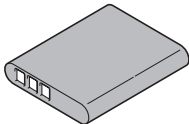

- AC adaptor: 1

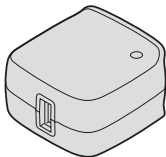

- Plugs: The number of included plugs is different depending on the region where the camera is sold.

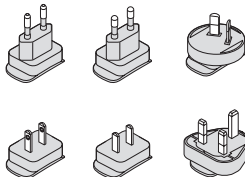

- Dedicated USB interface cable (page ix): 1

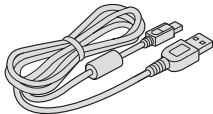

- Dedicated AV interface cable (page 140): 1

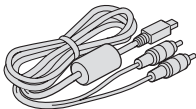

- Handstrap (page 13): 1
 - * To prevent from dropping the camera, be sure to attach the handstrap.

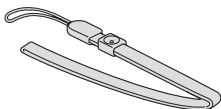

- SAFETY MANUAL (safety precautions booklet)
Please read this booklet carefully before using the camera.



- GUIDE FOR BASIC OPERATION

- QUICK GUIDE



- Obtaining the PDF instruction manual and cautions



How to use the accessories

■ Handstrap



About the power plug

A power plug suitable for the destination country is provided for the AC adaptor.

VPC-CA100EX VPC-CA100TA				
VPC-CA100GX				
VPC-CA100PX				
VPC-CA102				

■ How to attach

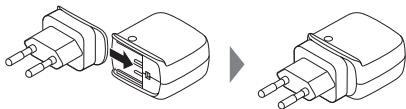

ABOUT THE CARD

Media cards that can be used with this camera

The type of card that can be inserted into and used with this camera is:

- SD Memory Card
- SDHC Memory Card
- SDXC Memory Card

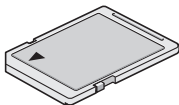

What “card” means in this manual

- In this manual, SD Memory Cards, SDHC Memory Cards and SDXC Memory Cards that can be used in this dual camera are referred to as “card”.

GETTING THE MOST OUT OF YOUR CAMERA

Your dual camera can record video clips in Full High Definition*. It includes an operation mode that lets even novice shutterbugs record and play back without getting flustered, as well as software with which you can easily create your original DVDs.

Waterproof capability

The camera is equipped to safely be used in water at a temperature of less than 40 °C (104°F), at a depth of less than 3.0 m (9.84 ft.), for up to approximately 60 minutes. You can enjoy taking pictures at the beach or by the pool.

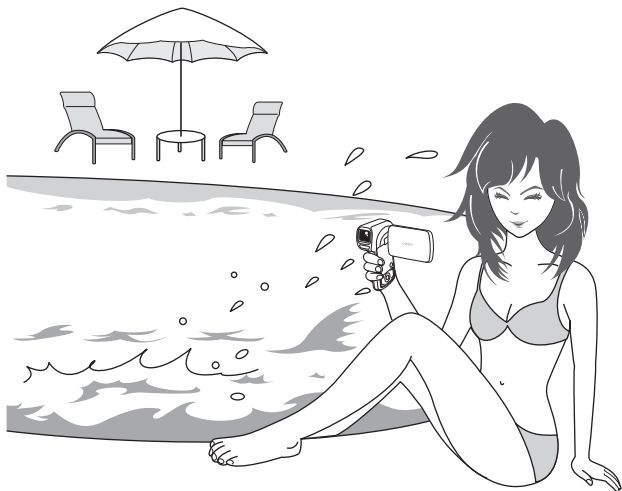

High-quality images with “Full High Definition^{*}” (pages 46 and 56)

Your camera can capture full high definition (full HD) 1920 × 1080-pixel video clips. Also, the H.264/MPEG-4 AVC standard is used for formatting video files. You get both compact file size and high picture quality in one high-performance camera.

* “Full High Definition” by SANYO Dual Camera signifies recording at a resolution of 1920 pixels horizontally × 1080 pixels vertically.

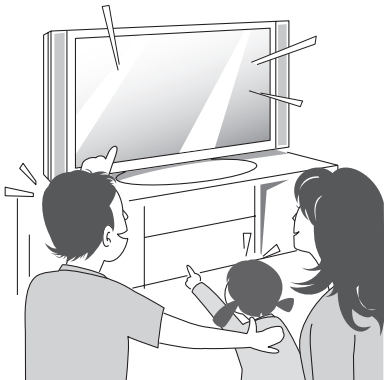

Includes SIMPLE mode for quick-and-easy operation (page 36)

Select from two recording/playback modes: the “SIMPLE mode” for users new to the camera, and the “NORMAL mode” for full use of all the camera’s many features and functions.

Example:



<SIMPLE Mode Recording Menu>

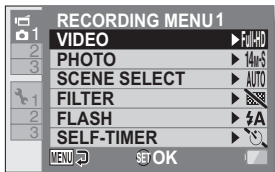

<NORMAL Mode Recording Menu>

Image stabilizer for sharp pictures (pages 48 and 88)

Your camera can compensate for the camera shake that results in blurry images when you try to capture a fast-moving subject or when you zoom in on a subject.



Capture clear images of the targeted subject (pages 50 and 94)

Both the color chaser feature to target a specific color, and the face chaser feature to capture clear face shots, are provided.

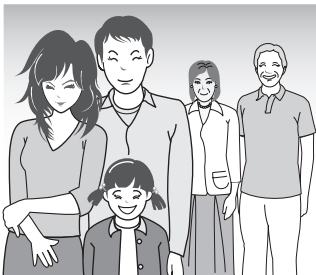

Eye-Fi smart

By inserting a commercially sold Eye-Fi card (SD card with wireless LAN) in your camera, you can easily upload photos to your computer, a sharing site, etc. automatically via a Wi-Fi network. Also, you can transfer video files if your Eye-Fi card has a video upload function. Instructions for the Eye-Fi transfer feature can be found at the following website:

<http://sanyo.com/xacti/english/>

SYSTEM MAP

You can connect the camera to various devices to expand its capabilities.

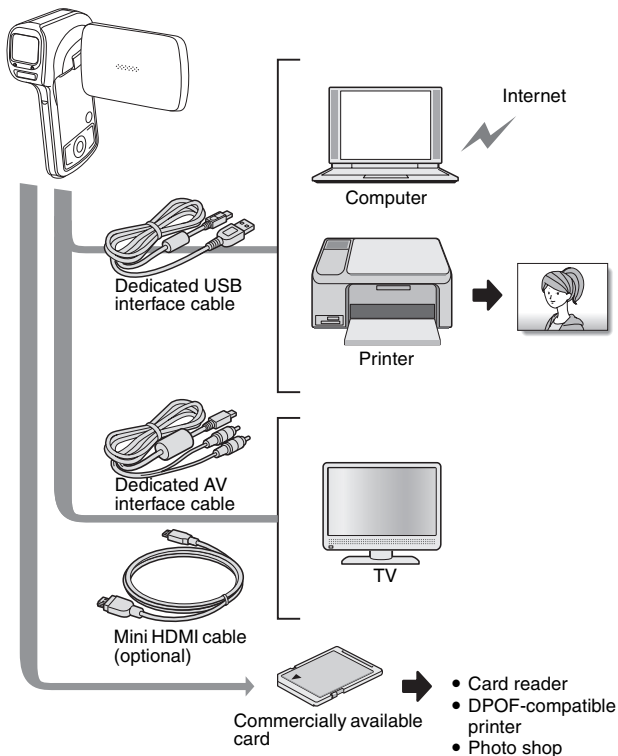

PARTS NAMES

Front

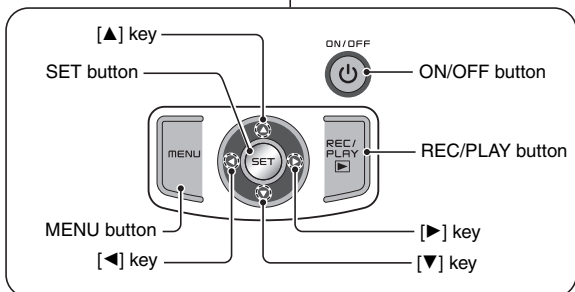
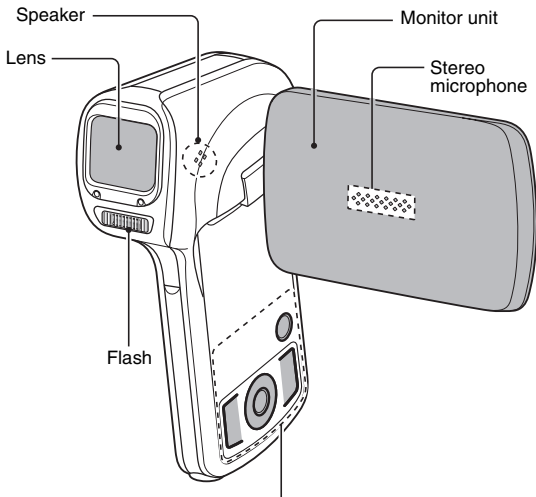

There are places in the camera where water might accumulate, but this will not affect its waterproof properties.

To care for your camera after using in water, see page 69.

Rear

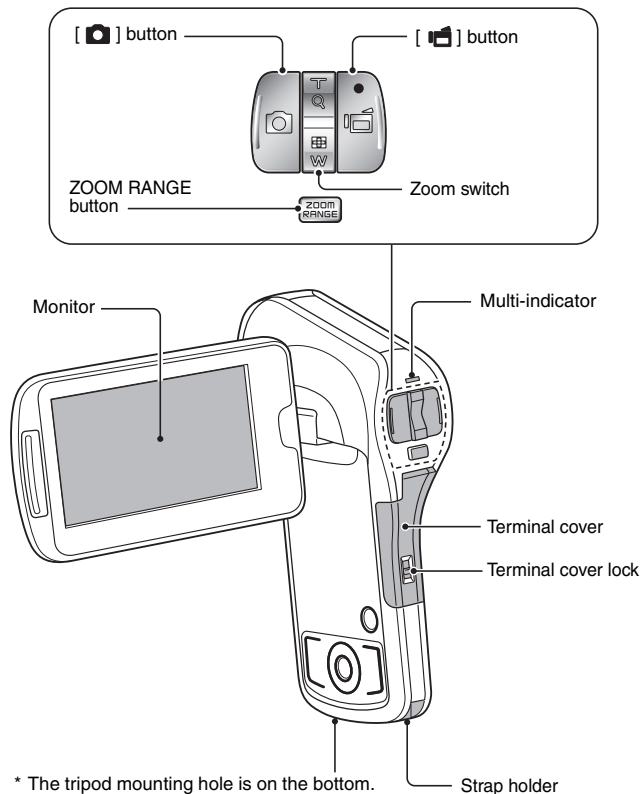

INSTALLING THE CARD

Be sure to format a newly purchased card or one that was used in another device before using it in your camera (pages 124 and 134). If an unformatted card is used, the card itself may become unusable.

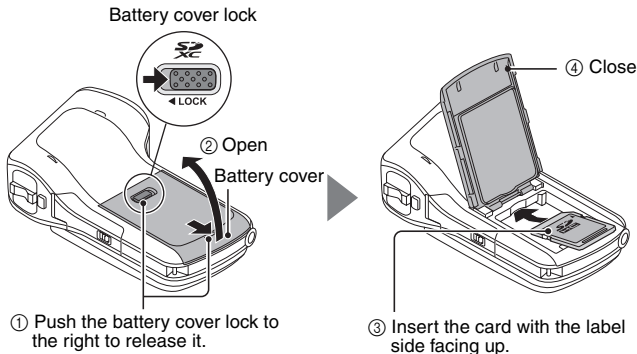

<When removing the card...>

- To remove the card, press it in, and then release. The card will protrude slightly, and you can then pull it out.

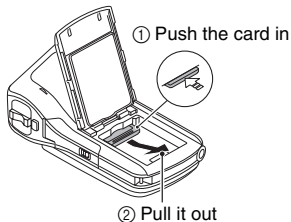

- ⑤ Push the battery cover lock to the left to lock it.
The colored label is visible when the battery cover lock is not completely closed. Be sure to close the lock completely so that the colored label is not visible.

Colored label

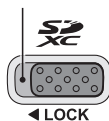

CAUTION

Close the battery cover securely

- If the battery cover is not closed or is not closed completely, the camera will no longer be waterproof. When closing the battery cover, make sure that no foreign object such as sand, hair, dust, etc. is caught in the rubber seal.

Do not attempt to forcibly remove the card

- Doing so may damage the card or the stored files.

If the multi-indicator is flashing red...

- Never remove the card when the multi-indicator is flashing red, as doing so may result in loss of files stored in the card.

HINT

Shooting without a card installed

- When a card is installed, images are recorded to and played back from the card. When no card is installed, images are recorded to and played back from the camera's internal memory. When the camera is turned on with no card installed, the internal memory icon  is shown on the monitor to let you know that the images you capture will be saved to the camera's internal memory.

CHARGING THE BATTERY PACK

Please charge the supplied battery pack before using it. Install the battery pack in the camera, and connect the AC adaptor to charge the battery. Power to the camera can also be supplied from a power outlet when the AC adaptor is connected.

1 Open the battery cover.

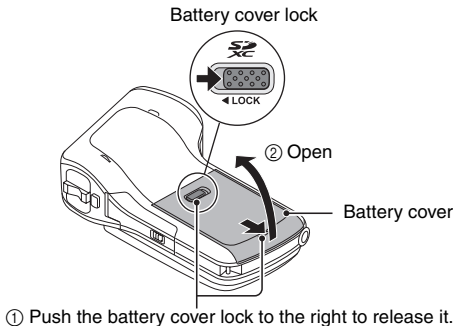

2 Insert the battery pack, then replace the battery cover.

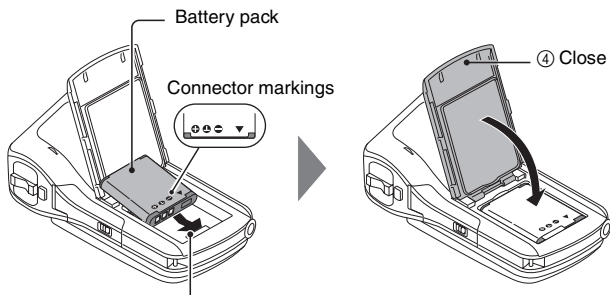

③ Insert the battery pack while matching the connector markings.

⑤ Push the battery cover lock to the left to lock it. The colored label is visible when the battery cover lock is not completely closed. Be sure to close the lock completely so that the colored label is not visible.

Colored label

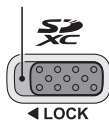

3 Affix the appropriate plug (supplied) to the AC adaptor.

- Use the plug that is appropriate for your region.

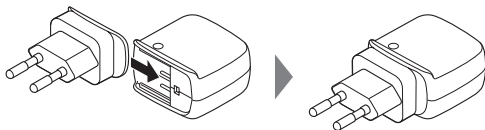

4 Use the dedicated USB interface cable (supplied) to connect the camera and the AC adaptor, and then connect the AC adaptor to a power outlet.

- Recharging takes place only when the camera is turned off, or when the power save function or the sleep function has been activated. Recharging does not take place when the camera is in the recording mode or playback mode.

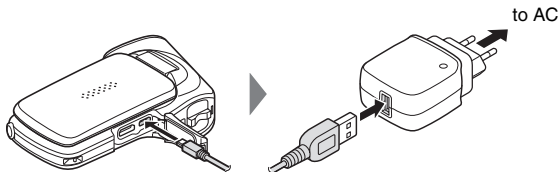

<During charging...>

- During charging, the multi-indicator is lit red. When charging is completed, the indicator turns off.
- The multi-indicator flashes red if the battery pack is defective or is not installed correctly. Make sure that the battery pack is correctly installed.
- The charging time is approx. 120 minutes.

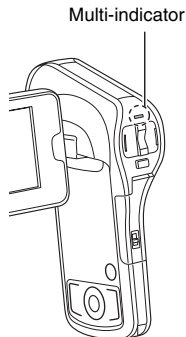

CAUTION

Use only the supplied accessories

- Please use only the supplied AC adaptor and dedicated USB interface cable. Using an AC adaptor or USB cable other than those supplied may cause a fire.

Close the battery cover and terminal cover securely

- If any cover is not closed or is not closed completely, the camera will no longer be waterproof. When closing a cover, make sure that no foreign object such as sand, hair, dust, etc. is caught in the rubber seal.

Do not charge the battery pack immediately after the camera has been in continuous use for a long time

- The battery pack becomes hot when the camera is used continuously for a long time. If you attempt to charge the battery pack in this state, the multi-indicator may flash red and it may not be possible to charge the battery pack. Wait until the battery pack has cooled down before attempting to charge it.

Does the battery pack appear swollen?

- The lithium-ion battery used in this camera may expand slightly when stored in a hot environment or repeatedly used, but this is not a safety hazard. However, a battery that is difficult to insert because it has become swollen may then be impossible to extract from the battery compartment. In this case, please discontinue its use and replace it with a new battery.

Do not use the battery with the outer covering or label removed

- Doing so may result in malfunction.

HINT**About the internal backup battery**

- This camera's internal battery serves to maintain the date and time settings, as well as the shooting settings. The backup battery will be fully charged when the battery pack is kept in the camera continuously for about 2 days. In the fully charged state, the backup battery will maintain the camera settings for about 7 days.

When not using the camera for a long time, remove the battery pack

- A small amount of power is still used even if the camera is turned off, and it is therefore recommended that the battery pack be removed from the camera if it is not going to be used for a long time. Note that when the battery pack is removed for a long period, the time and date settings may be cleared. Before using your camera again, be sure to confirm that the camera settings are correct.

Recharging when connected to the USB terminal (page 6 in the Xacti Software CD INSTRUCTION MANUAL)

- The battery can be recharged while the camera is connected to a computer. During recharging, the camera is recognized by the computer as a separate drive; however, data cannot be exchanged.
- The time it takes to recharge will differ depending on the operating condition of the camera and the computer.
- Connect the dedicated USB interface cable to the USB connector on your computer. Do not connect it to the USB connector on the monitor or the keyboard, or to the USB hub. Correct operation of the USB interface cable cannot be guaranteed if it is connected to a connector other than the computer's USB connector.
- If the camera is not going to be used for an extended period of time, please disconnect the dedicated USB interface cable from the camera.



About recharging

Recharging takes place only when the camera is turned off, or when the power save function or the sleep function has been activated. Recharging does not take place when the camera is in the recording mode or playback mode.



About the temperature alert icon

During camera use, if the temperature of the battery or inside the camera (excluding the battery) rises, a temperature alert icon  will appear as described below.

■ When the battery or internal camera (excluding battery) temperature rises during use

- During camera use, if the temperature of the battery or inside the camera (excluding the battery) rises, a  icon lights on the monitor. It is still possible to record and play back even when the  icon is lit; however it is advised that you discontinue use as soon as possible and turn the camera off.
- If the temperature rises further, the  icon will start to flash, and the camera will turn off automatically.

The camera cannot be turned on until the temperature has dropped (or as long as the  icon remains flashing). Please wait until the temperature has dropped before resuming use.

- During video recording, a countdown indicator will show the time starting about 15 seconds before shutdown. When the indicator shows 0 seconds, recording stops.
- If the camera is turned off while the temperature is high (that is, while the  icon is flashing), it cannot be turned on again until the temperature has dropped (or as long as the  icon remains flashing).

TURNING THE CAMERA ON AND OFF

Turning on the camera

- 1 **Open the monitor unit, and press the ON/OFF button for at least 1 second.**
 - If you briefly press the ON/OFF button, once, the camera will switch to the power save mode.
 - If you press the REC/PLAY button for at least 1 second, the camera turns on in the playback mode.

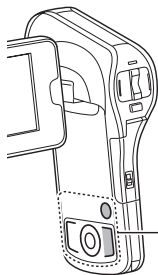
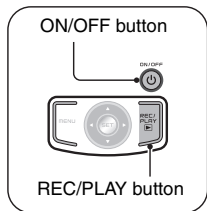

Turning off the camera

- 1 **Press the ON/OFF button for at least 1 second.**
 - The camera turns off.

Turning on the camera when the power save (sleep) mode is active

In order to preserve battery pack power, the power save (sleep) function will automatically turn off the camera after about 1 minute of no use during shooting, or about 5 minutes of no use during playback (factory-preset setting).

- When the power save mode is active, you can restore the power by any of the following methods:
 - **Press the ON/OFF button.**
 - **Press the [] button.**
 - **Open the monitor unit.**
- After the power save mode has been active for about 1 hour, the camera will switch to the standby mode. In this case, you can restore the power by pressing the ON/OFF button, or by closing and then opening the monitor unit.
- When the AC adaptor is connected, the power save mode will become active about 5 minutes after the camera is turned on (factory-preset setting).
- The user can specify the time elapsed before the power save mode is activated (page 124).
- When the camera is connected to a computer or printer, the camera turns off after about 12 hours.

HINT**To immediately activate the power save mode**

- Press the ON/OFF button briefly to activate the power save function.

About the standby mode

- To turn off the camera only briefly, you can close the monitor unit to put the camera in the standby mode. The standby mode uses almost no power. When the monitor unit is opened again, the camera turns on immediately and you are ready to shoot or view images without any delay.

CAUTION**If the  icon appears...**

- When a picture is taken, the date and time it was captured are recorded with it. If the date and time settings have not been completed (page 33), the date and time cannot be recorded with the captured images. For this reason, immediately after the camera is turned on, the “Set date and time” reminder briefly appears, after which the  icon is shown on the Recording Screen. To have the date and time recorded with the images, please complete this setting before capturing images.

DATE AND TIME SETTING

The camera will record the date and time an image or audio recording is taken so that you can display them during playback. Therefore, before capturing images, make sure the correct date and time are set.

- To correct the date and time setting, please see under **HINT** on page 34.

Example: To set the clock to 7:30 p.m. on December 24, 2010

1 Turn on the camera (page 30), and press the SET button.

- The Clock Set Screen appears.
- Follow the procedures below to enable or disable the date display during playback, to set the display format for the date, and to set the date and time.
- To display the Recording or Playback Screen, press the MENU button 2 times.

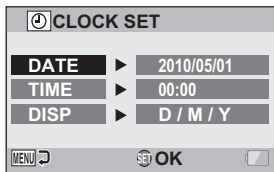

2 Set the date.

- ① Select "DATE".
- ② Press the SET button.
 - The Set Date Screen appears.
- ③ Set the date to "2010/12/24".
 - The date is set in the following order: Set the year → Set the month → Set the day.
 - Press [◀] or [▶] to select year, month or day. Press [▲] or [▼] to increase or decrease the number.
- ④ Press the SET button.

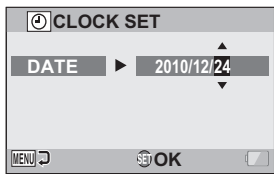

3 Set the clock.

- ① Select "TIME".
- ② Press the SET button.
 - The Set Time Screen appears.
- ③ Set the time to "19:30".
 - The time is set in the following order: Set the hour → Set the minute.
 - A 24-hour clock is used for the time display.
- ④ Press the SET button.

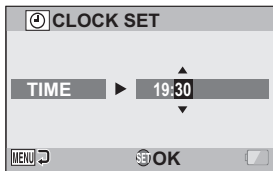

4 Set the order in which the date is displayed during playback.

- ① Select "DISP".
- ② Press the SET button.
 - The Set Date Format Screen appears.
- ③ Press [▲] or [▼].
 - The date display order changes.
- ④ Press the SET button.

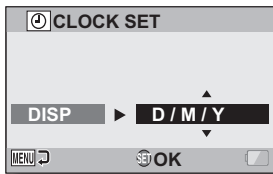

5 Press the MENU button.

- The date and time setting is completed.
- To display the Recording or Playback Screen, press the MENU button.

HINT

- Under normal conditions, while the battery pack is being replaced, an internal battery will maintain the date and time settings. However, there is a small chance the settings may be lost (the backup will last for about 7 days). It is recommended to check that the date and time settings are still correct after replacing the battery pack and before shooting or recording of any type (follow step 1).

To correct the date and time settings

- ① Turn on the camera.
- ② Display the Option Setting Menu 1 (page 118).
- ③ Select "CLOCK SET" and press the SET button.
 - The screen to set the date and time appears.
 - The current date and time settings are shown.
- ④ Select the line you wish to change, and make the correction.

SWITCHING BETWEEN THE RECORDING MODE AND PLAYBACK MODE

Switch between the recording mode (for recording) and the playback mode (for viewing your recorded images).

1 Turn on the camera (page 30).

2 Press the REC/PLAY button.

- The mode changes.
- The mode changes each time the REC/PLAY button is pressed.

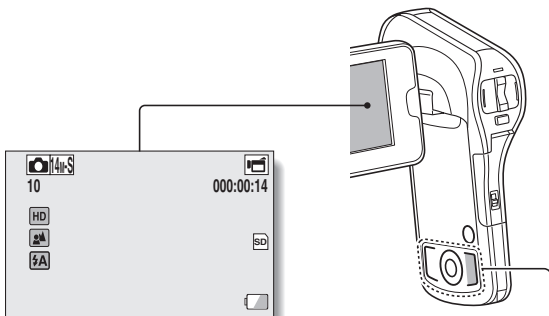

<Example of the recording mode>

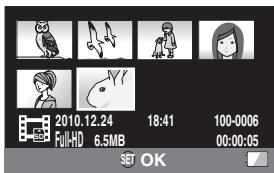

<Example of the playback mode>

SWITCHING THE OPERATING MODE

The “SIMPLE mode” comprises only those functions that are most often used and necessary to operate the camera, while the “NORMAL mode” enables full use of all the camera’s many functions. Select the mode that is suitable for your purposes.

Switching between the SIMPLE and NORMAL modes

- 1 Turn on the camera (page 30).**
 - The previous mode is active.
- 2 Press the MENU button.**
 - The Menu Screen for the active mode appears.

- 3 Select the operating mode icon, and press the SET button.**
 - Switch from the SIMPLE mode to the NORMAL mode, or from the NORMAL mode to the SIMPLE mode.
 - Press the MENU button to cancel the Menu Screen.

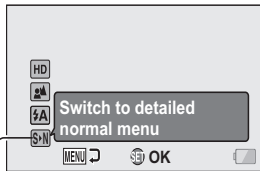

Operating mode icon

<SIMPLE Mode Menu Screen>



Operating mode icon

<NORMAL Mode Menu Screen>

Accessing/exiting the SIMPLE/NORMAL Mode Menu Screen

- 1 Set the camera to the recording or playback mode (page 35).
- 2 Select the desired operating mode (page 36).
- 3 If the Menu Screen is not displayed, press the MENU button.
 - The Menu Screen appears.
 - To cancel the Menu Screen, press the MENU button.

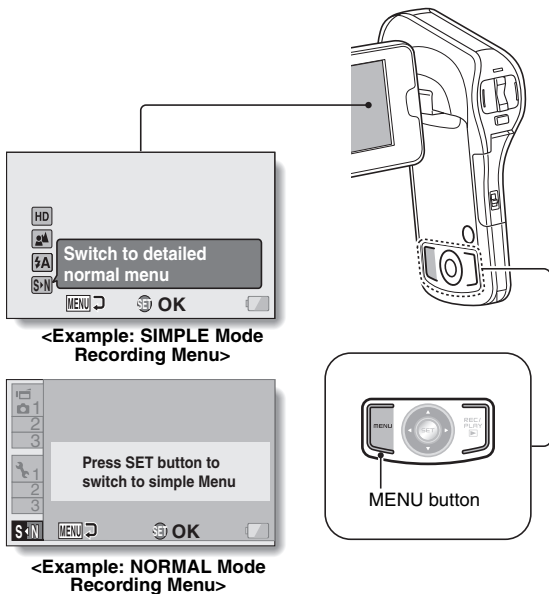

Using the SIMPLE Mode Menu

- 4** Press [▲] or [▼] to select the item you wish to change, and press the SET button.
- The Setting Screen for the selected item appears.

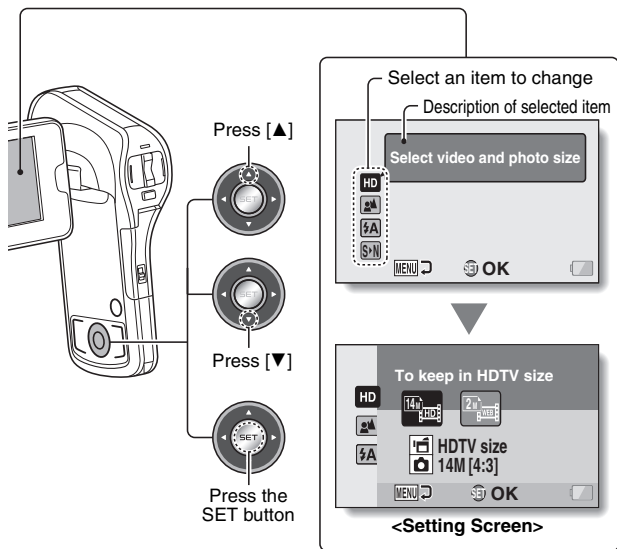

Using the NORMAL Mode Menu

- 4** Press [▲] or [▼] to select a tab.
- The Menu Screen for the selected tab appears.

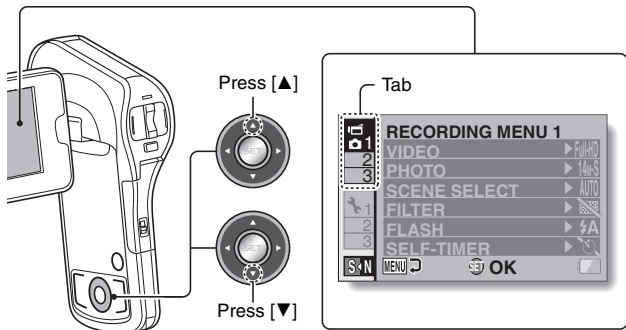

- 5** Press [▶].

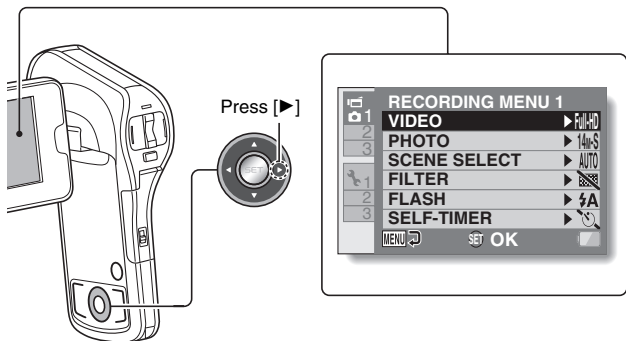

6 Press [▲] or [▼] to select the item you wish to change, and press the SET button.

- The Setting Screen for the selected item appears.
- To return to the Menu Screen, press the MENU button.

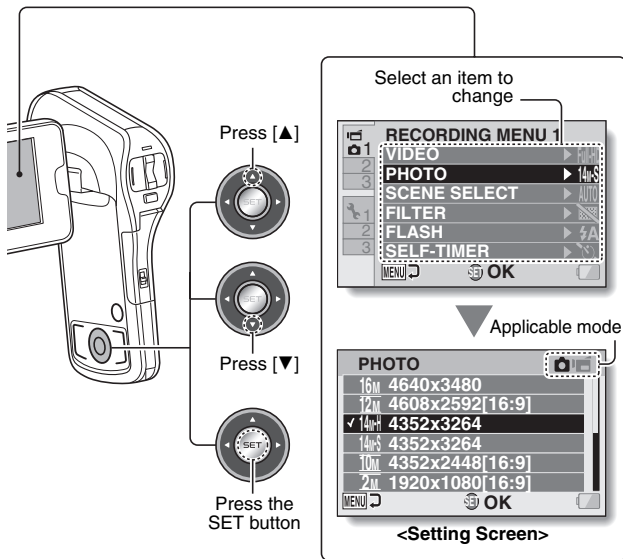

HINT

About the applicable mode indicator

- This indicator shows the shooting mode(s) for which the selected setting is effective.

: This setting is effective during still image shooting.

: This setting is effective during video clip recording.

: This setting is effective during still image shooting and video clip recording.

Overview of the SIMPLE Mode Setting Screen

SIMPLE Mode Recording Menu

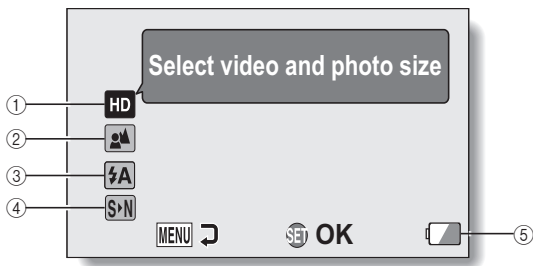

① **Recording size (page 56)**

- Select the video clip size to record.



: The video clip size is 1920 × 1080 pixels, recorded at 60 fields/sec. The captured still image size is 4352 × 3264 pixels (4:3 aspect ratio).



: The video clip size is 640 × 480 pixels, recorded at 30 frames/sec. The captured still image size is 1600 × 1200 pixels (4:3 aspect ratio).

② **Focus range (page 57)**

- Select the focus range that corresponds to the distance to the subject.



: The camera automatically focuses on the subject within a range of 50 cm (19.69 in.) to infinity (normal).



: The camera focuses on a subject within a range of 1 cm (0.39 in.) to 80 cm (31.50 in.) (super macro).

③ **Flash (page 63)**

- Specify how the flash will operate.



: The camera detects the subject brightness and uses the flash only when necessary.



: The flash operates with every image captured regardless of the conditions.



: The flash does not operate even in dark situations.

④ **S/N (page 36)**

- Set to the NORMAL mode.

⑤ **Remaining battery power indication (page 137)**

SIMPLE Mode Playback Menu

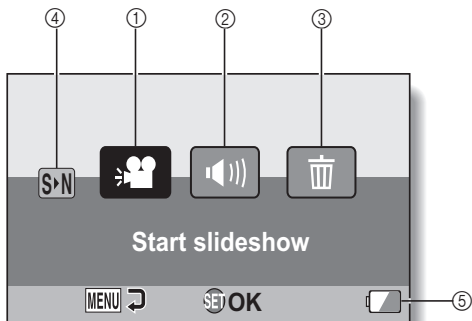

- ① **Slideshow (page 74)**
 - Specify the slideshow settings and play the slideshow.
- ② **Playback volume (page 75)**
 - Adjust the volume for video clip and audio file playback.
- ③ **Delete (page 76)**
 - Delete files.
- ④ ** (page 36)**
 - Set to the NORMAL mode.
- ⑤ **Remaining battery power indication (page 137)**

Overview of the NORMAL Mode Setting Screen

NORMAL Mode Recording Menu

<Tab 1>

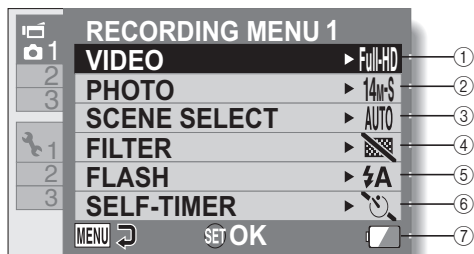



① **Video clip settings (page 82)**

<HD mode>

: Record at 1920 × 1080 pixels, 60 fields/s (60i).

: Record at 1920 × 1080 pixels, 30 fps (30p).

: Record at 1280 × 720 pixels, 60 fps (60p).

: Record at 1280 × 720 pixels, 30 fps (30p).

<SD mode>

: Record at 640 × 480 pixels, 30 fps.

: Make an audio recording.

② **Still image settings (page 85)**

<Single-shot>

: Image size is 4640 × 3480 pixels.

: Image size is 4608 × 2592 pixels (16:9 aspect ratio).

: Image size is 4352 × 3264 pixels (low compression).

: Image size is 4352 × 3264 pixels (normal compression).

: Image size is 4352 × 2448 pixels (16:9 aspect ratio).

: Image size is 1920 × 1080 pixels (16:9 aspect ratio).

: Image size is 1600 × 1200 pixels.

: Image size is 1280 × 720 pixels (16:9 aspect ratio).

: Image size is 640 × 480 pixels.

<Sequential shots>

: 4352 × 3264-pixel sequential shots.

: 1600 × 1200-pixel sequential shots.

③ **Scene select (page 86)**

: Full auto setting

: Sports mode

: Portrait mode

: Landscape mode

: Night view portrait mode

: Snow & beach mode

: Underwater mode

: Fireworks mode

: Lamp mode

④ **Filter (page 86)**

: No filter

: Cosmetic filter

: Monochrome filter

: Sepia filter

⑤ **Flash**



: The camera will detect the subject brightness and use the flash only when necessary.



: The flash will operate with every image captured regardless of the conditions.

: The flash will not operate even in dark situations.

⑥ **Self-timer (page 87)**

: Self-timer is off.



: Shooting begins 2 seconds after the [] or [] button is pressed.



: Shooting begins 10 seconds after the [] or [] button is pressed.

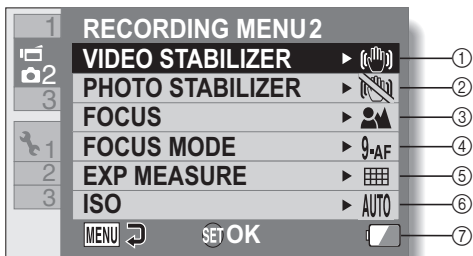

⑦ **Remaining battery power indication (page 137)**

<Tab 2>





- ① **Video stabilizer (page 88)**
 - Compensate for camera shake during video clip recording.
 - : Record with image stabilizer on.
 - : Record without image stabilizer.

- ② **Photo stabilizer (page 88)**
 - Compensate for camera shake during still image shooting.
 - : Shoot with image stabilizer on.
 - : Shoot without image stabilizer.

- ③ **Focus range (page 89)**
 - Select the focus range that corresponds to the distance to the subject.
 - : The camera automatically focuses on the subject with a range of 50 cm (19.69 in.) to infinity (normal).
 - MF**: The focus can be set manually.
 - : The camera focuses on the subject within a range of 1 cm (0.39 in.) to 80 cm (31.50 in.) (super macro).

- ④ **Focus area (page 90)**
 - 9-AF**: 9-point range finder focus
 - S-AF**: Spot focus

- ⑤ **Light-measuring mode (page 90)**
 - : Multi-section light measuring
 - : Center-weighted light measuring
 - : Spot light-measuring

- ⑥ **ISO sensitivity (page 91)**
 - AUTO**: Sensitivity is set automatically (video clip recording: ISO 50 to 800; still image shooting: ISO 50 to 400)
 - 50**: Sets sensitivity to ISO 50
 - 100**: Sets sensitivity to ISO 100
 - 200**: Sets sensitivity to ISO 200
 - 400**: Sets sensitivity to ISO 400
 - 800**: Sets sensitivity to ISO 800
 - 1600**: Sets sensitivity to ISO 1600
 - The indicated ISO value is the standard output sensitivity.

- ⑦ **Remaining battery power indication (page 137)**

<Tab 3>

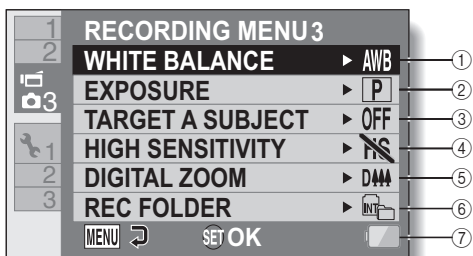



① **White balance (page 92)**

AWB: White balance is automatically adjusted depending on the ambient lighting (auto).

: For shooting in sunny conditions (fair).

: For shooting in overcast conditions (cloudy).

: For shooting under fluorescent lighting (fluorescent).

: For shooting under incandescent lighting (incandescent).

: For setting the most accurate white balance (one push).

② **Exposure (page 93)**

P: The exposure is set automatically.

S: Set the shutter speed manually.

A: Set the aperture manually.

M: Set the aperture and shutter speed manually.

③ **Subject chaser (page 94)**

Automatically target a specific color with the color chaser function, or capture sharp face shots with the face chaser function.

: Enable face chaser.

: Enable color chaser.

OFF: Disable face chaser and color chaser.

④ **High sensitivity mode (page 96)**

HS: Increased sensitivity.

: Normal sensitivity.

⑤ **Digital zoom (page 67)**

: Enable the digital zoom.

: Disable the digital zoom.

⑥ **Rec folder setting (page 98)**

⑦ **Remaining battery power indication (page 137)**

NORMAL Mode Playback Menu

<Tab 1>

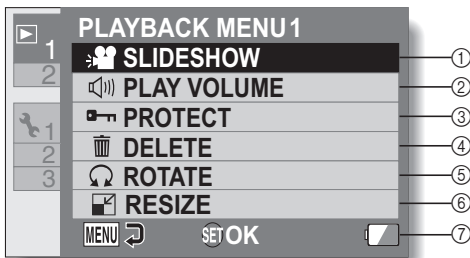

- ① **Slideshow (page 99)**
 - Specify the slideshow settings and play the slideshow.
- ② **Playback volume (page 75)**
 - Adjust the volume for video clip and audio file playback.
- ③ **Protect (page 100)**
 - File protect setting (delete prohibited)
- ④ **Delete (page 76)**
 - Delete files.
- ⑤ **Rotate (page 102)**
 - Rotate a still image.
- ⑥ **Resize (page 102)**
 - Reduce the resolution of a still image.
- ⑦ **Remaining battery power indication (page 137)**



- ① **Edit photo (page 103)**
 - Repair the “red-eye” caused by the flash, or enhance the contrast (still images only).
- ② **Video clip edit (page 104)**
 - Edit video clips.
- ③ **Printing instructions (page 113)**
 - Specify the printing instructions (DPOF settings).
- ④ **Select folder (page 80)**
 - Select a folder to play back.
- ⑤ **Copy**
 - Copy files from the card to the internal memory, or vice versa.
- ⑥ **Remaining battery power indication (page 137)**

BEFORE TAKING PICTURES

For best results

Hold the camera securely, keeping your elbows close to your body and making sure the camera is stable.

Correct hold



Incorrect hold



A finger is blocking the lens or flash.

<Holding the camera>



Example 1:

Grip the camera by wrapping the fingers of the right hand, from the little finger to the middle finger, around the camera, and hook the index finger above the lens.



Example 2:

Grip the camera by wrapping the fingers of the right hand, from the little finger to the index finger, around the camera.

Make sure that the lens and flash unit are not blocked by your fingers or the handstrap.

<Caution>

- Due to the characteristics of the camera, the outer surface may become warm during use, but this does not indicate a malfunction.
- If the camera starts to feel uncomfortably hot during use, you might temporarily discontinue use until it cools down, or try holding it in your other hand for a while.
Please use a tripod or other support when using the camera for a long time.

Using the autofocus

The autofocus will work in almost all situations; however, there are certain conditions that may cause the autofocus function to not work properly. If the autofocus function is not working properly, set the focus range to capture images (page 57).

■ Conditions that may cause incorrect focus

The following examples are some of the situations where the autofocus function may not work.

- **Subjects with low contrast, very bright subjects at the center of the image or dark subjects or locations**

Use the focus-lock function to lock the focus on an object with contrast at the same distance as the desired subject.



- **Subjects without vertical lines**

Use the focus-lock function to lock the focus while framing the subject vertically, then re-orient the camera to compose a horizontally framed image.

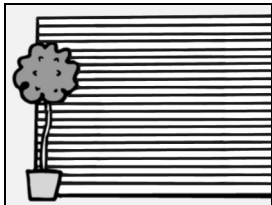

The following examples are some of the situations where the autofocus function may work, but not as desired.

- **When both near and far objects are present**

Use the focus-lock function to lock the focus on an object at the same distance as the desired subject, then reposition the camera to compose the picture.



- **Fast-moving subjects**

Use the focus-lock function to lock the focus on an object at the same distance as the desired subject, then reposition the camera to compose the picture.

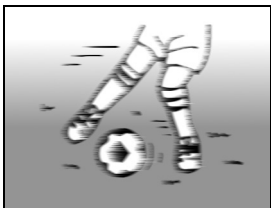

HINT

- Still images can be rotated when they are played back (pages 51 and 102).
- When the [] button is pressed halfway, the image in the monitor may waver vertically. This is the result of internal image processing and is not a malfunction. This wavering is not recorded and will not affect your images in any way.
- When the optical zoom is used or when the autofocus is operating, the image may appear to waver, but this is not a malfunction.

Select the recording size

The larger the image size (number of pixels), the better the image quality will be, but the file size will also be larger. Select the image quality that is correct for the intended purpose.

- 1 Display the **SIMPLE Mode Recording Menu** (page 37), select the recording size setting, and press the **SET** button.

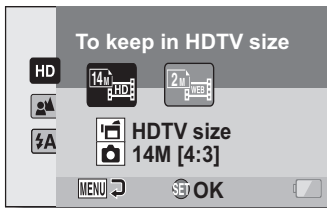

- : The video clip size is 1920 × 1080 pixels, recorded at 60 fields/sec.
The captured still image size is 4352 × 3264 pixels (4:3 aspect ratio).
- : The video clip size is 640 × 480 pixels, recorded at 30 frames/sec.
The captured still image size is 1600 × 1200 pixels (4:3 aspect ratio).

- 2 Select the desired recording size, and press the **SET** button.
 - This completes the recording size setting.

Select the focus setting

Select the focus range corresponding to the distance between the camera and the subject.

- 1 Display the **SIMPLE Mode Recording Menu** (page 37), select the focus setting, and press the **SET** button.

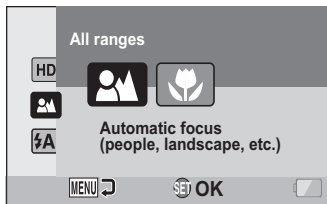

- : The camera automatically focuses on the subject within a range of 50 cm (19.69 in.) to infinity (normal).
- : The camera focuses on a subject within a range of 1 cm (0.39 in.) to 80 cm (31.50 in.) (super macro).

- 2 **Select the desired focus range, and press the SET button.**
 - This completes the focus range setting.

Hints for taking pictures

Muting the operation sounds

- The audio guidance that sounds when you operate the camera can be muted (page 120).

Where are the image and audio files saved?

- All the image and sound files are recorded on the card installed in the camera, or in the camera's internal memory.

Taking pictures in backlight conditions...

- When taking pictures with the light coming from behind the subject, due to the characteristics of the lens, ghost patterns (flare phenomenon) may appear in the captured image. In this situation, it is recommended that you avoid taking pictures with the subject lit from behind.

While the image files are being recorded...

- While the multi-indicator is flashing red, the image files are being written to the memory, during which time it is not possible to capture another image. Another image can be captured after the flashing red indicator turns off. However, even when the multi-indicator is flashing red, depending on the camera's internal memory remaining capacity, in some cases the next image can be captured about 2 seconds after shooting.

VIDEO CLIP RECORDING

- 1 Turn on the camera (page 30), and set it to the recording mode (page 35).

- 2 Press the [] button.

- Recording begins.
- It is not necessary to keep the [] button pressed while recording.
- When the remaining recording time available for the currently recording clip becomes little, a countdown of the remaining recording time appears on the display.

- 3 End the recording.

- Press the [] button again to stop recording.

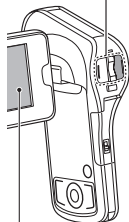

Recording time





Available recording time remaining

SHOOTING SINGLE SHOTS

Capture a still image (single-shot).

- 1 Turn on the camera (page 30), and set it to the recording mode (page 35).

- 2 Press the [] button.

- ① Press the [] button halfway.

- The autofocus operates, and the image is focused (focus lock).

- ② Continue to gently press the [] button all the way.

- The shutter releases and the image is captured.
- You can view the captured image on the monitor by keeping the [] button depressed when you capture the image.

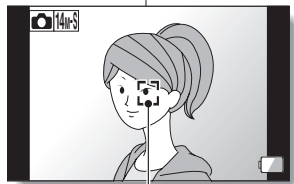
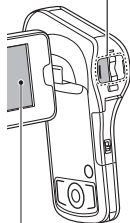
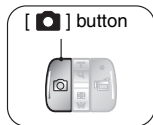
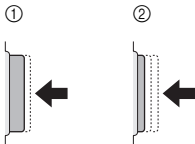

Target mark

HINT

Adjusting the monitor brightness



- While the Recording Screen is active, you can quickly access the screen for adjusting the brightness of the monitor by pressing the MENU button for at least 1 second.

What is the camera focusing on?

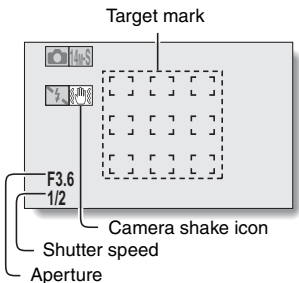
- A target mark  on the monitor shows the area the camera is focusing on.
- The camera automatically determines the correct focus by measuring from 9 different focus points within the shooting area. If the target mark is at a position that is different from the point you wish to focus on, you can refocus, for example, by changing the shooting angle.
- The large target mark appears when the camera focuses on a wide area in the center of the screen.



The focus and exposure can be locked (in the NORMAL mode)

- By assigning an operation shortcut to an arrow key (pages 122 and 125), you can set the autofocus or the exposure to a fixed setting. When the exposure setting is fixed, the  icon appears on the monitor; when the autofocus setting is fixed, the  icon appears on the monitor.
- When the focus range (pages 46 and 86) setting or scene select setting is changed, the focus lock is released.

The shutter speed and aperture are displayed (in the NORMAL mode)

- The shutter speed and aperture settings are shown on the Recording Screen. You can use them as a reference when shooting.

If the camera shake icon  appears... (in the NORMAL mode)

- During still image shooting, if the shutter speed is slow and the possibility that the image may be blurred due to camera shake becomes high, the camera shake icon may appear on the monitor. In this case, use a tripod to stabilize the camera when shooting, or set the flash operation mode to automatic (pages 42 and 63).
- When shooting with the scene select function set to the fireworks  mode, the camera shake icon always appears, but this is normal.

Does it seem to take a long time to save images?

- When shooting in dimly lit conditions, it may take some time to save the data to the card.

Using the flash

The flash is not only used for photographing under dark conditions, but is also convenient for example when the subject is in shadow or lit from behind. The flash is available only when shooting single-shot still images.

1 Display the SIMPLE Mode Recording Menu (page 37), select the flash setting, and press the SET button.

- The screen to select the flash operation appears.

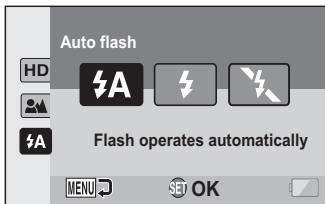

- : The camera detects the subject brightness and uses the flash only when necessary.
- : The flash operates with every image captured regardless of the conditions.
- : The flash does not operate even in dark situations.

2 Select the desired flash operation, and press the SET button.

- This completes the flash operation setting.

3 Press the [] button to take the picture.

CAUTION**Do not touch the flash unit when shooting**



- The flash unit becomes very hot and may cause a burn. Avoid touching the flash unit when shooting.

HINT

- The flash cannot be used during video clip recording.
- By assigning an operation shortcut to an arrow key (pages 122 and 125), you can change the flash mode from the Recording Screen (NORMAL mode).

SHOOT A STILL IMAGE WHILE RECORDING A VIDEO CLIP

You can capture a still image (a single-shot) while recording a video clip.

- 1** Turn on the camera (page 30), and set it to the recording mode (page 35).
- 2** Press the [] button.
- 3** When you see a scene you'd like to capture as a still image, press the [] button.
- 4** Press the [] button to end the video clip recording.

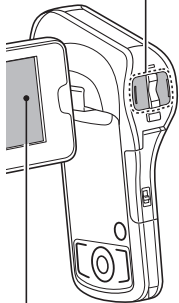
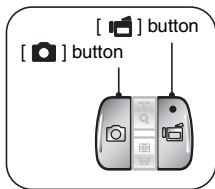

HINT

- When shooting a still image while recording a video clip, the flash does not operate.
- The photo stabilizer (pages 48 and 88) is inoperative.
- When the remaining video recording time becomes approximately 50 seconds, it will no longer be possible to capture a still image while recording a video clip. The exact remaining recording time at which this occurs will differ depending on the subject and on the recording size (page 56), as well as on the video clip recording mode (page 82). If you intend to capture a still image while recording a video clip, it is suggested that you take note of the remaining video recording time.

About the recording size of still images

- The size of a still image captured during video clip recording depends on the video clip recording size.

Video clip recording size setting	Still image recording size
Full-HD Full-SHQ	2M
HD-HR HD-SHQ	0.9M
TV-SHQ	0.3M

- It is not possible to capture sequential shots.

MACRO-PHOTOGRAPHY (ZOOM)

Your camera has two zoom functions: optical zoom and digital zoom.

1 Point the camera lens at the subject.

2 Push the zoom switch toward [T/🔍] or [W/📐] to compose the desired image.

[T/🔍]: Zoom in on the subject.

[W/📐]: Zoom out.

- When the zoom switch is pushed, the zoom bar appears on the monitor.
- When the optical zoom factor is at maximum, zooming stops temporarily. When the zoom switch is pushed toward the [T/🔍] side again, the mode changes to the digital zoom mode and zooming continues.

3 Take the picture.

For video clip recording, see page 59.

For shooting single shots, see page 60.

For shooting sequential shots, see page 85.

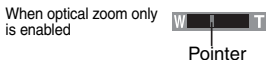
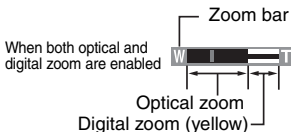
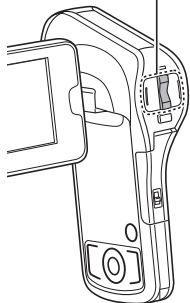
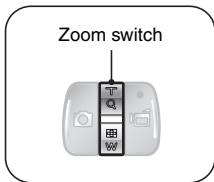

HINT**When recording video clips at a high magnification**

- When recording video clips at a high magnification, a moving subject or moving camera can cause camera shake, resulting in a distorted playback image. This phenomenon is due to the characteristics of the CMOS sensor and is not a malfunction.
- It is recommended that you use a tripod to stabilize the camera when recording video clips at a high magnification.

About the “Advanced Zoom”

- During video clip recording, the “Advanced Zoom” function makes it possible to electronically magnify the image with no image degradation, and increase the magnification to a maximum 6x.

When the ZOOM RANGE button is pressed...

- The magnification is approximately doubled (double-range zoom). Press the button again to return to normal magnification.
- The [W] icon is shown on the Recording Screen during normal magnification, and a [T] icon on the double-range zoom Recording Screen (Normal mode).

AFTER USING THE CAMERA IN WATER

After using the camera in water, wash it with fresh water and dry it completely.

1 Turn off the camera, and close the battery cover and terminal cover securely.

2 Wash the camera with fresh water.

- Fill a shallow basin with fresh water, and immerse the closed camera for about 5 minutes. Rotate the monitor unit several times to clean it completely.
-

3 Dry the camera.

- Use a dry cloth to wipe off any drops adhering to the camera, and leave it to dry completely in a well-ventilated place away from direct sunlight.
 - Do not use a hair dryer or the like to dry the camera. Exposing the camera to high temperatures may cause the camera and/or waterproof seal to become deformed.
-

HINT

About the handstrap

- Wash the handstrap in fresh water after detaching it from the camera.
- After washing, leave it to dry in a place away from direct sunlight.

PLAYING BACK VIDEO CLIPS AND STILL IMAGES

1 Set the camera to the playback mode (page 35).

2 Select the image to play back.

- Use the arrow keys to move the orange frame to the file you wish to play back.
- The image information for the framed image is shown at the bottom of the screen.

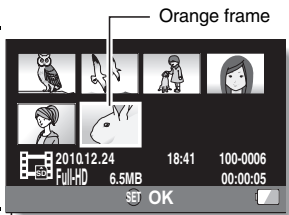

3 Press the SET button.

- The image you selected in step 2 is displayed fullscreen.
- If a video clip was selected, playback begins.

<To return to the screen to select playback files>

Press [▼].

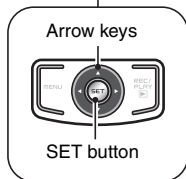
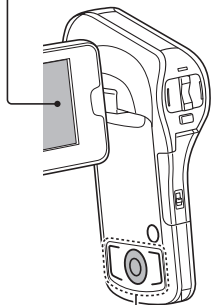

Video clip playback operation

To do this...		Do this
Normal forward playback		Press the SET button.
Stop playback		During playback, press [▼].
Pause		During playback, press the SET button or press [▲]. During accelerated playback, press [▲].
To play back one image at a time (single-frame step)	During forward playback	After pausing playback, press [▶].
	During reverse playback	After pausing playback, press [◀].
Slow playback	During forward playback	After pausing playback, press and hold [▶].
	During reverse playback	After pausing playback, press and hold [◀].
To accelerate playback	Forward playback	During forward playback, press [▶]. • The playback speed changes each time [▶] is pressed, as follows: Normal playback → 2× → 5× → 10× → 15× Press [◀] to resume normal playback speed.
	Reverse playback	During forward playback, press [◀]. • The playback speed changes each time [◀] is pressed, as follows: 15× ← 10× ← 5× Press [▶] to resume normal playback speed.
Return to normal playback speed		Press the SET button.
Adjusting the volume		Louder: During playback, push the zoom switch toward the [T] side. Softer: During playback, push the zoom switch toward the [W] side.



HINT

If the appears on the playback Screen...

- The  icon appears when playing back a file that was saved in segments (page 83).

How to save one frame from a video clip as a still image

- 1 Play back the video clip. Pause the playback at the point you wish to “snap” a photo.

- 2 Press the [] button.
 - The screen to select the aspect ratio of the still image appears. Select the desired aspect ratio, and press the [] button. Note, however, that if the video clip aspect ratio is 4:3, you cannot select 16:9.

HINT

The file size for a video clip is very large

- Therefore, be aware that if the video clip is uploaded to a computer to be played back, the computer may not be able to play back the video fast enough, making it appear jerky. (The video will always be displayed properly on the camera monitor or a television.)
- Depending on the card, recording may end even before the possible recording time indicated.

Display the video clip playback point

- During video clip playback, press the MENU button for at least 1 second to display a bar showing the current playback point in the video clip.
- Press the MENU button for about 1 second to cancel the bar.

CAUTION

During video clip playback, the sound of a motor is audible...

- During recording, the sound of the optical zoom movement or autofocus movement was recorded. This is not a malfunction.



If no audio is heard...

- The audio is not played back when the video clip is played back in the frame-by-frame, slow-motion, fast playback or reverse playback mode.

SLIDESHOW PLAYBACK

You can play back files in succession with the “slideshow playback” feature.

- 1** Display the **SIMPLE Mode Playback Menu (page 37)**, select the **slideshow setting**, and press the **SET** button.

- : Play back all files.
- : Play back video clips and audio files.
- : Play back still image files.



- 2** Select the type of file to play back, and press the **SET** button.

- Slideshow playback begins.
- To stop slideshow playback, press the SET button or MENU button.

HINT

About the slideshow settings

- The slideshow settings can be changed from the **NORMAL Mode Playback Menu (page 99)**.

PLAYBACK VOLUME

Adjust the playback volume for video clips and audio files.

- 1** Display the **SIMPLE Mode Playback Menu** (page 37), select the playback volume setting, and press the **SET** button.
 - The volume control bar appears.

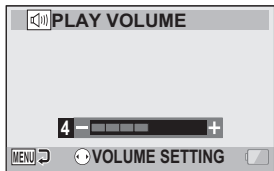

- 2** Press [**◀**] or [**▶**] to set the volume, and press the **SET** button.
 - The playback volume is set, and the display returns to the **SIMPLE Mode Playback Menu**.

HINT

The volume can be adjusted during playback

- During video clip or audio file playback, if you push the zoom switch toward [**T/**] or [**W/**], the volume control bar will appear, allowing you to adjust the volume.

In the **NORMAL mode**

- When you select "PLAY VOLUME" from the **NORMAL Mode Playback Menu** and press the **SET** button, the volume control bar appears.

DELETING FILES

You can delete files if you no longer need them. You can delete single files, selected files or all the files at one time.

Delete single/delete all/delete folder

- 1** Display the SIMPLE Mode Playback Menu (page 37), select the delete setting, and press the SET button.

DELETE SINGLE:

Deletes one file at a time.

DELETE SELECTED:

Deletes the selected files (page 77).

DELETE ALL:

Deletes all files.

DELETE FOLDER:

Delete the folder and all the files in the folder.

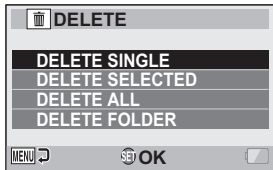

- 2** Select the desired delete mode, and press the SET button.

- The Delete Confirmation Screen appears.

<DELETE SINGLE>

- Press [◀] or [▶] to select the file you wish to delete.
- There is no confirmation screen when deleting single files. Please make sure that the displayed image is one you wish to delete.

<DELETE ALL>

- Press [◀] or [▶] to confirm the files to delete.

<DELETE FOLDER>

- Press [▲] or [▼] to select the folder you wish to delete.

3 Select "DELETE", and press the SET button.

<DELETE SINGLE>

- The currently displayed file is deleted.
- To delete other files, select the files, select "DELETE" and press the SET button.

<DELETE ALL, DELETE FOLDER>

- The Delete Confirmation Screen again appears. To delete the files, select "DELETE" and press the SET button. Then select "YES" and press the SET button, and the files will be deleted. When file delete is completed, "No image" is shown.

Delete selected

Delete selected files.

1 Display the SIMPLE Mode Playback Menu (page 37), select the delete setting, and press the SET button.

2 Select "DELETE SELECTED", and press the SET button.

- The screen to select files to delete appears.

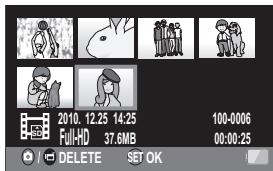

3 Select an image you wish to delete.

- Use the arrow keys to move the orange frame to the file you wish to delete.

4 Press the SET button.

- The selected file is marked with the delete icon [].
- Up to 100 files can be selected.
- To cancel a delete selection and remove the delete icon from a file, move the orange frame to the marked file and press the SET button.

5 Press the [] or [] button.

- The Confirm Delete Screen appears.

6 Select “YES”, and press the SET button.

- The selected files are deleted.

HINT**In the NORMAL mode**

- When you select “DELETE” from the NORMAL Mode Playback Menu and press the SET button, the Delete Screen appears.

CAUTION

- Files that are protected from accidental delete cannot be deleted. To delete protected files, set the protect setting for the files to off (pages 51 and 100), and then follow the file delete procedure.

PLAYBACK MODES

21-image display playback

- 1** Display the image you wish to play back.
- 2** Push the zoom switch toward the [W/🎮] side.
 - The 21-image display appears.
- 3** Select the image to play back.
 - Use the arrow keys to move the orange frame to the desired image, and press the SET button.
 - Pushing the zoom switch toward the [T/🔍] side will show the 8-image display.
 - If the zoom switch is pushed toward the [W/🎮] side while the 21-image display is shown, the display changes to the screen to select the playback folder (page 80).
 - It is not possible to perform the file delete or file protect settings on the 21-image display.

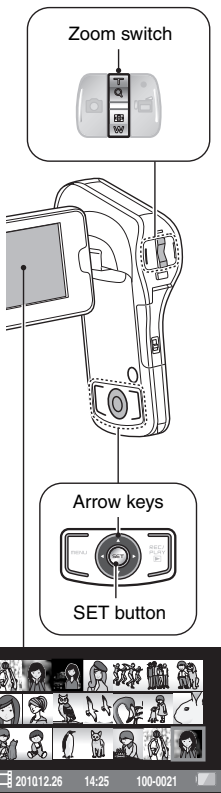

Selecting the playback folder

If the card contains multiple folders, you can select from which folder you would like to play back.

1 Display the Playback Screen.

2 Push the zoom switch toward the [W/☒] side twice.

- The screen to select the playback folder appears.
- If the zoom switch is pushed toward the [T/🔍] side, the camera changes to the 21-image display (page 79).

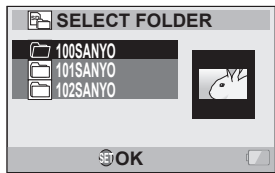

3 Press [▲] or [▼] to move the orange frame to the desired folder, and press the SET button.

- The files in the selected folder are displayed in the Playback Screen.

HINT

In the NORMAL mode

- When you select "SELECT FOLDER" from the NORMAL Mode Playback Menu and press the SET button, the screen to select the playback folder appears.

Magnifying (zooming in) the image

1 Display the image that you want to magnify.

- For a video clip, pause playback at the place you want to magnify.

2 Push the zoom switch toward the [T/🔍] side.

- Magnification is enabled.
- The image is magnified, and the central portion of image is displayed.
- Use the arrow keys to view different parts of the magnified image.

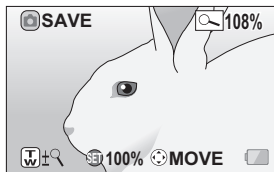

To magnify:

Magnification increases each time the zoom switch is pushed toward the [T/🔍] side.

To return to normal size:

Magnification decreases each time the zoom switch is pushed toward the [W/🔍] side.

- Press the SET button to return to the normal (100%) view.

HINT

The magnified portion of the image can be saved as a separate image

- Press the [📷] button. The magnified portion is saved as a new still image.

RECORDING MENU 1

Video setting

When recording a video clip, smoother motion and better image clarity can be achieved by a higher pixel rate (resolution) and a faster frame rate. However, the file size will also be proportionately larger, requiring longer times to edit and store. It is recommended that you adjust the settings to those suitable for the desired purpose. Note that this menu is also used for recording audio only files.

CAUTION

When editing video clips...

- In order for video clips to be joined, they must have been photographed in the same mode.
- Video clips that were photographed in different modes cannot be joined.

Audio recording



■ Audio recording

1 Select , and press the SET button.

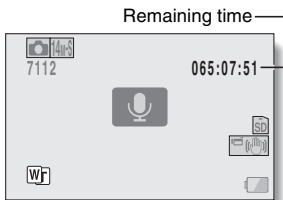
- The audio recording mode is enabled.
- The menu display is canceled if the MENU button is pressed.



2 Press the [] button.

- Audio recording begins. During recording,  appears in the monitor. It is not necessary to continue pressing the [] button while recording.

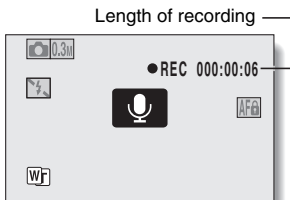

3 End the recording.

- Press the [] button again to stop recording.

HINT

You can capture a still image during an audio recording

- Press the [] button during audio recording to capture a **0.3M** still image.

About files saved in segments

- When the video setting is set to a voice memo  that exceeds about 13 hours, the recorded file is saved once, and the recording continues in a new file. For other video settings, when the file size exceeds 4 GB, the recorded file is saved once, and the recording continues in a new file. (These 4 GB segments are automatically created. The recording session continues until you stop recording, but voice memo recording is temporarily interrupted while the file is being saved.)

■ Audio playback

1 Select an audio file, and press the SET button.

- Playback begins.

To do this...		Do this
Normal playback	Start playback	Press the SET button.
	Pause	Press the SET button. Press [▲].
	Stop playback	Press [▼].
Fast forward/ fast reverse	Fast forward	During playback, Press [▶]. Each time [▶] is pressed, the speed increases. If [◀] is pressed, during fast forward, the speed decreases.
	Fast reverse	During playback, press [▶]. Each time [◀] is pressed, the speed increases. If [▶] is pressed, during fast reverse, the speed decreases.
	Pause	Press [▲].
	Return to normal playback	Press the SET button.
Volume adjustment	Louder	During playback, push the zoom switch toward the [T/🔍] side.
	Softer	During playback, push the zoom switch toward the [W/📷] side.

CAUTION

If no audio is heard...

- The audio is not played back when the audio recording is played back in the fast playback or fast reverse mode.

Still image setting

For still images, you can select either the 4:3 or 16:9 horizontal to vertical aspect ratio. This menu is also used for shooting sequential shots.

Sequential shots

1 Select  or , and press the SET button.

- The camera changes to the sequential shots mode.

2 Press the [] button.

- Shooting begins. Shooting continues as long as the [] button is kept pressed.

HINT

What is the maximum number of images in a sequential shots sequence?

: 22 images

: 14 images

- If you continue shooting even after the maximum number of images has been captured, recording does not stop.
- If you continue shooting after the maximum number of images has been captured, subsequent captured images will overwrite the sequence already captured, beginning from the first image in the sequence.

About the focus when shooting sequential shots

- When sequential shots are captured, the autofocus operates when the [] button is pressed halfway, fixing the focus.

Can the flash be used?

- The flash does not operate when shooting sequential shots.

Did the angle of view change?

- When shooting sequential shots, the angle of view relative to that of still image shooting may change.







About the PHOTO NR (page 122) setting

- During sequential shots shooting, the PHOTO NR setting automatically turns OFF.

Scene select setting

You can select from various preset settings (aperture, shutter speed, etc.) for specific shooting conditions.



HINT

- To return to normal photography, select **AUTO** from the scene select menu, and press the SET button.
- When capturing images using the lamp , fireworks  or night view portrait  setting, use a tripod or other method to stabilize the camera.
- In the sequential shots mode, it is not possible to select night view portrait , fireworks , or lamp .
- A table showing the limitations for settings corresponding to scene select icons other than **AUTO** is on page 161.

Filter setting

The filter feature changes image characteristics such as color tones, to apply unique effects to the photographed image.

HINT







- To return to normal photography, select  from the filter menu, and press the SET button.
- A table showing the limitations for settings corresponding to filter icons other than  is on page 162.

Self-timer setting



By assigning an operation shortcut to an arrow key (pages 122 and 125), you can set the self-timer from the Recording Screen.

HINT

To pause or cancel the self-timer function...

- If the [] button or [] button is pressed again before the shutter is released, the self-timer countdown temporarily stops. Press the [] button or [] button one more time to restart the self-timer.
- To cancel self-timer photography, select the  icon from the self-timer menu, and press the SET button.
- The self-timer is automatically reset to off  after the power save mode is activated and the camera turned off.

When is selected...

- When the [] button or [] button is pressed, the multi-indicator will blink for about 10 seconds, and then the image is captured. Also, 4 seconds before the shutter releases, the indication shown in the illustration appears on the monitor.

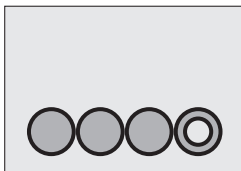



RECORDING MENU 2

Motion compensation (image stabilizer) setting

Your camera can minimize a jittery picture by compensating for unintentional hand motion.

HINT

If the motion compensation does not seem to be working...

- Due to the mechanical characteristics of this function, it may not be possible for the camera to compensate for violent motion.
- If the digital zoom (page 67) is being used, the large magnification factor may make it difficult for the motion compensation function to work correctly.
- When the scene select function is set to night view portrait  or lamp , the motion compensation effect may be insignificant.

Can't set the "photo stabilizer" setting?

- The photo stabilizer is automatically turned off  after any of the following operations.
 - Setting the exposure to **S**, **A** or **M** (pages 50 and 93).
 - Setting the still image NR (noise reduction) setting (page 122) to "ON".
 - Starting video clip recording.
 - Setting the camera to the sequential shots mode (pages 46 and 85).

When motion compensation is enabled,

- The following icons are shown on the monitor:



 The video stabilizer is active

 The photo stabilizer is active

 Both the video stabilizer and the photo stabilizer are active

Did the scene select setting change?

- When the photo stabilizer is set to , if the scene select setting is , it will automatically change to **AUTO**.

Focus range setting

How to use the manual focus

- 1 Select **[MF]**, and press the **SET** button.
 - The focus distance adjustment bar appears.

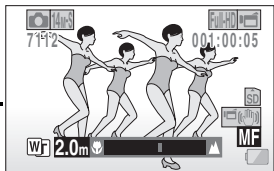

- 2 Press **[◀]** or **[▶]** to adjust the focus distance, and press the **SET** button.
 - The focus distance is set, and you are returned to the Recording Screen.

HINT

About the focus range

- The focus distance indication shows the distance between the center of the lens and the subject.
- In some cases there may be a slight variance between the distance (numerical figure) you set in the manual focus mode and the actual distance.

About zoom movement when using the manual focus

- If the focus distance is set to 70 cm (27.56 in.) or less, the zoom changes to the largest setting that is suitable for that focus distance.
- When the focus distance is set to 70 cm (27.56 in.) or less, the zoom will function only within the range at which the image is focused.

About the super macro mode

- When the focus range is set to super macro , the zoom is temporarily set to the wide end.
- By assigning an operation shortcut to an arrow key (pages 122 and 125), you can change the focus range setting from the Recording Screen.

Focus mode setting

When the spot focus setting is selected, the focus mark + appears in the center of the monitor.

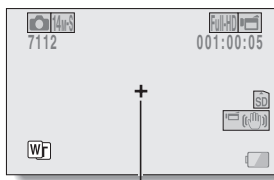

Focus mark

Light-measuring mode setting

When spot light-measuring is selected, the light-measuring spot mark □ appears in the center of the monitor.

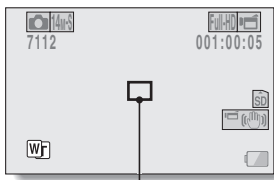

Light-measuring spot mark

ISO sensitivity setting

With the initial settings, the ISO sensitivity is automatically set according to the brightness of the subject. However, the ISO sensitivity can be set to a fixed setting.

HINT

- By setting a higher ISO sensitivity, you can set faster shutter speeds and capture images in darker locations, but noise in the captured images may increase or the images may be irregular.
- By assigning an operation shortcut to an arrow key (pages 122 and 125), you can change the ISO setting from the Recording Screen.

CAUTION

Does the image appear to flicker when recording a video clip?

- If recording a video clip under fluorescent lights with the ISO sensitivity set to **400** or higher, a noticeable flicker may appear in the image.

RECORDING MENU 3

White balance setting

This camera automatically adjusts the white balance under most lighting conditions. However, if you want to specify the lighting conditions or change the overall tone of the image, the white balance can be manually set.

How to use the one push setting

- 1 Select the  icon.
- 2 Fill the entire screen with a plain white card (or piece of paper, etc.), and press the SET button.
 - This completes the white balance setting.

HINT

To cancel the white balance setting

- Select **AWB**, and then press the SET button.

Exposure setting

The shutter speed and aperture size can be set individually.

1 Select the desired icon from the exposure menu, and press the SET button.

<If **[S]**, **[A]** or **[M]** was selected>

- ① Press [**▲**] or [**▼**] to select aperture value or shutter speed.
- ② Press [**◀**] or [**▶**] to change the setting for the selected parameter.

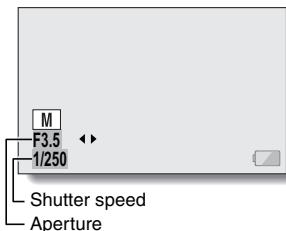

2 Press the SET button.

- This completes the exposure setting.

HINT

- To prevent the effects of camera shake at slow shutter speeds, it is recommended to use a tripod or other method to stabilize the camera.
- A slow shutter speed may be useful for photographing in a darker environment, but noise in the image may be increased.
- To minimize noise in the image, complete the noise reduction setting (page 122).
- The exposure setting automatically becomes **[P]** if the scene select function is active.
- In the sequential shots mode, the shutter speed is faster than 1/15 sec.
- Even if the shutter speed is set to slower than 1/29 sec., the shutter speed during video clip recording is 1/30 sec.
- If the exposure setting is set to **[S]**, **[A]** or **[M]**, by assigning an operation shortcut to an arrow key (pages 122 and 125), you can select the **[S]**, **[A]** or **[M]** exposure setting from the Recording Screen.

Subject chaser settings

Adjust the settings to automatically target a specific color with the color chaser function, or capture sharp face shots with the face chaser function.

Shooting with the color chaser function (still images only)

1 Set the color chaser setting to .

- A target mark (+) appears in the center of the monitor.
-

2 Move the target mark to the desired subject, and press the SET button.

- When the subject is successfully targeted, a target frame icon (blue ) appears superimposed on the subject.

<To cancel the color chaser operation>

- While the target frame icon is displayed, press the SET button.







<If the subject is not successfully targeted>

- The target mark continues to be displayed. Press the SET button once more, and try to engage the target again.
-

3 Press the [] button.



- The image is captured at the moment the [] button is pressed.

Shooting with the face chaser function

- 1 Set the face chaser setting to .**
 - When the subject is successfully targeted, a green double-frame appears superimposed on the subject.
- 2 When capturing a still image, press the [] button halfway.**
- 3 Press the [] or [] button.**
 - <To capture a still image>**
 - Gently press the [] button all the way to capture the photo.
 - <To record a video clip>**
 - Recording begins when the [] button is pressed.
 - During recording, an orange frame appears superimposed on the subject.

CAUTION

About recording with the subject chaser

- The chaser function does not work while the digital zoom is being used.
- The chaser function does not work when zooming in or out.
- The chaser function may not work when the subject in the monitor is relatively small or appears dark.
- If the scene select function setting was fireworks  or landscape , it automatically changes to **AUTO**.

When using the face chaser function

- The light measuring mode changes to multi-section light measuring.

High sensitivity mode setting

When you shoot in the high sensitivity mode, the captured image appears even brighter than that specified by the ISO sensitivity and exposure compensation settings.

CAUTION

Limitations of the high sensitivity mode

- When the shutter speed is reduced to create a bright image, video clip motion will appear uneven during playback.
- When shooting in a dark environment, the autofocus and auto exposure may not function effectively.

Digital zoom setting

This setting allows you to specify whether or not the digital zoom is enabled during zoom shooting.

HINT

- The digital zoom does not function in the following situation:
When the still image mode is set to **16M** or **12M**.

Exposure compensation

By assigning the exposure compensation operation shortcut to an arrow key (pages 122 and 125), you can make the image lighter or darker when capturing images.

1 Assign the operation shortcut to an arrow key (pages 122 and 125).

2 Press the arrow key to which the operation shortcut was assigned.

- The exposure compensation bar appears.

3 Press [◀] or [▶] to adjust the exposure.

- The exposure compensation numerical value is shown at the left end of the exposure compensation bar.
- The exposure compensation can be set to a value from -1.8 EV to +1.8 EV.
- The exposure compensation bar is canceled when the MENU button or the SET button is pressed.

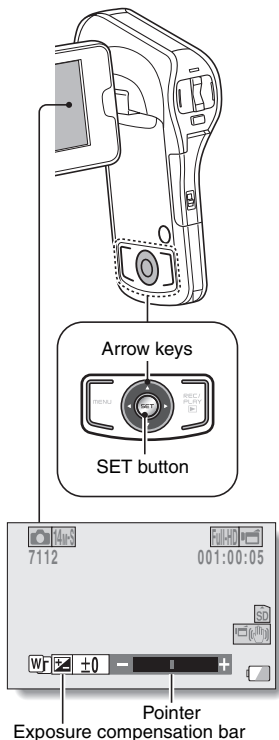

HINT

The exposure compensation setting is canceled in the following cases:

- When the pointer is set to the center position.
- When the camera is set to the playback mode.
- After the power is turned off.
- When the camera is set to the standby mode.

Storage folder setting

Create or select a recording folder (a folder in which to store recorded files).

1 Select "REC FOLDER", and press the SET button.

<Create a new folder>

- Select "CREATE NEW FOLDER".

<Select an existing folder>

- Select the desired folder number.



2 Press the SET button.

- This completes the create/select folder setting.
- If you created a new folder, it automatically becomes the selected recording folder.

CAUTION

When an existing folder cannot be selected or a new one created...

- A folder cannot be selected if it was created using a different device, or if it already contains the maximum number of files.

PLAYBACK MENU 1

Slideshow settings

Specify the settings for playing back files continuously in a “slideshow” format. In a slideshow of still images, you can set the transition time, transition effects and BGM.

Changing a setting

1 Select the item you wish to change, and press the SET button.

2 Press [▲] or [▼] to change the setting.

3 Press the SET button.

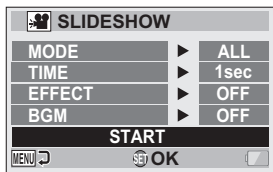

Begin the slideshow

- 1** Select “START” and press the SET button.
- Slideshow playback begins.
 - To stop slideshow playback, press the SET button or MENU button.

HINT

BGM for video clips?

- When video clips are played back in a slideshow, the recorded audio track is played back; the BGM is not played.

File protect setting

Prevent accidental erasure of image and audio files.

Protect files one by one

1 Display the file that you want to protect from accidental erasure, and display the **NORMAL Mode Playback Menu** (page 37).

2 Select “**PROTECT**” and press the **SET** button.

3 Select “**PROTECT SINGLE**” and press the **SET** button.

- “**LOCK**” appears.
- If the protect mode has already been enabled for the file, then “**UNLOCK**” appears.

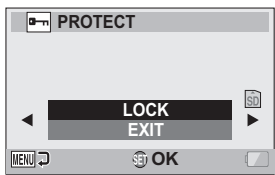

4 Select “**LOCK**” and press the **SET** button.

- The protect mode is set for the file.
- The protect mark  indicates that the file is locked.

CAUTION

- Even if the protect mode is set for certain files, they will be deleted if the card is reformatted.

HINT

To select a different image in step 3...

- Press [**◀**] or [**▶**].

To cancel the protect mode for a file...

- Display the desired file and repeat steps **1** to **4**. The protect mark  will disappear and the protect mode is canceled.

Protect selected files

Select multiple files to protect.

1 Display the **NORMAL Mode Playback Menu** (page 37).

2 Select **“PROTECT”** and press the **SET** button.

3 Select **“PROTECT SELECTED”** and press the **SET** button.

- Use the arrow keys to move the orange frame to the file you wish to protect.

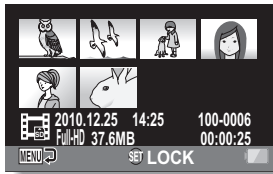

4 Press the **SET** button.

- The selected file is marked with the protect icon [].
- To cancel a protect selection and remove the protect icon from a file, move the orange frame to the marked file and press the SET button.

Resize

A captured image can be resized to a smaller size and saved as a separate image.

HINT

Why can't the image be resized?

- An image can be resized only to a smaller (or the same) size, not to a larger size.

Rotate

Captured still images can be rotated to the correct orientation for viewing.

HINT

- An image for which the protect mode has been enabled cannot be rotated. To rotate a protected image, cancel the protect mode before beginning the rotate image procedure (pages 51 and 100).

PLAYBACK MENU 2

Correcting the image

Repair the red-eye effect in still images to make the eyes appear more natural, or enhance the contrast.

HINT

If the “Contrast correction not successful” or “Red-eye correction not successful” message appears...

- The camera was not able to successfully repair the image.
- The correction function works to automatically edit flaws that the camera detects in captured images. In some cases, the camera may fail to correct a flaw.

Concerning the date and time information for the saved image

- When an image is corrected and saved, the recorded date and time of capture (Exif information) remains unchanged from the original image. However, the file date shown on the computer changes to the date and time the image was revised.

Editing video clips

You can trim away unwanted portions from a video clip and save it as a new video clip (video clip cutting [extracting]). You can also join video clips together and save them as one separate clip ("joining").

Procedure to cut (extract) a portion of a video clip

Specify the frames (①, ②) where the video clip is to be cut.

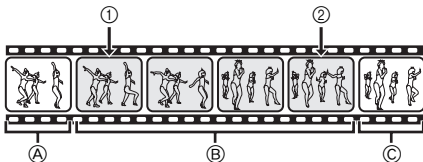

Extract the specified portion.

[Two ways to cut the video clip]

- Trim away portions ① and ②, and save portion ③.



- Delete portion ②, and join portions ① and ③.



- The original video clip is not affected.



(You can also choose to erase the original video clip when the new clip is saved.)

Procedure to join video clips

Specify the video clip that will come first.



Specify the video clip that you wish to append (join).



Join the video clips.

- The video clips are joined.

••



- The original video clips are not affected.
(You can also choose to erase the original video clips when the new clip is saved.)

•••••



CAUTION

Caution when editing video clips

- When editing video clips, do not turn off the camera, as doing so may erase the original video clip.
- As the number or size of the video clips increases, the card memory may become full, making it impossible to edit or save the video clips. In this case, you will need to free some of the memory on the card by deleting files that are no longer necessary (pages 51 and 76).

Regarding the capture date of the saved files

- The capture date of edited images changes to the date that the files are saved.

Video clip cutting (extracting)

1 Display the video clip from which you wish to extract a segment.

2 Display the NORMAL Mode Playback Menu (page 37), select “EDIT VIDEO”, and press the SET button.



3 Select “CUT” and press the SET button.

- The Cutting Screen appears.

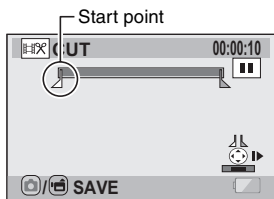

4 Specify the start point of the extract.

- Use the procedure below to specify the frame from which the video clip extract will start.
- Play the video clip until approximately the desired point, pause the video clip, then play the video clip one frame at a time, stopping at the start point of the extract. This will be the first frame of the extract.
- If the start point of the video clip is also the start point of the extract, proceed to step 5.

<Procedure>

Play:

After pausing playback, press and hold [▶] for about 2 seconds for forward playback, or [◀] for reverse playback.

Pause:

During playback, press the SET button.

Accelerated playback:

During playback, press [◀] or [▶] to change the playback speed.

Single frame:

After pausing playback, press [▶] to move forward one frame, or [◀] to move back one frame.

5 Press [▲].

- The start point of the video clip extract is set, and the screen to specify the end point appears.
- Specify the end point of the extract by following the same procedure as in step 4.

<When joining the first and latter portions>

- ① Press [▼].
 - Each time [▼] is pressed, the sections to delete and the sections to save are reversed.
- ② Specify the end point of the extract. The frame following the end point of the extract will be the start point of the latter portion to be joined.

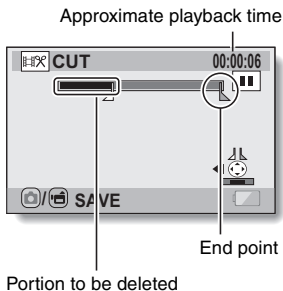

6 Press the [] or [] button.

- A screen appears for you to select either to save the edited video clip as a new (separate) file, or to delete the original video clip and replace it with the edited video clip.

SAVE AS NEW:

The edited video clip will be saved as a new file. The original video clip remains unchanged.

OVERWRITE:

The original video clip will be deleted. Only the edited video clip will be saved.

REVIEW CLIP:

Play back the edited video clip before saving it.

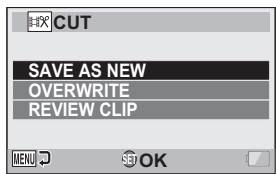

7 Select the desired option, and press the SET button.

- Editing starts.
- When editing ends, you are returned to the NORMAL Mode Playback Menu.

HINT

- You will not be able to overwrite the file if the original file is protected.
- If the “Insufficient card memory” or “Insufficient internal memory” message appears, you will need to free some of the memory by deleting files that you do not need to keep.

CAUTION

Warning concerning the battery pack remaining charge

- During the editing of lengthy video clips, the time to process the large amount of data can become quite long. To avoid problems caused by the battery pack becoming depleted in the middle of video clip editing, before starting to edit be sure that a sufficiently charged battery pack is installed in the camera, or connect the AC adaptor.
- It is recommended that a computer be used to edit long video clips.

Joining video clips

CAUTION

- Video clips that were photographed in different modes cannot be joined.

- 1** Display the **NORMAL Mode Playback Menu (page 37)**, select **“EDIT VIDEO”**, and press the **SET** button.

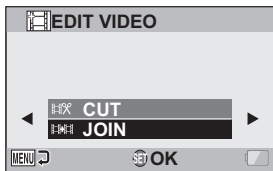

- 2** Select **“JOIN”** and press the **SET** button.

- The 8-image playback display for video clips appears.

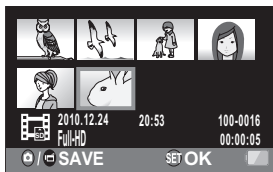

- 3** Move the orange frame to the video clip you wish to join, and press the **SET** button.

- The specified video clip is labeled with a number.
- Up to 9 video clips can be selected.
- To cancel a selection and remove the number label from a video clip, select the video clip and press the **SET** button.

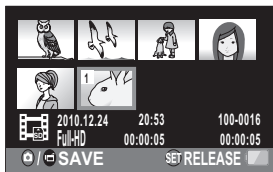

4 Press the [] or [] button.

- A screen appears for you to select either to save the joined video clip as a new (separate) file, or to delete the original video clips and replace them with the joined video clip.

SAVE AS NEW:

The joined video clip will be saved as a new file. The original video clips remain unchanged.

OVERWRITE:

The original video clips will be deleted. Only the joined video clip will be saved.

REVIEW CLIP:

Play back the joined video clip before saving it.

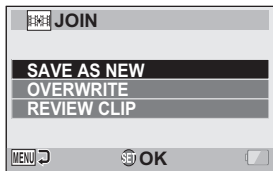

5 Select the desired option, and press the SET button.

- Editing starts.
- When editing ends, you are returned to the NORMAL Mode Playback Menu.

HINT

- If the file size of the video clip after editing exceeds 4 GB, it is not possible to either "SAVE AS NEW" or "OVERWRITE".
- You will not be able to overwrite the file if the original file is protected. If you want it to be erased, you will need to first remove the protection (pages 51 and 100).
- If the "Insufficient card memory" or "Insufficient internal memory" message appears, you will need to free some of the memory by deleting files that you do not need to keep.

CAUTION**Warning concerning the battery pack remaining charge**

- During the editing of lengthy video clips, the time to process the large amount of data can become quite long. To avoid problems caused by the battery pack becoming depleted in the middle of video clip editing, before starting to edit be sure that a sufficiently charged battery pack is installed in the camera, or connect the AC adaptor.
- It is recommended that a computer be used to edit long video clips.

Printing instructions

In addition to using your printer to print out still images captured with your camera, as with conventional film, you can have prints made at shops offering digital print services. Moreover, this camera is DPOF-compatible, so you can use the camera to specify the number of prints, whether or not the date is displayed on the print, and also to request an index print.

Display the Printing Instructions Screen

1 Select a photo from the Playback Screen.

- A photo must be selected in order to access the Print Instructions Screen.

2 Display the NORMAL Mode Playback Menu (page 37), select "PRINT INSTRUCTIONS", and press the SET button.

ALL IMAGES:

The specified printing instructions apply to all the images.

EACH IMAGE:

The printing instructions are specified for each individual image.

INDEX:

All the still images are printed as miniature images (thumbnail images), several images on one print.

ALL CLEAR:

Clear all the printing instructions. This cannot be selected if no printing instructions have been specified for an image.

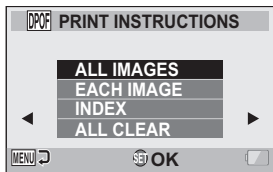

HINT**Printing a single frame from a video clip**

- To print with a printer or have the digital print service shop print out a still image from a video clip, you must first save it (extract still) as a still image (page 73).

About the DPOF format

- DPOF (Digital Print Order Format) is a print order format. You can connect your camera to a DPOF-compatible printer to produce your prints. You can also set the printing instructions for the desired images, and then have the requested images printed automatically (page 143).

About the finished prints

- Rotated images (pages 51 and 102) will be printed in their original orientation.
- The quality of the print output will differ depending on the print service and printer used.

Specifying date imprinting and print quantities

You can specify printing instructions for each individual image (EACH IMAGE), or apply the printing instructions to all the images (ALL IMAGES).

1 Display the Printing Instructions Screen (page 113).**2 Select “ALL IMAGES” or “EACH IMAGE”.****ALL IMAGES:**

The printing instructions are applied to all the images.

EACH IMAGE:

The printing instructions are applied only to the image currently displayed.

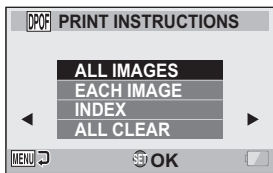

3 Press the SET button.

- The Date/Copies Print Screen appears.
- If "EACH IMAGE" was selected, press [◀] or [▶] to display the desired image to print.
- The printing instructions that are currently active for the displayed image are shown. You can press [◀] or [▶] to confirm the printing instructions for each image.

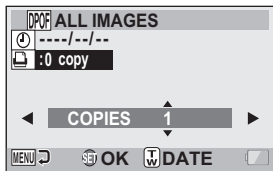

Printing instructions

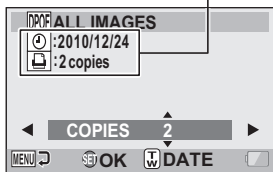

<Completed printing instructions>

4 Specify whether the date is displayed on the print, and the number of prints.

<Specify the number of prints>

- Press [▲] or [▼].
 - The quantity indication changes.
 - Display the desired number of prints.
- Press the SET button.
 - The number of prints is set.

<Specify dated prints>

- From the screen on which the number of prints is set, press the zoom switch.
- Press the SET button.

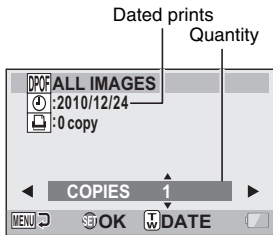

5 Press the MENU button.

- The printing instructions for the requested print quantities and dated prints are stored.
- The display returns to the Printing Instructions Screen.

HINT

Can't specify dated prints?

- Dated prints are not possible for photos that were captured before the camera's date and time setting was completed.

Index print

Printing out many small images on one sheet is called an "index print". This is convenient for use as a list of the images you have captured.

FILE INFO DISPLAY

On the Information Screen you can check what the settings were when a file was recorded with your camera.

1 Display the desired file on the camera monitor.

2 Press the MENU button for at least 1 second.

- The Information Screen appears.
- If the MENU button is pressed again, the Information Screen is canceled.

- 1 Video clip mode settings
- 2 Image or sound number
- 3 Protect setting
- 4 File size
- 5 Shooting or recording time
- 6 Exposure compensation setting
- 7 Aperture value
- 8 Shutter speed
- 9 Remaining battery charge
- 10 Date and time of image
- 11 Still image mode settings
- 12 ISO sensitivity setting

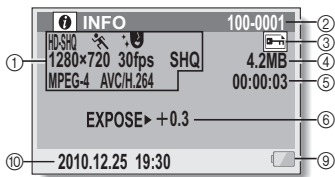

<Video clip file>

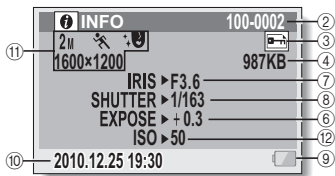

<Still image file>

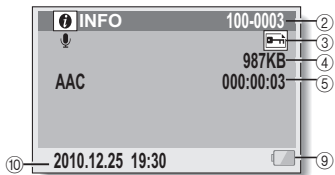

<Audio file>

DISPLAY THE OPTION SETTING MENU

The camera settings are executed via the Option Setting Menu.

- 1 Turn on the camera, set it to the NORMAL mode, and press the MENU button.



Option tab

- 2 Select an Option tab (1, 2 or 3), and press the SET button.
 - The Option Setting Menu appears.
 - If you press [▶], the screen to select a setting to change appears.

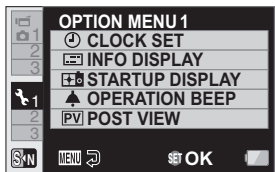

To access a Setting Screen

- 3 Press [▲] or [▼] to select the item you wish to set, and press the SET button.
 - The Setting Screen for the selected item appears.
 - To return to the Menu Screen, press the MENU button.

INTRODUCTION TO THE OPTION SETTING MENU

Tab 1

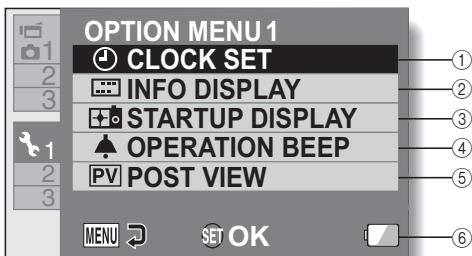

① CLOCK SET setting (page 33)

- Set the camera's clock.

② INFO DISPLAY setting

- Specify the information to display on the playback screen.

SHOW ALL:

Display the capture date and playback time (video clips).

DATE & TIME:

Display the capture date.

COUNTER:

Display the playback time when playing back a video clip.

OFF:

Do not display the capture date or playback time.

③ STARTUP DISPLAY setting

- Select the display that appears on the monitor when the camera is turned on in the recording mode.

④ OPERATION BEEP setting

- Settings for the camera's operation sounds, audio guide and volume.

TURN ON/OFF:

Mute or enable the sounds when the camera is turned on or off.

SHUTTER:

Select the sound that is produced when the [] button is pressed.

KEY SW:

Select the sound that is produced when the SET button, MENU button, etc. are pressed.

AUDIO GUIDE:

Mute or enable the camera's audio help guide.

OPERATION VOL:

Adjust the volume of the operation sounds.

⑤ POST VIEW setting

- Specify the duration that the captured image is shown on the monitor (post-view) after the [] button is pressed.

⑥ Remaining battery charge display (page 137)

Tab 2

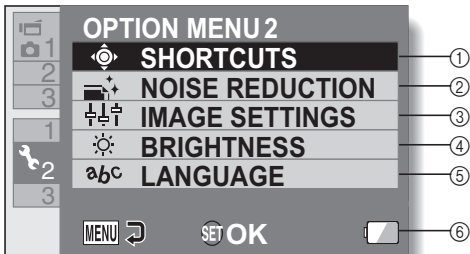

- ① **SHORTCUTS setting**
(page 125)
- ② **NOISE REDUCTION setting**
 - Compared to normal shooting, when the PHOTO NR function is ON, the image processing time after shooting a still image is slightly longer.

VIDEO NR:
Turn ON/OFF the image noise reduction function during video clip recording.

PHOTO NR:
Turn ON/OFF the image noise reduction function during still image shooting.

WIND SOUND NR:
Turn ON/OFF the wind noise reduction function during video clip/audio shooting.
- ③ **Image quality setting**
 - Set the vividness and sharpness of the images.
- ④ **BRIGHTNESS setting**
 - Adjust the brightness of the camera's monitor display.
- ⑤ **LANGUAGE setting**
 - Select the language in which the monitor messages are displayed.
- ⑥ **Remaining battery charge display** (page 137)

Tab 3

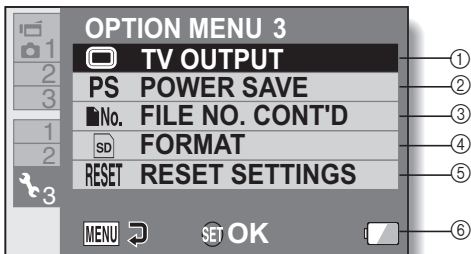

- ① **TV OUTPUT setting (page 128)**
- ② **POWER SAVE setting (page 31)**
 - Specify the elapsed period of inactivity before the power save mode (to conserve battery power) is activated.
- ③ **FILE NO. CONT'D setting (page 132)**
- ④ **FORMAT (page 134)**
- ⑤ **RESET SETTINGS**
 - Reset the camera settings to the factory-preset settings.
 - The following settings do not change with this procedure:
 - Date and time setting
 - TV system setting
 - Language setting
- ⑥ **Remaining battery charge display (page 137)**

Shortcut setting

Assign functions (operation shortcuts) to the arrow keys when they are pressed while the Recording Screen is displayed.

1 Select "SHORTCUTS", and press the SET button.

- : Assign the function when [▲] is pressed.
- : Assign the function when [▼] is pressed.
- : Assign the function when [◀] is pressed.
- : Assign the function when [▶] is pressed.

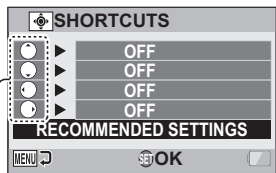

Arrow keys

RECOMMENDED SETTINGS:

The most commonly used settings are automatically assigned.

2 Select the arrow key to which you wish to assign the function, and press the SET button.

- The screen to assign a function to the key appears.

OFF: No operation shortcut is assigned to the key.

AF LOCK: Lock the focus (page 61).

AE LOCK: Lock the exposure setting (page 61).

FOCUS: Set the focus range (pages 57 and 89). (This operation shortcut can be assigned only to the or key.)

FLASH: Set the flash operation (pages 42 and 63).

EXP COMPENSATION: Adjust the exposure (page 97).

ISO: Set the ISO sensitivity (pages 48 and 91).

SEQUENTIAL: Switch between sequential shots and single shots.

SELF-TIMER: Set the self-timer (pages 46 and 87).

EXPOSURE: Set the exposure value for the exposure setting (pages 50 and 93).

DISP. ON/OFF: Turn the shooting settings display on/off.

-  **PHOTO VIEW:** Select the desired field of view (photo view or video view) for the Recording Standby Screen display. When “photo view” is selected, a frame to show the field of view during video clip recording appears.

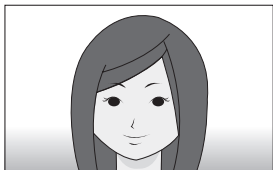

<Video view>

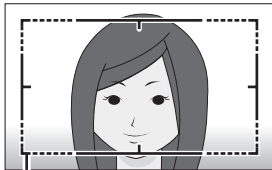

Video clip recording area

<Photo view>

3 Press [▲] or [▼].

- Display the function you wish to assign to the key.

4 Press the SET button.

- The selected function is assigned to the key, and you are returned to the Shortcuts Screen.
- To assign functions to the other keys, repeat steps 2 through 4.

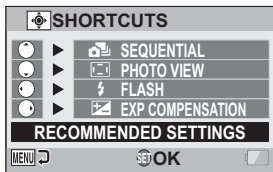

<When “RECOMMENDED SETTINGS” is selected>

5 Press the MENU button.

- The screen to confirm the shortcut settings appears, and then you are returned to the Option Setting Menu.
- This completes the shortcuts setting.

<To confirm the assigned shortcuts>

- On the screen in step 1, press the MENU button, and the screen to confirm the shortcut settings appears.

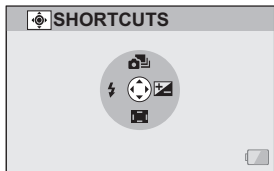

TV output setting

Specify the type of image signal that is output from your camera's USB AV terminal.

- 1** Select "TV OUTPUT", and press the SET button.

TV SYSTEM:

Set the type of TV signal that is output from the USB AV terminal.

TV TYPE:

Set the TV's aspect ratio.

HDMI:

Set the signal that is output from the HDMI terminal.

HDMI-CEC:

Set the HDMI-CEC function.

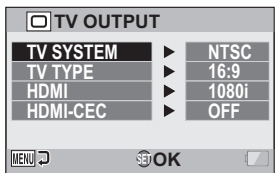

- 2** Select the desired setting, and press the SET button.

- The screen to change the parameter for the selected setting appears.

<If "TV SYSTEM" is selected>

NTSC: Outputs NTSC video signals.

PAL: Outputs PAL video signals.

<If "TV TYPE" is selected>

16:9: Use this setting when a TV having an aspect ratio of 16:9 is connected.

4:3: Use this setting when a TV having an aspect ratio of 4:3 is connected.

<If "HDMI" is selected>

AUTO: The camera automatically determines the appropriate setting.

720p: Choose this setting if the video clip was recorded in the **[HD-SHQ]** or **[HD-HR]** mode.

1080i: Choose this setting if the video clip was recorded in the **[Full-HD]** or **[Full-SHQ]** mode.

480p: Choose this setting if the video clip was recorded in the **[TV-SHQ]** mode.

- Does not work with 480i connector.

<If "HDMI-CEC" is selected>

ON: Sets the HDMI-CEC function to "ON".

OFF: Sets the HDMI-CEC function to "OFF".

3 Press [▲] or [▼] to select the desired parameter.

4 Press the SET button.

5 Press the MENU button.

- This completes the TV output setting.



HINT



About the HDMI-CEC function

- This is a system control function by which, through an HDMI cable, a control signal is output to electronic devices and the operation of multiple devices is coordinated.
- The HDMI-CEC function will operate correctly only when the camera is connected to a SANYO TV that incorporates the HDMI-CEC function.
- When the HDMI-CEC function is used, your TV's remote control unit can be used to operate the camera playback; however, it does not work to turn the camera ON. In addition, in the playback mode, the camera's power save function is disabled.
- For information concerning connecting and operation, please see your TV's instruction manual.
(As of May 2008, SANYO TVs that incorporate the HDMI-CEC function have not been released.)

Relation between “TV TYPE” setting and TV display

The tables below show the video signal that is output when the “TV TYPE” setting is changed. However, note that for some TVs that have an auto-detect function, the output may not conform to the table, or the TV display may not change at all.

“TVTYPE” setting	TV type to be connected	Image file to be displayed	TV display
4:3	4:3	Still image (4:3)	
		Video clip in SD mode	
		Video clip in HD mode	

"TVTYPE" setting	TV type to be connected	Image file to be displayed	TV display
16:9	16:9	Still image (4:3)	
		Video clip in SD mode	
		Video clip in HD mode	

CAUTION

If the TV display is not correct...

- If the appearance of the image on the TV monitor is not correct, you can either change the camera's "TV TYPE" setting, or change the screen size setting on your TV. To change the screen size setting on your TV, please refer to the instruction manual for your TV.

The aspect ratio of the output still image does not change to 16:9?

- The still image output will be 4:3 for images captured in a 4:3 still image mode.

File No. continued setting

If a newly formatted card is used, the file name (image number) of the captured image automatically begins from 0001. If the card is subsequently reformatted, or if a different reformatted card is used, the file names again begin from 0001. This is because the file number continued function is set to "OFF", and consequently it results in more than one card containing images with the same numbers, or may result in unintentionally overwriting files when, for example, saving files in a computer. By setting the file number continued function to "ON", even if the card is reformatted or the card is replaced with another card, the consecutive numbering of file names continues from the last number recorded by the camera.

<File number continued function "OFF">

	File name (image number)
Card A	0001, 0002..... 0012, 0013

⋮
Replace card



Card B	0001, 0002..... 0012, 0013
--------	----------------------------

<File number continued function "ON">

	File name (image number)
Card A	0001, 0002..... 0012, 0013

⋮
Replace card



Card B	0014, 0015.....0025, 0026
--------	---------------------------

- If Card B already has files in it when it replaces Card A, file names are assigned as follows.

When the highest file number on Card B (before replacing) is lower than the highest file number on Card A: the file name of the next recorded image continues from last file name recorded on Card A.

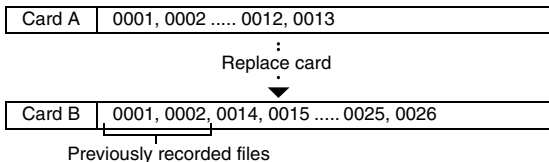

When the highest file number on Card B (before replacing) is higher than the highest file number on Card A: the file name of the next recorded image continues from last file name recorded on Card B.



HINT

- Until the file number continued function is turned “OFF”, consecutive file names are assigned. It is recommended that the file number continued function be returned to “OFF” at the end of each photography session.

Formatting (initializing)

A card must be formatted with this camera:

- After purchasing, when used for the first time, or
- If it was formatted using a personal computer or another digital camera.

The card cannot be formatted if the lock switch is set to the “LOCK” position. Proceed with the format procedure after setting the lock switch to the unlocked position.

CAUTION

Caution during formatting

- Do not turn off the power to the camera or eject the card during formatting.

Formatting erases the data

- When a storage medium is formatted, all recorded files on the medium are erased. Protected data (pages 51 and 100) is also erased, so before formatting a card, any data you want to keep should be copied to your personal computer's hard disk or other storage medium.

Caution regarding disposing/transferring the card (recovering data from a reformatted card)

- If a card is reformatted or the data is erased from the card using the camera or a computer, the card's control data may be merely modified and the data itself may not be completely erased from the card.
- In some cases it may be possible to recover the data from a reformatted card using special software for that purpose.
- If you are disposing of a card, it is recommended that you physically destroy it. If you are transferring the card to someone else to use, it is recommended that you use commercially available software for erasing card data. Managing data is the responsibility of the user.

CHECKING THE REMAINING CARD MEMORY

You can check how many images can be captured and how much recording time is available on the card. For a table showing the maximum number of images and recording time for specific cards, please see “Possible No. of Images/Possible Shooting Time/Possible Recording Time” on page 168.

Checking the remaining number of images and video recording time

1 Set the camera to the recording mode (page 35).

- The remaining number of images appears in the upper left of the monitor.
- The remaining video recording time appears in the upper right of the monitor.
- The remaining number of images and video recording time will differ depending on the resolution and compression settings.

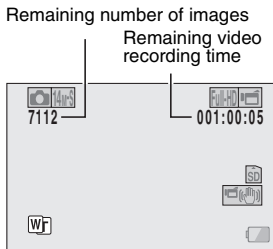

For audio recordings

- 1 Set the camera to the audio recording mode (page 82).**
 - The remaining audio recording time is shown.

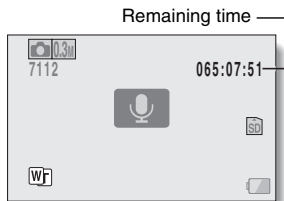

HINT

- When the remaining number of images or the remaining video recording time is “0”, you cannot capture any more images. To capture more images, either install a new card, or save the images to a computer and then delete them (page 76) from the card.
- When the remaining number of images or the remaining video recording time is “0”, it may be possible to capture a few more images by setting a lower resolution setting (pages 56, 82 and 85), or selecting a different image quality setting.

CHECKING THE REMAINING BATTERY PACK CHARGE

When using the battery pack, the remaining battery pack charge can be checked on the monitor. Make sure to check this indicator before capturing an image. For an indication of the possible length of time for battery pack operation, see page 167.







1 Display the Recording Menu or Playback Menu (page 37).

- The battery pack remaining charge indicator appears in the lower right corner of the monitor.
- Due to the battery pack characteristics, when the ambient temperature is low,  may appear early for an incorrect indication of the remaining charge.

Also, depending on the conditions of use of the camera or the ambient conditions (temperature, etc.), the indicated remaining charge may change. Therefore, this indication can only be used as a general approximation of the remaining charge.



Battery pack remaining charge indicator

Battery pack remaining charge indicator	Battery remaining charge
	Approx. full.
	Power is low.
	It will soon be impossible to capture or play back images.
	If this icon flashes when the [] button or [] button is pressed, images cannot be captured. Recharge the battery pack.

HINT

- If any file is present, you can also check the remaining battery pack charge on the Information Screen (page 117).
- Battery life may differ even among battery packs of the same type.
- Depending on the usage of the camera (such as the number of times the flash is used, the use of the monitor, etc.) or the ambient temperature (temperatures below 10 °C [50 °F]), the number of images that can be saved on a fully charged battery pack will vary greatly.
- It is recommended that you prepare an extra battery pack(s) when taking pictures at a wedding or while traveling, for example, so you don't miss capturing images of important moments due to the battery pack power running out. The same is recommended for taking photos in cold environments. (In a ski area, for example, the battery pack can be kept warm in your pocket until ready to use.)

CONNECTING TO A TV

By connecting the camera to a TV, you can play back the recorded files on the TV.

CAUTION

Insert and pull out the cable carefully

- When connecting the cables, make sure that the cable plugs are correctly oriented and that they match the shapes of the terminal sockets on the devices. Push the plugs in straight when connecting them. If undue force is used to connect a cable, it may permanently damage the connector pins in the terminal socket.
- Do not use excessive force when connecting and disconnecting cables.

About image output: The image output destination differs depending on the camera status.

Connection cable	Image output destination	Recording mode		Playback mode
		Standby	Recording	
Dedicated AV interface cable	Camera monitor	NTSC: × PAL: ○	○	×
	TV	NTSC: ○ PAL: ×	×	○
HDMI cable	Camera monitor	×	○	×
	TV	○	×	○

○: Images are output ×: Images are not output

HINT

- HDMI, the HDMI logo and High-Definition Multimedia Interface are trademarks or registered trademarks of HDMI Licensing, LLC.



Connecting to a video input terminal

Use the supplied dedicated AV interface cable to connect to a TV.

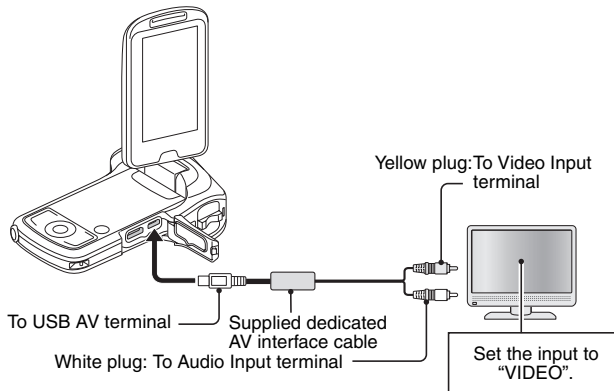

Connecting to the HDMI terminal

Use a separately sold mini-HDMI cable to connect to a TV.

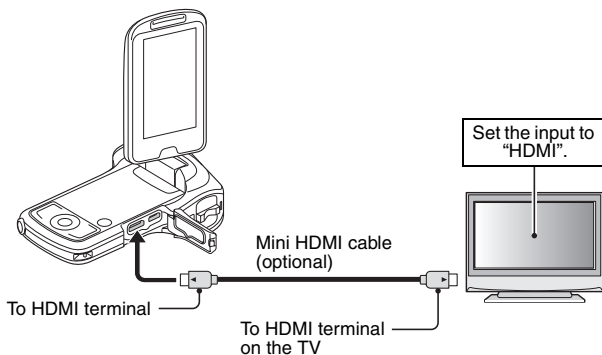

PLAYING BACK ON A TV

- After connecting the camera to the television, switch the TV input to the terminal to which the camera is connected.
- The playback method is the same as when viewing images on the camera's monitor. (Use the TV controls to adjust the volume.)
- The same playback procedure as when playing back with the camera is used to play back audio recordings as well.
- The audio playback is monaural.

CAUTION

Insert and pull out the cable carefully

- When connecting the cables, make sure that the cable plugs are correctly oriented and that they match the shapes of the terminal sockets on the devices. Push the plugs in straight when connecting them. If undue force is used to connect a cable, it may permanently damage the connector pins in the terminal socket.
- Do not use excessive force when connecting and disconnecting cables.

Copying (dubbing) images to a DVD recorder

- Please refer to the section on "Dubbing" in the instruction manual for your DVD recorder.

PRINTING

Your camera supports the PictBridge function. By connecting the camera directly to a PictBridge-enabled printer, the camera's monitor can be used to select images and initiate printing (PictBridge printing).

- 1** Open the monitor unit to turn on the camera, and turn on the printer.
- 2** Use the supplied dedicated USB interface cable to connect the camera to the printer.

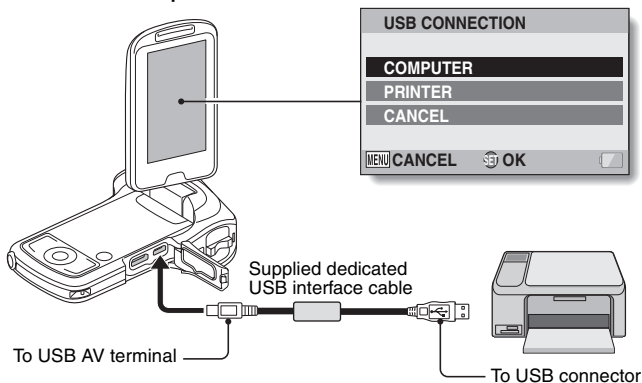

3 Select “PRINTER”, and press the SET button.

4 The PictBridge printing mode is activated.

- The camera switches to the PictBridge printing mode, and the PictBridge Menu Screen appears.



5 Select the desired type of printing, and press the SET button.

PRINT 1 IMAGE: Select the still images you wish to print.

PRINT ALL IMAGES: Print all the still images.

INDEX: Print all the still images as thumbnail images, many images per print.

DPOF: Print images according to the printing instruction settings.

PRINTER SETTINGS: Print images according to settings specified by the camera, such as paper size, type, size, layout, printing quality, etc.

HINT**To cancel printing**

- ① **During printing, press [▼].**
 - The confirmation screen to cancel printing appears.
- ② **Select “CANCEL” and press the SET button.**
 - If “EXIT” is selected and the SET button is pressed, printing resumes.

About printing all the images

- Printing is not possible if there are more than 999 images in the memory.
- Delete unwanted images before printing.

About DPOF printing

- DPOF printing is not possible if your printer is not DPOF-compatible.

About the printer settings

- The printer setting parameters shown on the Printer Settings Screen will differ depending on the printer that is connected.
- To use printer values that do not appear on your camera's Printer Settings Screen, select “[

CAUTION

Insert and pull out the cable carefully

- When connecting the cables, make sure that the cable plugs are correctly oriented and that they match the shapes of the terminal sockets on the devices. Push the plugs in straight when connecting them. If undue force is used to connect a cable, it may permanently damage the connector pins in the terminal socket.
- Do not use excessive force when connecting and disconnecting cables.

Caution when connecting a printer

- If the power to the printer is turned off while it is connected, the camera may not operate correctly. If the camera does not operate correctly, disconnect the USB interface cable, turn off the camera, and then reconnect the cable.
- During PictBridge printing, the camera's button operation response is slower.
- If the camera is powered by the battery pack for printing, make sure that the remaining battery charge is sufficient.



COMMONLY ASKED QUESTIONS

If you have a question about the camera operation, you might find the answer in this compilation of commonly asked questions.

	Question	Answer	Action
Power	Why doesn't the power turn on?	Due to cold temperatures, the battery pack temporarily lost its power.	Place the camera in your pocket to warm it up before using it.
	Why is the battery pack consumed so quickly even after it was fully recharged?	The ambient temperature is very low.	Keep the battery pack in an environment of 10 to 40 °C (50 to 104 °F).
		The battery pack life has expired.	If a battery becomes depleted quickly even after it was sufficiently charged, it should be assumed that the battery has reached the end of its service life. Please replace it with a new battery.
	Why doesn't recharging end?	The battery pack life has expired.	Replace with a new battery pack. If this is not effective, consult your dealer.
Why does the  icon appear?	The remaining battery pack power is low.	Use the AC adaptor, or replace the battery pack with a fully charged one.	
Shooting	Why does the multi-indicator flash red?	A recorded file is being saved on the card or internal memory.	Not a malfunction. Wait until the multi-indicator turns off.
	Why doesn't the flash operate?	The camera has determined that the image is bright enough and the flash is not necessary.	Not a malfunction. Capture the image; the camera will determine when the flash is necessary.

	Question	Answer	Action
Shooting	Are the settings retained even after the camera is turned off?	—	All settings except the self-timer and the exposure compensation are retained even after the camera is turned off.
	Which resolution setting should I use?	—	Select the resolution setting according to the intended use. 16M , 12M , 14M-H , 14M-S , 10M , 14MP : Appropriate for printing letter-size or larger, and for printing a close-up of part of a photo (trimming). 2M , 2M , 2MP : For printing standard photo (photo service) sizes. 0.9M , 0.3M : For photos displayed on a web page, or sent as e-mail attachments.

	Question	Answer	Action
Shooting	What is the difference between the digital zoom and the optical zoom?	—	Because shooting with the optical zoom uses the optics of a physical lens, you can shoot without losing minute details in the image. The digital zoom, on the other hand, works by magnifying a portion of the image that hits the image sensor and may produce a coarser image.
	How can I get the distant view into focus?	—	Set the scene select function to the landscape  mode when photographing. Or, set the focus range setting to manual focus [MF] , and set the distance to ∞.
	The video clip appears to freeze for an instant.	The ZOOM RANGE button was pressed during video clip recording.	Not a malfunction. During the very brief span that the zoom lens is changing, the recording appears as a still image.
	The zoom range does not change when the ZOOM RANGE button is pressed.	The ZOOM RANGE button was pressed while the digital zoom was engaged.	Not a malfunction. Use the optical zoom. The zoom range cannot be changed while the digital zoom is engaged.

	Question	Answer	Action
Monitor	When used in cold weather, why does the image seem to leave traces as it moves?	Condition due to the monitor characteristics.	Not a malfunction. Spots that appear in the monitor only appear in the monitor and will not be recorded with the images.
	Why does the displayed image contain some red, blue and green dots, or why are black spots visible?		
Viewing images	Why is the image too bright?	The subject was too bright.	When capturing an image, devise a way to compensate for a bright subject, for example, by changing the shooting angle.
	Why is the image out of focus?	The focus is not locked properly.	Hold the camera correctly and slowly press the [] button halfway to lock the focus. Then press the [] button all the way to capture the image.

	Question	Answer	Action
Viewing images	Why is there no image (□) is shown)?	This may happen when trying to play back images stored on a card from a different digital camera.	Play back images that were recorded on a card using this camera.
	Why is the playback image distorted?	If the subject moves or the camera is moved during recording, a distorted image may sometimes occur.	Not a malfunction. This is a characteristic of the CMOS sensor.

	Question	Answer	Action
Viewing images	Why isn't the magnified image clear?	Due to the characteristics of the camera, magnified images appear less clear.	Not a malfunction.
	Why isn't the captured image clear?	The image was captured using the digital zoom.	Not a malfunction.
	Can I play back image and sound files that I edited using my computer?	—	We cannot guarantee the accurate playback of files that have been edited using a computer.
	Why is there a motor-like sound during video clip playback?	The sound of the camera's mechanical action was recorded.	Not a malfunction.
Connecting to a TV	Why is there no sound?	The volume on the TV is set to the minimum.	Adjust the volume on the TV.
Printing	Why does a message appear during PictBridge printing?	There is a problem with the printer.	Please refer to the instruction manual for your printer.

	Question	Answer	Action
Misc.	The "Cannot edit video clips with unlike settings" message appears.	You have attempted to join video clips having different resolutions or frame rates.	Select video clips that have the same resolution or frame rate.
	Why is a noise heard from a nearby TV or radio during battery recharging?	Electromagnetic waves are emitted from the charger.	Move the AC adaptor further away from the TV or radio when recharging the battery pack.
	Why does the "Insufficient card memory" or "Insufficient internal memory" message appear?	There is no more available memory on the card or in the camera's internal memory.	Delete unnecessary files, or use a card that has more memory available.
	Why does the "Card is protected" message appear?	The lock switch on the card is in the locked (protect) position.	Move the lock switch to the unlocked position.
	Why can't the camera be operated?	A temporary internal circuitry problem may be the cause.	Remove the AC adaptor and the battery pack from the camera, wait a few minutes, then reinstall the battery pack and try again.
	A problem such as inability to record or play back occurs.	The card contains files that were saved using a device other than this camera.	After saving your files to a different medium, format the card.



	Question	Answer	Action
Misc.	Can I use my camera abroad?	—	When the camera is connected to a TV, you can switch the camera's video output to NTSC or PAL. If you have questions about accessories etc., please consult with a dealer near you for advice.
	Why does the "System error" message appear?	A problem has occurred within the camera or card.	Check the following items: ① Remove the card and then install it again. ② Remove the battery pack and then install it again. ③ Install a different card. If "System error" still appears after performing the above steps, then take the camera to the dealer for service.



TROUBLESHOOTING

Before taking your camera to the repair shop, check the following table for a possible solution to the problem.



Camera

	Problem	Cause	Action	Reference page
Power	No power.	The battery pack is dead.	Recharge the battery pack, or replace with a fully charged battery pack. Or connect the AC adaptor.	24
		The battery pack has not been inserted correctly.	Reinsert the battery pack, making sure to orient it correctly.	
	A blinking temperature warning icon is  shown, and the camera does not turn on.	The battery pack is too hot.	Wait for the battery pack to cool down.	29
	The camera turns off by itself.	The power save function is operating.	Turn on the camera again.	31

	Problem	Cause	Action	Reference page
Shooting	An image is not captured when the [] button or [] button is pressed.	The power is not turned on.	If the power save function was activated, turn on the camera before shooting. If the camera was turned off, press the ON/OFF button to turn it on.	30, 31
		The maximum number of images that can be captured or the maximum video clip recording time has been reached.	Install a new card.	22
			Delete the images that are not necessary.	76
	The flash does not operate.	The flash off mode is selected.	Set the flash to automatic flash mode or forced flash mode.	42, 46, 63
		The battery pack is dead.	Recharge the battery pack, or replace with a fully charged battery pack. Or connect the AC adaptor.	24

	Problem	Cause	Action	Reference page
Shooting	The digital zoom does not work.	The still image is set to  or  .	Set it to a different mode.	46, 85
		The digital zoom setting is set to "OFF".	Set the digital zoom setting to "ON".	50, 67
	A warning tone (beep-beep-beep) sounds, and it is not possible to take a picture using the self-timer.	The battery pack is consumed.	Recharge the battery pack, or replace with a fully charged battery pack. Or connect the AC adaptor.	24
	When zooming in or out, the zoom movement stops momentarily.	The optical zoom has moved to the maximum magnification position.	Not a malfunction. Release the zoom switch, and push it again.	67
	There is noise in the captured image.	The ISO sensitivity setting is too high.	Set the ISO sensitivity to a lower setting.	48, 91
	The  icon appears, and shooting is not possible.	The camera's internal temperature is high.	Discontinue shooting, and wait for the camera to cool down before using it again.	29

	Problem	Cause	Action	Reference page
Monitor	No playback image appears.	The camera is not set to the playback mode.	Set the camera to the playback mode.	35, 70
Viewing images	The image is too dark.	The flash was blocked by a finger or other object.	Hold the camera correctly, and make sure the flash is not obstructed.	53
		The subject was too far away.	Capture the image in the range of operation of the flash.	166
		The subject was lit from behind.	Use the forced flash mode.	42, 46, 63
			Use the exposure compensation function.	97
			Use the spot light-measuring mode.	48, 90
There is not enough light.	Adjust the ISO sensitivity setting.	48, 91		

	Problem	Cause	Action	Reference page	
Viewing images	The image is too bright.	The forced flash mode is selected.	Select a different flash mode.	42, 46, 63	
		The subject was too bright.	Use the exposure compensation function.	97	
		The ISO sensitivity setting is incorrect.	Set the ISO sensitivity to AUTO .	48, 91	
	The image is not in focus.	The subject is too close to the camera.	The focus setting is not correct.	Capture the image with the subject within the photographable range. Select the correct focus setting for your needs.	48, 57, 89
		The camera moved when the [] button was pressed. (camera shake)			
		The focus is not locked properly.	Hold the camera correctly and slowly press the [] button halfway to lock the focus. Then press the [] button all the way to capture the image.		53, 60
		The lens is dirty.			





























	Problem	Cause	Action	Reference page
Viewing images	The colors of the images captured indoors are not correct.	This is due to ambient lighting.	Capture the image using the forced flash mode.	42, 46, 63
		The white balance setting is incorrect.	Set the white balance setting correctly.	50, 92
	A part of the image is missing.	The strap or a finger was blocking the lens.	Hold the camera correctly, and make sure the lens is not obstructed.	53
	“No image” is shown.	There is no file in the internal memory or in the installed card.	Play back after capturing images or making audio recordings.	—
	During audio playback, there is no sound.	The playback volume setting on the camera is too low.	Adjust the playback volume.	51, 71, 75
Connecting to a TV	There is no color in the image. The image is distorted.	The TV output setting is not correct.	Select the correct TV output setting.	124, 128

	Problem	Cause	Action	Reference page
Connecting to a TV	No image or sound.	The camera is not correctly connected to the TV.	Follow the instructions to make the connection correctly.	139, 140
		The TV input setting is not correct.	Set the TV input to the correct setting.	
	The edge of the image is cut off.	This is a characteristic of the TV.	Not a malfunction.	—
Image editing	You cannot edit or rotate an image.	The protect mode is set.	Cancel the protect mode.	51, 100
Charging	The battery pack is not charging.	The battery pack is not correctly inserted in the charger.	Make sure that the battery pack is correctly oriented when inserting it in the charger.	24
Misc.	The "Image is protected" message appears and the file cannot be deleted.	You have attempted to delete a file that is protected from accidental erasure.	Set the protect setting for the file to UNLOCK.	51, 100

	Problem	Cause	Action	Reference page
Misc.	The audio guide does not sound.	The audio guide setting is set to "OFF".	Set the audio guide setting to "ON".	120
	The recording capacity is less than that indicated in the section "Possible No. of Images/ Possible Shooting Time/ Possible Recording Time" (page 168).	The recording capacity is less than the value specified for the card.	Depending on the card, the capacity may be less than the specified value. Please refer to the instructions that accompanied the card.	—
	The battery pack appears to be swollen.	Normal change occurring with battery use. Even with normal correct use of the lithium-ion battery, it has a tendency to swell as the number of charge and discharge cycles adds up and it gradually approaches the end of its service life.	Not a safety hazard. However, a battery that is difficult to insert because it has become swollen may then be impossible to extract from the battery compartment. In this case, please discontinue its use and replace it with a new battery.	—



Notes regarding the Scene Select feature and filters

Scene Select



Setting	Remarks
Sports 	Focus range: Fixed at  .
Portrait 	Exposure: Fixed at  .
Landscape 	Focus range: Fixed at  Chaser settings: Fixed at  Exposure: Fixed at  .
Night view portrait 	Focus range: Fixed at  Still image setting: When sequential shots is active, changes to  Exposure: Fixed at  .
Snow & beach 	Focus range: Fixed at  .
Underwater 	Exposure: Fixed at  .
Fireworks 	Focus range: Fixed at  Flash: Fixed at  ISO sensitivity: Fixed at  Photo stabilizer: Fixed at "OFF". Chaser settings: Fixed at  Still image setting: When sequential shots is active, changes to  Exposure: Fixed at  .
Lamp* 	Focus range: Fixed at  Flash: Fixed at  Still image NR: Fixed at "OFF". Still image setting: When sequential shots is active, changes to  ISO sensitivity: Fixed at  Photo stabilizer: Fixed at "OFF". Exposure: Fixed at  .

* In some cases, the shutter speed may decrease to 1/15 sec.

Filter

Setting	Remarks
Monochrome 	Still image mode: 16M and 12M cannot be selected. Color chaser settings: Fixed at OFF .
Sepia 	

About the scene select function and focus range settings

- The scene select function changes to **AUTO** when the focus range is set to  or **MF**.
- Even if you set the focus range to  or **MF**, it changes to  when the scene select function is set to any setting other than **AUTO**.



SPECIFICATIONS

Camera

Recorded image file format	<p>Still images: JPEG format (DCF, DPOF, Exif 2.2 compliant) Note: Designed mainly by the Japan Electronics and Information Technology Industries Association (JEITA), DCF (Design rule for Camera File system) is standard for digital still camera image files to provide interoperability between digital photography devices for the images stored on removable memory cards. However, it is not guaranteed that all devices will support the DCF standard.</p> <p>Video clips: Conforms to ISO-standard MPEG-4 AVC/H.264*</p> <p>Audio: MPEG-4 audio (AAC compression) 48 kHz sampling rate, 16-bit stereo format</p>
Data storage media	Internal memory: Approx. 50 MB SD Memory Card SDHC Memory Card (up to 32 GB) SDXC Memory Card (up to 64 GB)
Image sensor/ camera effective number of pixels	1/2.33-inch (1.1 cm) CMOS sensor Still images: Approx. 14.3 million pixels Videos (HD mode): Approx. 11.9 million pixels Videos (SD mode): Approx. 14.3 million pixels

* Video clip files recorded with models VPC-CA65 and VPC-CG65 are in the same H.264 format as this model. However, such files cannot be played back, since they are not compatible due to differences such as the data compression method.

Still image shooting mode (recording resolution)	<p>16M: 4640 × 3480 pixels (approx. 16 million pixels)</p> <p>12M: 4608 × 2592 pixels (approx. 12 million pixels, 16:9 aspect ratio)</p> <p>14M-H: 4352 × 3264 pixels (approx. 14 million pixels, low compression)</p> <p>14M-S: 4352 × 3264 pixels (approx. 14 million pixels, normal compression)</p> <p>10M: 4352 × 2448 pixels (approx. 10 million pixels, 16:9 aspect ratio)</p> <p>2M: 1920 × 1080 pixels (approx. 2 million pixels, 16:9 aspect ratio)</p> <p>2M: 1600 × 1200 pixels (approx. 2 million pixels)</p> <p>0.9M: 1280 × 720 pixels (approx. 900,000 pixels, 16:9 aspect ratio)</p> <p>0.3M: 640 × 480 pixels (approx. 300,000 pixels)</p> <p>14M-S: 4352 × 3264 pixels (approx. 14 million pixels, sequential shots)</p> <p>2M-S: 1600 × 1200 pixels (approx. 2 million pixels, sequential shots)</p>
Video clip recording mode (recording resolution)	<p>Full-HD: 1920 × 1080 pixels, 60 fields/s (60i)</p> <p>Full-SHD: 1920 × 1080 pixels, 30 fps (30p)</p> <p>HD-HR: 1280 × 720 pixels, 60 fps (60p)</p> <p>HD-SHD: 1280 × 720 pixels, 30 fps (30p)</p> <p>TV-SHD: 640 × 480 pixels, 30 fps (30p)</p> <ul style="list-style-type: none"> The 60 fps frame rate of this camera is 59.94 fps, and the 30 fps frame rate is 29.97 fps.
White balance	Full-auto TTL; manual setting available
Lens	<p>Focal length: $f = 6.8 \text{ mm to } 34.0 \text{ mm}$, Optical 5× zoom</p> <p>Open: $F = 3.5 \text{ (wide) to } 3.7 \text{ (tele)}$</p> <p>8 groups, 10 elements (including three with four aspheric surfaces)</p> <p>Galvanometer iris</p> <p>Internal ND filter</p> <p>35 mm film camera conversion</p> <p>Still image shooting: 38 mm to 190 mm (Optical zoom 5×)</p> <p>Video clip recording:</p> <ul style="list-style-type: none"> Double-range zoom W mode: $f = 40 \text{ mm to } 240 \text{ mm}$ (Advanced Zoom 6×) Double-range zoom T mode: $f = 80 \text{ mm to } 480 \text{ mm}$ (Advanced Zoom 6×)

Exposure control type	Programmable AE/Shutter speed priority AE/ Aperture priority AE/Manual exposure control Exposure compensation available (0 ±1.8 EV in 0.3 EV steps)
Light-measuring mode	Multi-section measuring, center-weighted measuring, spot measuring
Range	Normal mode: 50 cm (19.69 in.) to infinity Super macro mode: 1 cm (0.39 in.) to 80 cm (31.50 in.) (wide end only)
Digital zoom	For shooting: 1× to approx. 10× For playback: 1× to approx. 72.5× (varies with resolution)
Shutter speed	Still image shooting mode: 1/2 to 1/1,500 sec. (Approx. 1 sec. max. when scene select function is set to lamp ) (During flash: 1/30 to 1/1,500 sec.) Sequential shots mode: 1/30 to 1/1,500 sec. (no flash) Video clip recording mode: 1/30 to 1/10,000 sec. (1/15 sec. max. when scene select function is set to lamp  or the high sensitivity mode)
Sensitivity	Still image shooting (standard output sensitivity*)/ video clip recording mode: Auto (video clip recording: ISO 50 to 800; still image shooting: ISO 50 to 400)/ISO 50, ISO 100, ISO 200, ISO 400, ISO 800, and ISO 1600 (switchable from the Recording Menu) <ul style="list-style-type: none"> • Sensitivity measured in compliance with the ISO standard (ISO 12232:2006). • Maximum ISO sensitivity up to 1600 equivalent when Scene Select function is set to .
Minimum subject illumination	17 lux (1/30 sec. in the scene select AUTO mode) 5 lux (1/15 sec. in the HIGH SENSITIVITY or lamp mode)
Image stabilizer	Video: Electronic Still image: Multi-calculation electronic
Monitor	2.7" (6.9 cm) low-temperature polysilicon TFT color wide liquid crystal (transmissive), approx. 230,000 dots

Flash working range	GN = 4.0 Approx. 50 cm (19.69 in.) to 2.3 m (7.55 ft.) (wide) Approx. 80 cm (31.50 in.) to 2.2 m (7.22 ft.) (tele)	
Flash modes	Auto-flash, forced flash, flash off	
Focus	TTL-type AF (still image shooting mode: 9-point range finder/spot focus; video clip recording mode: Continuous focus), manual focus	
Self-timer	Approx. 2-second delay, 10-second delay	
Ambient environment	Temperature	0 to 40 °C (32 to 104°F) (operation) -20 to 60 °C (-4 to 140°F) (storage)
	Humidity	30 to 90% (operating, no condensation) 10 to 90% (storage, no condensation)
Water-resistant	Compliant with JIS protection grade 8 standards (according to tests conducted in-house by Sanyo) Can be submerged at a maximum depth of 3.0 m (9.84 ft.), for up to 60 minutes.	
Power supply	Battery pack	Li-ion battery pack (DB-L80) ×1
	AC adaptor (supplied)	VAR-G12
Power consumption	3.5 W (When using the Li-ion battery during recording)	
Dimensions (excluding protrusions)	92.0 (W) × 40.8 (D) × 123.0 (H) mm 3.62 (W) × 1.61 (D) × 4.84 (H) in. (Maximum dimensions) Volumetric capacity: Approx. 188 cc	
Weight	Approx. 242 g (8.5 oz.) (including battery pack and card) Approx. 225 g (7.9 oz.) (camera only [without battery pack and card])	

Camera connectors

USB AV (communication/audio and video output) terminal	Audio output	Monaural
	Video output	Composite video, NTSC color TV system/PAL TV system (switchable from the Option Setting Menu)
	USB	USB 2.0 High Speed PC camera: USB video class
HDMI terminal		Video output Total number of scan lines (effective number of scan lines): 750p (720p)/ 1125i (1080i)/525p (480p) Audio output: L-PCM 48 kHz sampling

Battery life

Shooting	Still image shooting mode	Approx. 200 images: CIPA standard (when a SanDisk 2 GB SD Memory Card is used)
	Video clip recording mode	Approx. 60 minutes: Recorded in FullHD mode
Playback		Approx. 210 minutes: Monitor on, continuous playback

- Until battery pack runs out when using a fully charged battery pack at a 25 °C (77 °F) ambient temperature.
- The operation time may vary depending on the conditions of the battery pack and the conditions of use. Especially when used at temperatures below 10 °C (50 °F), the battery pack operation time is significantly reduced.

Possible No. of Images/Possible Shooting Time/ Possible Recording Time

Shooting/ recording mode	Resolution setting	Internal Memory	SD Memory Card	
			8 GB	16 GB
Still image mode	16M	6 images	1,200 images	2,340 images
	12M	8 images	1,480 images	2,890 images
	14M(H)	6 images	1,130 images	2,210 images
	14M(S)	9 images	1,690 images	3,300 images
	10M	12 images	2,240 images	4,370 images
	2M	59 images	10,800 images	21,100 images
	2M	64 images	11,300 images	22,000 images
	0.9M	119 images	20,700 images	40,400 images
	0.3M	275 images	49,800 images	97,100 images
	14M(L)	9 images	1,690 images	3,300 images
	2M(L)	64 images	11,300 images	22,000 images
Video clip mode	Full-HD	18 sec.	1 hr. 1 min.	2 hr.
	Full-SHQ	24 sec.	1 hr. 21 min.	2 hr. 38 min.
	HD-HR	24 sec.	1 hr. 21 min.	2 hr. 38 min.
	HD-SHQ	32 sec.	1 hr. 46 min.	3 hr. 27 min.
	TV-SHQ	1 min. 18 sec.	4 hr. 19 min.	8 hr. 25 min.
Audio recording mode		22 min.	67 hr.	130 hr.

- If the continuous recording time of a voice memo exceeds about 13 hours, the recorded file is saved once, and then recording continues in a new file. In the video clip recording mode, when the size of the file being recorded exceeds 4 GB, the recorded file is saved once, and then recording continues in a new file. (These 4 GB segments are automatically created. The recording session continues until you stop recording, but voice memo recording is temporarily interrupted while the file is being saved.)
- The above values apply when an SD Memory Card by SanDisk is used.
- Even with cards of the same capacity, the amount of data that can actually be stored may differ depending on the card brand, etc.
- The continuous shooting time for each video clip will differ depending, for example, on the card capacity, environmental conditions (temperature and shooting conditions, etc.).

Concerning the multi-indicator

The camera's multi-indicator will light, flash, or be off, depending on the different camera operations.

Color	Multi-indicator status	Camera status	
Green	Lit	Connected to a computer or printer	
	Flashing	Power save mode active	
Orange	Lit	Connected to a TV	
Red	Lit	Charging	
	Flashing	Slow	Rise in internal temperature
		Fast	During self-timer photography
		Very fast	Accessing card

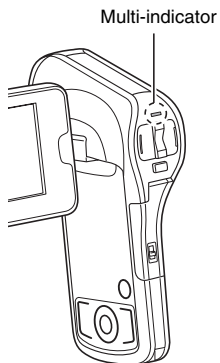

Supplied AC adaptor

Part number	VAR-G12	
Power source	AC 100 V to 240 V, 50/60 Hz	
Rated output	DC 5 V, 1.0 A	
Ambient environment	Temperature	0 to 40 °C (32 to 104 °F) (operation), -20 to 60 °C (-4 to 140 °F) (storage)
	Humidity	20 to 80% (no condensation)
Dimensions	50.0 (W) × 32.8 (D) × 48.9 (H) mm 1.97 (W) × 1.29 (D) × 1.93 (H) in. (not including plug)	
Weight	Approx. 41 g (1.4 oz.) (not including plug)	

Supplied Li-ion battery pack

Model number	DB-L80	
Voltage	3.7 V	
Capacity	700 mAh	
Ambient environment	Temperature	0 to 40 °C (32 to 104 °F) (during use) -10 to 30 °C (14 to 86 °F) (storage)
	Humidity	10 to 90% (no condensation)
Dimensions	39.2 (W) × 5.9 (D) × 31.4 (H) mm 1.54 (W) × 0.23 (D) × 1.24 (H) in.	
Weight	Approx. 15 g (0.5 oz.)	

Others

Mac OS is a trademark of Apple Inc., registered in the U.S. and other countries.

Microsoft and Windows are registered trademarks of Microsoft Corporation in the USA and other countries.

Intel and Pentium are registered trademarks of Intel Corporation (USA). In this manual, the Microsoft® Windows® 2000 operating system, Microsoft® Windows® XP operating system, Microsoft® Windows® Vista operating system, and Microsoft® Windows® 7 operating system are collectively referred to as "Windows".

Software Red Eye by FotoNation™ 2003-2005 is a trademark of FotoNation® Inc.

Red Eye software© 2003-2005 FotoNation In Camera Red Eye - covered by U.S. Patent No. 6,407,777. Other patents Pending.



SDXC logo is a trademark of SD-3C, LLC.



HDMI, the HDMI logo and High-Definition Multimedia Interface are trademarks or registered trademarks of HDMI Licensing, LLC.



Eye-Fi is a registered trademark of Eye-Fi, Inc.

All other company and product names are registered trademarks or trademarks of their respective owners.

CAUTION

- It is forbidden to copy this manual, whole or in part, without prior written permission.
- All images and illustrations given in this manual are for explanation purposes and may differ slightly from that of the actual product. Also, actual specifications are subject to change without prior notice and therefore may differ from the contents of this manual.

Before capturing those important shots, be sure to first take a test shot to confirm that your camera is set up and ready to go

- Sanyo Electric shall not be held responsible for any problems resulting from the use of this camera.
- Sanyo Electric declines all responsibility for damages due to improper use of the camera, failure to adhere to the instructions given in this manual, or repairs or changes done by those other than a technician authorized by the manufacturer.
- Sanyo Electric shall not be held responsible for any damage caused by optional devices or consumable items used with the camera other than those supplied with the camera or those specified by Sanyo Electric.
- Sanyo Electric shall not be held responsible for any losses or loss of revenue resulting from the loss of data caused by the malfunction, or the repairing of a malfunction, of the camera.
- The images captured with this camera will differ in quality from pictures taken with a standard film camera.



HINTS FOR TAKING PICTURES

Taking great pictures in difficult surroundings is easier than you might think. By keeping a few points in mind and choosing the correct settings, you can create photos that you'll be proud to display and share.

If images are blurred even when the autofocus is used

Your camera employs an autofocus function. When you snap a picture using the autofocus, the camera automatically adjusts the settings so that the image will be in focus. If you are getting blurred images even when using the autofocus, one or more of the following might be the reason.



■ How the autofocus works

The autofocus is activated when the [] button is gently pressed halfway. Press the [] button slightly, and the target mark will appear on the monitor to indicate that the autofocus has been activated. Next, continue to gently press the [] button all the way to snap the picture. This two-step method is the way to ensure that your photos are perfectly focused.

■ Reasons for unfocused images

- ① The [] button was pressed all the way in one step.
- ② After the image was focused, the subject moved.
 - Even if camera focuses the subject once, if the distance between the camera and the subject is changed, the subject may become out of focus.
- ③ The focus setting is not set for the correct distance.
 - If you shoot a close-up subject with the camera set to the normal focus mode, or if you shoot a subject at normal distance with the camera set to the super macro (close-up) mode (pages 48, 57 and 89), the image will not be in focus.

■ Preventing blurred images



- ① Confirm that the camera is set to the correct focus mode for your subject.
- ② Hold the camera correctly, and press the [] button halfway.
- ③ Wait for the target mark to appear in the monitor, and holding the camera steady, gently continue to press the [] button all the way down.

Following these steps for a gentle but firm pressing of the [] button will ensure that you get beautifully focused photos.

Photographing a moving subject

Situation: You would like to snap an action shot of a moving child or pet. The autofocus is activated, but because the subject is moving, the image may be blurred. In particular, when the distance between the camera and the subject is changing, it is difficult to lock the focus on the subject. Here are some hints for successfully capturing images of moving subjects.

■ Reasons for unfocused images

When the [] button is gently pressed halfway, the camera's autofocus works by determining the distance between the camera and the subject. Once the subject is in focus, if it then moves before the picture is snapped, the image may be out of focus. This often happens when you once lock the focus on a subject and then wait for the right moment to snap the picture. And, conversely, a blurred image may result if you press the [] button all the way in one step in an attempt to quickly capture an action scene, thus failing to activate the autofocus in time.

■ Preventing blurred images (How to use the manual focus [page 89])

In addition to the autofocus, a manual focus mode is also incorporated in your camera. In the autofocus mode, the distance between the camera and the subject is automatically determined when you press the [] button halfway. In contrast to this, with the manual focus mode, you manually set the focus by specifying the correct distance between the camera and the subject before taking the picture.

■ How to photograph a moving subject

- ① Set the camera's focus mode to the manual focus. Set the focus distance to the correct distance between the camera and the subject.
- ② When the subject is at the set focus distance, gently press the [] button all the way down.

<Advantage of using the manual focus>

- Images can be quickly captured without waiting for the autofocus to activate.
- Because you are presetting the focus distance, the focus can be more accurate.

<Using the manual focus effectively>

- When photographing a moving subject, press the [] button just before the subject reaches the focus distance, and the shutter will be released when the subject is at the correct distance.
- Use manual focus to avoid incorrectly focused images when there is an object between the camera and the subject you wish to focus on.

Shooting portraits (portrait mode)

Points:

- Choose a background that doesn't detract from your subject.
- Move in close to your subject.
- Pay attention to lighting and how it affects your subject.

NOTE

- If the background is distracting, it will not show your subject to his best advantage. Move in closer to your subject or zoom in so that the background does not compete with the subject.
- In portrait photography your subject is clearly the central figure, so try techniques that allow the subject to stand out.
- If light is coming from behind your subject (backlit), his face will appear dark. You can get a better picture by using the flash, for example, or changing the exposure compensation setting.

Photographing moving subjects (sports mode)

Points:

- Match the camera's movement with that of the subject.
- Set the zoom to the wide end (wide-angle).
- Don't be too hesitant to press the [] button, or you'll miss the action.

NOTE

- Tips to not missing those great action shots: Make sure you're holding the camera correctly. Keep the subject in the lens at all times, moving the camera with him while waiting for the right shot. Move your whole body—not just your arms—with the camera while shooting.
- Blurred images are more likely when the zoom is set to the tele end than the wide end. Set the zoom as close as possible to the wide end.
- Learn to press the [] button quickly yet smoothly the instant your photo chance occurs.

Night photography (night view portrait mode)

Points:

- Avoid camera shake.
- Increase the ISO sensitivity.

NOTE

- Camera shutter speed during night photography is considerably slower, so there is a much greater chance that your photographed images will be blurry. Stabilize the camera when shooting.
- You can photograph your subject with the night scene in the background by using the flash. Be careful not to shoot too close to the subject, however, or your subject's face will appear too bright.
- After the flash operates, keep the camera and the subjects motionless for about 2 seconds.

Photographing scenery (landscape mode)

Points:

- Shoot using a high resolution.
- For zoom photography, use the optical zoom.
- Pay attention to picture composition.

NOTE

- When shooting with a wide-angle setting, or if you intend to enlarge the photo, the higher the resolution, the better.
- To zoom in on distant scenery, it's better to use the optical zoom. Using the digital zoom produces a coarser image. Hold the camera securely, keeping your elbows close to your body and making sure the camera is stable. Taking care to stabilize the camera will increase the likelihood of getting a clear photo.
- Don't forget to pay attention to picture composition; note perspective and be aware of how the placement of objects affects the scene.

SANYO

SANYO Electric Co., Ltd.