

603B

MINI-LAB

s Pty. Ltd.

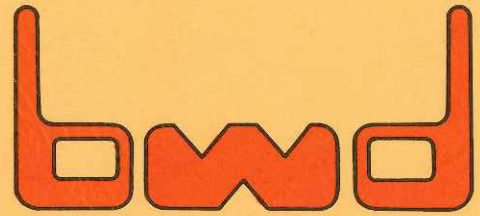

603B

MINI-LAB

s Pty. Ltd.



603B

MINI-LAB

BWD Precision Instruments Pty. Ltd.

Head Office, Manufacturing, Sales and Service
5 Dunlop Road,
MULGRAVE Phone: (03) 561 2888 (3 lines)
VICTORIA 3170 Cables: "OSCOPE" MELB.
AUSTRALIA. Telex: AA 35115

Postal Address
PO BOX 325
SPRINGVALE
VICTORIA 3171

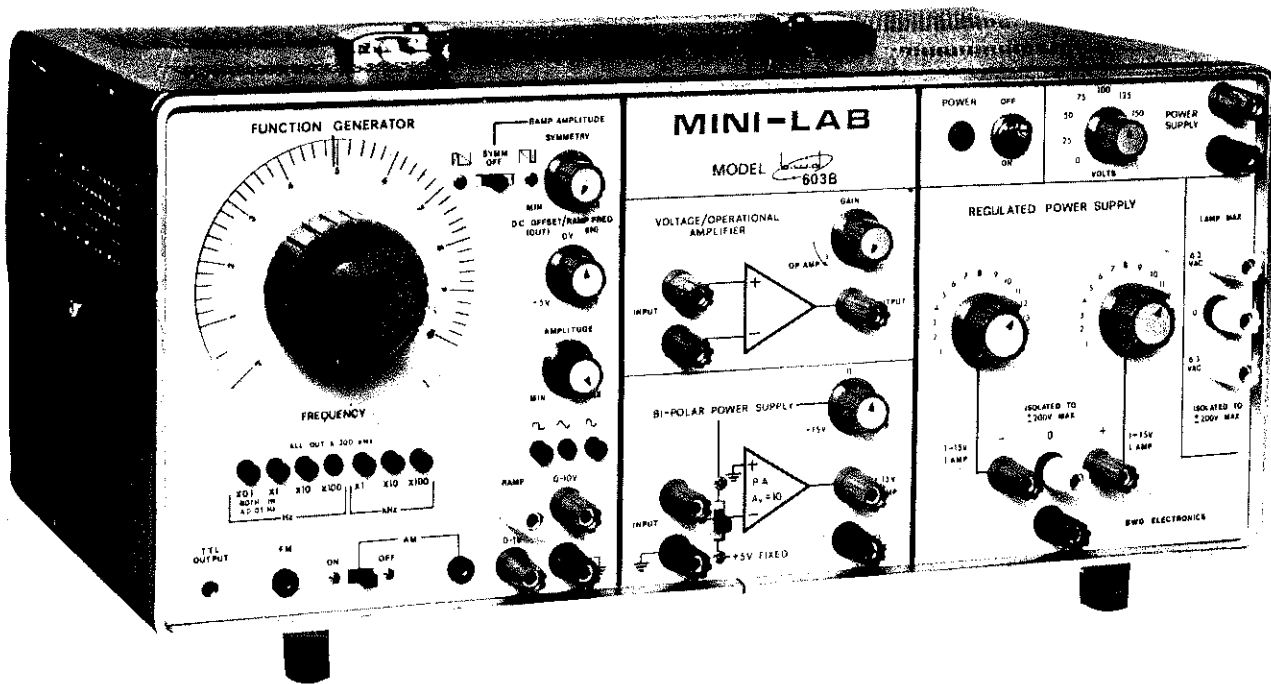

**BWD 603B
MINI-LAB**

TABLE OF CONTENTS

SECTION	DESCRIPTION
1	GENERAL
2	PERFORMANCE
3	CONTROLS AND THEIR FUNCTIONS
4	OPERATION
5	APPLICATIONS
6	CIRCUIT DESCRIPTION
7	ALIGNMENT
8	MAINTENANCE
9	REPLACEMENT PARTS
10	GUARANTEE
11	PARTS LIST

INSTRUMENT HANDBOOK

MODEL BWD 603B MINI-LAB

1. GENERAL:

The MINI-LAB provides seven independent instruments in a single compact cabinet for use in the laboratory or classroom to supply signals and power for a wide range of measurements and experiments in the fields of electronics, chemistry and bio-medical engineering.

The functions available include:-

- (a) Sine, square, triangle, pulse and ramp generator with variable symmetry and D.C. offset controls producing a wide variety of waveforms from 0.001Hz to 1MHz which can be amplitude and frequency modulated by an external signal.
- (b) A ramp generator 5 sec to 50m sec.
- (c) A switched power amplifier/bi-polar power supply/5 Volt supply combination.
- (d) An operational Amplifier with variable gain.
- (e) Two variable power supplies -1 to -15V and +1 to +15V at .1 Ampere output.
- (f) A 0 ▶ + 200V variable power supply.
- (g) A centre tapped 12.6V A.C. supply, and
- (h) Numerous instrument combinations by link interconnection.

2. PERFORMANCE:

Function Generator:

- 2.1 Waveform: Sine, triangle or square, pulse and ramp with amplitude or frequency modulation.
- 2.2 Frequency range: 8 Decade ranges calibrated from 0.01Hz to 1MHz plus a 200kHz to 2MHz range. An additional uncalibrated section of the dial extends range to 0.001Hz. Dial covers 2 decades on each range.
Calibration: $\pm 3\%$ of full scale 10Hz - 1MHz.
- 2.3 Voltage output: Two simultaneous levels 10 Volts p-p open circuit, 5 Volts p-p into 600 Ω .
1 Volt p-p open circuit, 0.5 Volts p-p into 600 Ω .
- Variable output provides continuous control of >100:1 of both outputs whilst maintaining a constant 600 Ω output impedance. Outputs, overvoltage and short circuit proof.
- Sinewave output level: Less than $\pm 2\%$ level variation over calibrated frequency range into 600 Ω $\pm 5\%$ between 1 and 2MHz.
- 2.4 Output offset: Output normally centered symmetrically about ground. Push/pull switch applies a continuously variable 0 to ± 5 Volts offset voltage on open circuit. Control also doubles as ramp frequency control (see 2.8 below).
NOTE: 0-1V output has $\pm 0.5V$ offset.
- 2.5 Symmetry (fixed): $\pm 2\%$ from 0.01Hz to 1MHz (calibrated portion of dial).
Symmetry (variable): Pulse or ramp waveforms. Continuously variable from 1:1 to over 1:50 or 50:1 by switch selection. Applies to sine, triangle or square waveforms. Variable control also doubles as ramp amplitude (see 2.8 below).
- 2.6 Sine wave distortion: <1.5% 10Hz to >50kHz <2% at 1MHz (typically 0.6% 20Hz to 50kHz).
Square wave rise time: 100nsec into 600 Ω load and <50pf capacitance.
Triangle linearity: >99% within calibrated range on dial up to 100kHz.
Triangle symmetry: Better than 2% within calibrated range up to 100kHz.
- 2.7 Frequency modulation: Function Generator can be swept over 2 decades by the internal ramp generator or over 4 decades by an external log sweep. It can also be used as an externally programmed oscillator over a 10,000/1 frequency range.
Input: 1 Volt/dial division.
Input impedance: 25K Ω .
Linearity: 2%.
Input frequency: DC to >10kHz.
- 2.8 Sweep ramp generator:
Output voltage: 0 to >+10 Volts with a continuously adjustable upper limit from +0.6 to +10 Volts using the variable symmetry control in the OFF mode.
Ramp duration: >4 sec to 65m sec approximately.
Continuously adjustable by the OFFSET control in the OFF position.

When coupled into the FM socket, the Function Generator will sweep from the frequency selected by the dial up to the frequency set by the ramp amplitude control. An automatic circuit prevents the sweep exceeding the dial range. Horizontal drive to oscilloscope or recorder is also taken from ramp output via the voltage amplifier (see 2.14) to set drive voltage and polarity required.

2. PERFORMANCE (continued)

2.9 Amplitude Modulation: 0 to 100% modulation all output waveforms from 0.001Hz to 2MHz.

Input: 4 volts p-p for 90% modulation.

Input resistance: approximately 10K Ω .

Modulation input range: DC to 250kHz. An input voltage may also be used to control the output level remotely from 0.5 to 20 volts p-p. NOTE: Unmodulated carrier output level is 10 volts p-p, and 20 volts p-p at peak modulation (open circuit). Both AM and FM modulation can be applied simultaneously.

2.10 TTL Output: Identical pulse width to main output. > 3 volts output into 2 TTL inputs. <80n sec rise and fall time.

Selectable Power Source:

2.11 Amplifier

Gain: Voltage, fixed x10. Input 3 volts p-p for 30 volts p-p output maximum.

Current gain approximately x5000.

Input: 10K Ω , inverting input only.

Frequency response: DC to >80kHz at 20 volts p-p into 15 Ω .

Rise time: < 5 μ sec for \pm 10 volts output swing.

Maximum output: \pm 15 volts minimum \pm 1 amp current (automatic overload). 7 Watts RMS into 15 Ω load. \pm 15 volts into >15 Ω .

Distortion: <0.1% at 1kHz increasing to <0.5% at 20kHz at full output (\pm 15 volts into 15 Ω).

Hum and noise: 60db below max. output (<30mV p-p).

Output impedance: <0.2 Ω .

2.12 Bi-Polar power supply

Voltage Range: Continuously variable from + 15 volts through zero to -15 volts.

Current 1 amp maximum at any voltage setting (automatic overload).

Output impedance: <0.2 Ω .

Hum and noise: <25mV p-p (5mV rms) at full output (15 volts at 1 amp).

2.13 Fixed power supply:

Voltage + 5 volts

Current 1 amp with automatic overload

Output impedance: <0.5 Ω .

Hum and noise: <25mV p-p at full output (8mV rms).

Voltage/Operational amplifier:

2.14 Amplifier

Gain: Continuously variable from x1 to x100 approximately.

Input: Balanced 10K Ω each side to ground with gain control in circuit.

Input overvoltage proof.

Frequency response: DC to > 80kHz - 3db at all gain settings.

Slew rate: 4V/ μ sec.

Output Impedance: <500 Ω (short circuit proof).

Output noise at X100 gain (input open circuit): <40mV p-p.

2. PERFORMANCE (continued)

2.15 Operational amplifier

Input $0.5M\Omega$ isolated by switch

Performance characteristics see fig. 2 a and b.

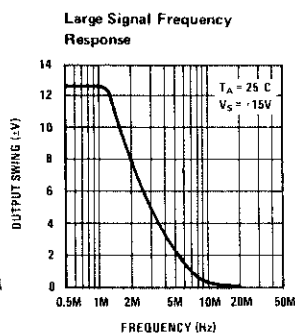

Fig. 2a

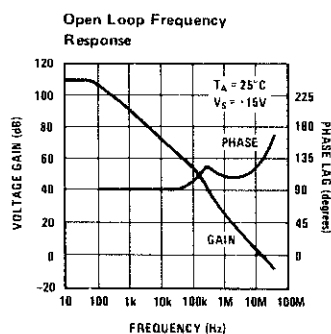

Fig. 2b

Low Voltage Power Supplies:

- 2.16 Voltage output: Two independent variable outputs with a common but isolated zero line (200 volts DC isolation).

Range $+1\frac{1}{2}$ to +15 volts and $-1\frac{1}{2}$ to -15 volts or a single ± 3 to 30 Volts.

Current output: 1 amp maximum each output - overload protected.

Regulation: 1% for 10% line change, or 0 to 1 amp load change.

(Typically <0.5%).

Hum and noise: <5mVRMS at full load.

NOTE: Minimum voltage approximately 1V to 2V.

High Voltage Power Supply:

- 2.17 Specifications apply at a nominal input voltage of 235/117 volts AC. Voltage output 0 to 200 volts DC. 30m amp available at 175 volts DC. 20m amps at 200 volts DC. Constant current overload at approximately 40m amp.

Output referred to ground.

Regulation: 1% for 10% line change from nominal input voltage, or 0 to 30m amp load change measured at 150 volt output.

Hum and noise: <25mV RMS at full output.

AC Supply:

- 2.18 Voltage and current 6.3 volts to 0 to 6.3 volts 1 amp each side. Completely isolated and each 6.3 volt leg is separately fused.

Facilities by Interconnection:

- 2.19 Power Waveform Output (2.1 with 2.11)

Function generator linked to power amplifier.

Frequency range: 0.001Hz to >80kHz.

Output: 0-30 volt p-p with 1 amp capability. Output may be symmetrical or offset about ground to ± 15 volt p-p (minimum).

- 2.20 A.M. Modulation at Line Frequency. (2.9 with 2.18).

With 6.3Volt AC supply linked to A.M. input via a $39K\Omega$ resistor, sine output will be 90% approximately A.M. modulated. Carrier output range 0.001Hz to 2MHz.

2. PERFORMANCE (continued)

- 2.21 F.M. Modulation at Line Frequency (2.7 with 2.18)
Linked as for A.M. but to F.M. socket with a 39K Ω resistor, sine, square or triangle will be swept over a decade range of calibrated dial frequency.
- 2.22 Swept Output (2.7 with 2.8)
The function generator output may be swept over the entire 2 decade range of the dial on any range or down to <10% of any portion of the dial.
- 2.23 High Sensitivity Power Amplifier (2.11 with 2.14)
With operational amplifier linked to power amplifier.
Output: As for power amplifier specification.
Voltage gain: Continuously variable from x10 to x1000.
Frequency response: DC to > 20kHz.
- 2.24 Function Generator Op Amp Link (2.1 with 2.14)
Push-pull signals: With generator output linked to inverting input a signal 180 $^{\circ}$ out of phase with the generator is obtained at frequencies up to 80kHz.
 \pm Pulse output: Sharp pulses to >100kHz can be generated by over-driving the op-amp with offset triangular waveforms. Rise time is controlled by degree of overdrive and op-amp gain. Other waveforms such as half sine, log curves, truncated triangular and complex shapes of almost infinite variety can be obtained by combining the wide range of facilities provided.
- 2.25 Power Supply: + 45 volt 1 amp (2.12 with 2.16)
By linking the -15 volt output to the bipolar output, output voltages to +45 volts can be set. By connecting the +15 volt output to the bi-polar supply voltages to -45 volts can be set.
- 2.26 Modulated Power Supply. \pm 45 volt 1 amp (2.1 and 2.11 with 2.16)
If the bipolar supply is switched to power amplifier and its input linked to the function generator the low voltage supply can rise on top of the amplifier output at low frequencies to provide for example, simulated power line ripple.
- 2.27 Other facilities.
The generation of complex waveforms and many experiments and measurements are described in the applications section (Section 5) of this manual.

General Details:

- 2.28 Power requirements:
95 to 135 volts)
190 to 265 volts) 50 - 60Hz, By switch selection (rear panel).
- 2.29 Finish: Light coloured panels and sage green vinyl coated aluminium covers with anodised aluminium surrounds.
- 2.30 Warranty: The instrument is guaranteed for a period of twelve (12) months against faulty materials and workmanship.
- 2.31 Dimensions: 420mm (16 $\frac{1}{2}$ ") wide x 200mm (8") high x 260mm (10-1/4") deep.
Overall knobs, etc.

2. PERFORMANCE (continued)

General Details (Cont'd)

2.32 Weight: 10kg (21 lbs) net, 11kg (24 lbs) packed.

2.33 Safety Standards: This instrument is designed to closely conform to IEC 348 recommendations.

2.34 Ordering Code: BWD 603B.

Accessories:

Dust Cover Part No. D28.

For full range of accessories suitable for educational experiments, see separate list of 600 accessories.

2.35 Additional Products:

Oscilloscopes: A wide range of instruments are manufactured by BWD Instruments from single channel 6MHz to dual trace 100MHz oscilloscopes including storage oscilloscopes to display, measure or store your 'MINI-LAB' waveforms.

600 SERIES ACCESSORIES:

600B Electromagnet with 1 metre leads and 19mm square 75mm long pole piece.

600C 24V lamp mounted with leads and plugs.

600D Microphone with 1 metre screened lead and input plugs.

600E Interconnecting leads, 1 metre long, fitted with 4mm stacking plugs.

600F 7 Pin valve base on stand. Complete with 6AU6 valve.

600G Transistor mounted on stand. Complete with 2N3054 silicon NPN power transistor.

600H 4 Silicon diodes (2 amp). Diodes type BYX21-200.

600I 400kHz - 2mHz parallel resonant circuit and detector diode.

600L R.C. charging circuit. Time constant 1 sec.

600M L.C. charging circuit. Time constant 1 sec.

600N 30Ω 100mm loudspeaker on stand.

2. PERFORMANCE (continued)

600 Series Accessories (continued)

600P C.L. & R phase and impedance circuit.

600Q Low voltage relay with change over contacts.

These are but a sample of the wide range of accessories available for educational fields in electronics and electrical engineering from BWD PRECISION INSTRUMENTS PTY. LTD.

3. CONTROLS AND THEIR FUNCTIONS:

The front panel is divided into three major sections:-

- 3.1 Signal Source, comprising of a function generator, pulse output, amplitude modulator and a ramp generator.
- 3.2 Amplifier section, containing a switchable Power Amplifier/Bi Polar Power Supply, and a switchable Voltage/Operational Amplifier.
- 3.3 Power Supply section, containing three independently variable power supplies and one AC source at line frequency.

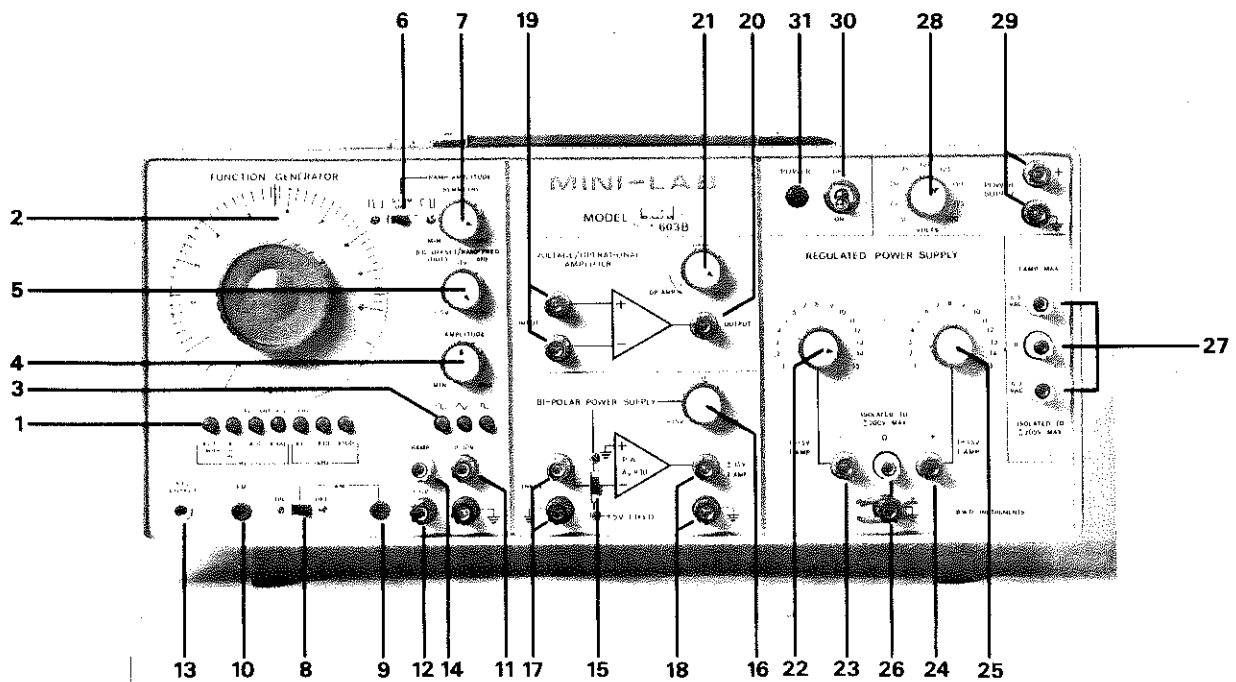

3.4 Signal Source Controls.

1. Frequency Range Switch: Desired frequency range can be obtained by depressing the correct button. When the x0.1 and x1 buttons are depressed simultaneously the resultant frequency is x0.01 and with all buttons out x200kHz.
2. Frequency Dial: Calibrated from 1 to 10 with an additional 0.1 marking and is used in conjunction with the Frequency Range Switch to set the output frequency.

3. CONTROLS AND THEIR FUNCTIONS (continued)

3.4 Signal Source Controls: (cont'd)

3. **Function Selector:** Three outputs are available by selection of the correct button, sine, square or triangle.
4. **Amplitude Control:** Continuously variable control varies output from 0-10 Volts peak to peak.
5. **DC Offset/Ramp Frequency Control:** This control varies the Ramp Frequency. When the knob is pulled out, the DC level of the Function Generator output can also be set to $>\pm 5V$ with respect to ground.
6. **Symmetry Switch:** The three position slide switch provides, either extension of the +ve or -ve going signal, or waveforms with a 1:1 symmetry.
7. **Ramp Amplitude/Symmetry Control:** This control has a dual function.
 - (a) It varies the output amplitude of the Ramp Generator.
 - (b) When the Symmetry Switch selects either +ve or -ve slope extension it adjusts the Magnitude of the extension.
8. **AM on-off Switch:** This switch connects an amplitude modulator into the circuit so that the output selected by the previous controls can be varied in amplitude by a suitable control voltage.
9. **AM Input Socket:** When the AM switch is 'ON' a +ve voltage introduced to the socket will decrease the output and a -ve voltage increase the output.
10. **FM Input socket:** The output frequency of the generator can be controlled by connecting a voltage to the FM input socket. A +ve voltage will increase the frequency above that set by the Frequency Dial and a negative voltage will decrease the frequency.
11. **0-10V Output Terminal:** 0 to 10V p-p of the selected frequency and amplitude is available at an output impedance of 600Ω .
12. **0-1V Output Terminal:** 0.01 to 1.0V p-p of the selected frequency and amplitude is available at an output impedance of 600Ω .
13. **TTL Output Terminal:** A Square wave output from 0V to $>+3V$ is always available at this point.

3. CONTROLS AND THEIR FUNCTIONS (continued)

3.4 Signal Source Controls (Cont'd)

14. Ramp Output: 0 to +10V Linear Ramp is available at an output impedance of 600Ω.

3.5 Amplifier Section Controls:

15. Power Amp/Bi-Polar/+5V Power Supply Switch: Position of this switch provides the user with either a Power Amplifier or a variable +15V to -15V Supply or a fixed +5V Supply.
16. Voltage Control/Bi-Polar Power Supply: With the Bi-Polar Supply in operation, rotation of this control changes the output voltage over a ± 15V range as indicated on the front panel.
17. Power Amplifier Input Terminals: These terminals accept input signals for the Power Amplifier. When not in use, the blue terminal becomes open circuit.
18. Power Amp/Bi-Polar/+5V Power Supply Output Terminals: The output of either the Power Amplifier or the Power Supplies appears here.
19. Voltage/Operational Amplifier Input Terminals: An Inverting (-ve) and a Non-Inverting (+ve) input is provided for both functions of the amplifier.
20. Voltage/Operational Amplifier Output Terminal: The output of either the Voltage Amp., or the Operational Amp. is available here.
21. Voltage Amplifier Gain Control: Varies the gain from 1 (0db) to 100 (40db). When turned maximum anti-clockwise, the feed-back networks are removed converting the amplifier to an Operational Amplifier.

3.6 Power Supply Section Controls:

22. -1 ▶ -15V Voltage Control: Rotation of this control provides a continuously variable output voltage from approx. - 1 to -15V from the:-
23. -1 ▶ -15V Output Terminal: The required load is connected between this terminal and the 0V terminal which is the common return to the:-
24. +1 ▶ +15V Output Terminal.
25. +1 ▶ +15V Voltage Control: Provides a continuously variable output voltage from approx. +1 to +15V.

3. CONTROLS AND THEIR FUNCTIONS (continued)

3.6 Power Supply Section Controls: (Cont'd)

26. 0V to Earth, Link - Is provided so that the common return of the two supplies can be grounded. However, either output terminal can be grounded giving up to + or - 30V.
27. 6.3V-0-6.3V AC Output Terminals: Are the outlets for a centre-tapped winding on the power transformer. The winding is insulated from all other terminals and may be taken to $\pm 200V$ with respect to ground.
28. 0 \blacktriangleright +200V Voltage Control: gives continuously variable adjustment of the output voltage from 0V to +200V.
29. 0 \blacktriangleright +200V Output Terminals: The negative terminal is grounded and the positive terminal supplies 0 to +200V output.
30. Power ON/OFF Switch: A D.P.S.T., switch connects the mains to the power transformer providing power for the entire instrument. When power is being applied to the unit the:-
31. Power Indicator: Lights up giving a visual indication that the unit is operating.

4. OPERATION:

<u>DESCRIPTION:</u>	<u>PARAGRAPH</u>	<u>PAGE</u>
GENERAL	1,2	4 - 2
POWER TRANSFORMER AND AC FUSE	3	4 - 2
FUNCTION GENERATOR	4	4 - 2
FUNCTION GENERATOR DC OFFSET	4	4 - 3
FUNCTION GENERATOR SYMMETRY	4	4 - 3
FUNCTION GENERATOR FREQUENCY SWEEP	4	4 - 4
FUNCTION GENERATOR A. M.	4	4 - 5
POWER AMPLIFIER	5	4 - 5
BI-POLAR POWER SUPPLY	6	4 - 6
+5V FIXED SUPPLY	7	4 - 6
VOLTAGE AMPLIFIER	8	4 - 7
OPERATIONAL AMPLIFIER	9	4 - 7
+ AND -15V VARIABLE POWER SUPPLIES	10	4 - 9
6.3V AC OUTPUT	11	4 - 10
0→200V VARIABLE POWER SUPPLY	12	4 - 11

4. OPERATION (continued)

- 4.1 The purpose of this section is to outline the use of each separate function of Model BWD 603B. For usage requiring interconnection between sections refer to 'APPLICATION, SECTION 5'.
- 4.2 Throughout this section and the following section, drawings of the front panel and its controls are used to describe settings of switches and knobs.
- (a) Where a push button switch is shown, **X** that switch should be depressed. Otherwise the button should be released.
 - (b) The position of knobs is shown by an arrow on the front of the knob. The panel control should be aligned so that the arrow points in the approximate direction as the drawing.
 - (c) Where no arrow appears on the drawing of a particular knob, the position of that control has no effect on the operation.
 - (d) The position of the Frequency Dial is shown by aligning the number shown on the drawing, against the vertical line at the top of the dial.

- (e) Any inputs are designated thus:-

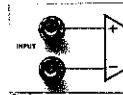

- (f) Outputs are designated thus:-



- 4.3 Check that the power transformer is connected correctly for the mains supply to which the unit will be connected. If the connection is incorrect refer to section 2.28.

Check the fuse rating on the rear panel of the unit and replace if necessary.

The 3 pin plug may now be inserted into the correct receptacle and power applied via the front panel Power ON/OFF switch and any external power switch.

4.4 Operation of the Function Generator:

With the controls set as shown below the three waveforms drawn to the right of the panel can be produced by depressing the indicated push button.

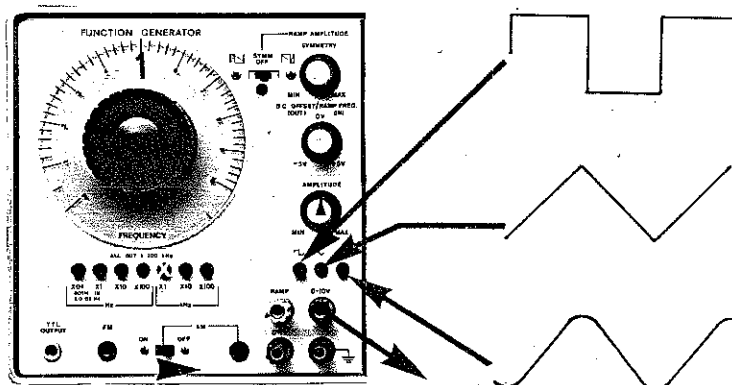

4. OPERATION (continued)

4.4 Operation of the Function Generator (Cont'd)

The frequency of operation will be approximately 1kHz. Variations of the Frequency Dial enables signals within the frequency range of 100Hz to 10kHz to be generated. The frequency does not change when the Function Selector is used to produce the three different waveforms.

The output amplitude can be adjusted via the Amplitude Control from 0.1V pp to 10Vpp from the main output terminal, and from 0.01V p-p to 1.0V p-p from the 0-1V output terminal. A TTL compatible output is permanently available from the terminal marked TTL on the front panel. The phase relationship between the TTL output and the other waveforms is shown below:-

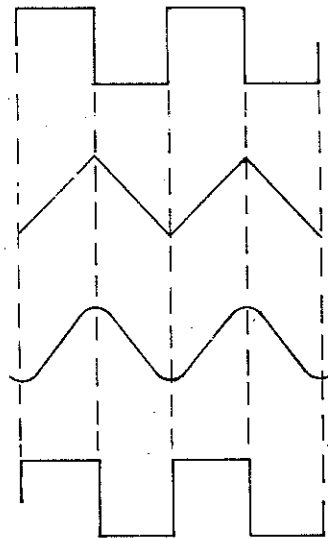

Offset voltage can be superimposed on the output waveform by pulling the Offset Control out until it clicks and then rotating the control either side of the centre point of its rotation. Pushing the knob back in renders the control in-operative.

By setting the symmetry controls as shown below the effect of variable symmetry can be seen:-

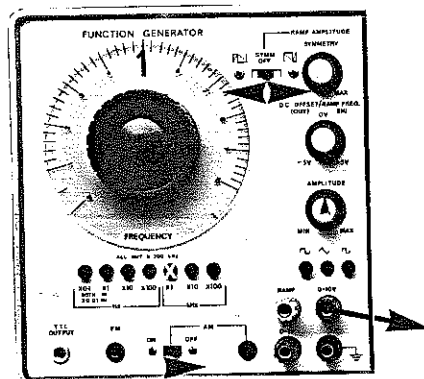

4. OPERATION (continued)

The symmetry change of the waveform is achieved by increasing the time duration between alternate half cycles, hence the overall effect is to decrease frequency as the symmetry ratio changes from 1:1 to either 50:1 or 1:50. The beginning of a cycle of the square wave switching waveform coincides with the peaks of both the Sine and Triangle waveforms. Since the symmetry control works on all three output waveforms the three waveforms appear as below:-

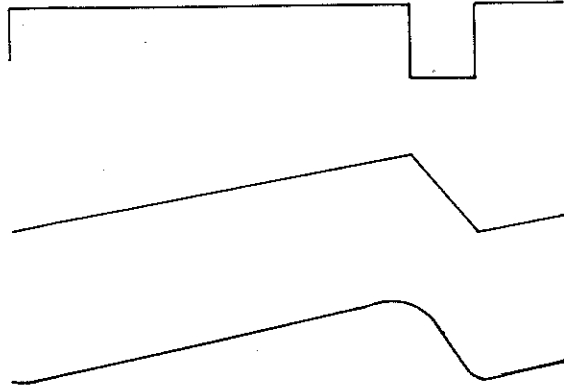

Setting the controls as shown below, the frequency of the generator can be swept over any desired portion of the selected frequency range. The sweep width is adjusted by the Ramp Amplitude control and the starting frequency by the Frequency control. To vary the sweep speed adjust the Ramp Frequency control.

Should the Frequency Control and the Ramp Amplitude control be set such that the upper frequency limit would lie outside the calibrated range, an automatic frequency limiting circuit will re-set the ramp each time it exceeds the calibrated frequency limit.

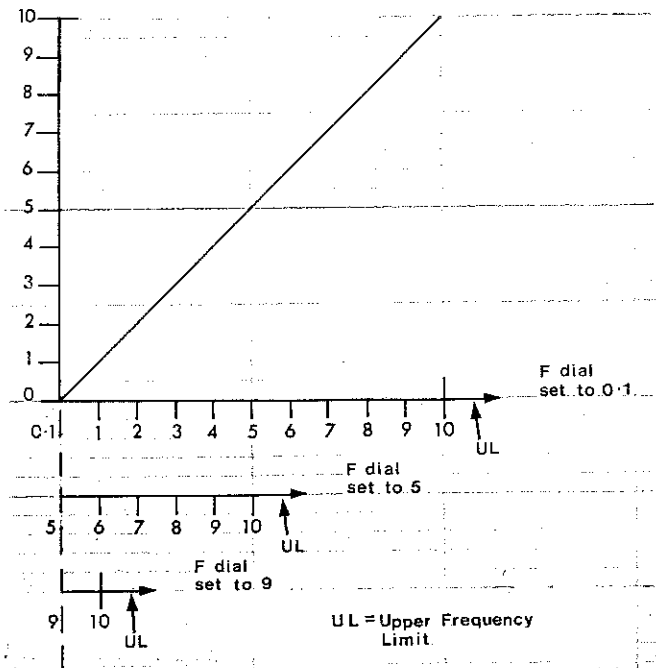
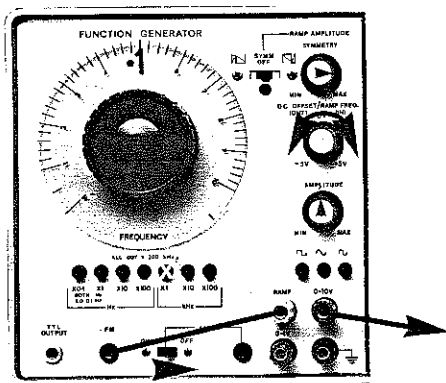

4. OPERATION (continued)

Operation of the Function Generator (continued)

If it is required to control the frequency with an external voltage, the lead from the RAMP output can be disconnected and the external voltage fed into the F.M. input socket. The voltage/frequency relationship is shown by the graph on the opposite page, but no upper limit indication is available.

To show the effect of 50Hz sinewave modulation, connect the 6.3V AC source to the A.M. input as shown to produce the waveform shown below:-

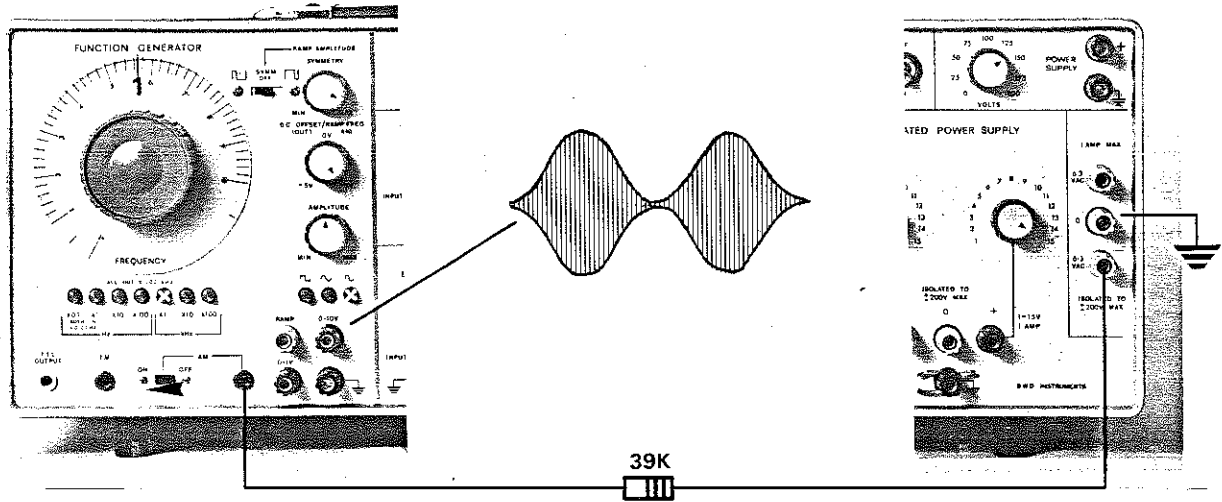

4.5 Operation of the Power Amplifier:

Set the controls as shown below:-

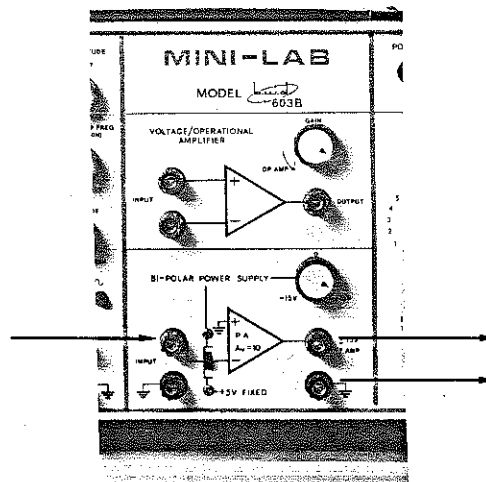

4. OPERATION (continued)

4.5 Operation of the Power Amplifier (Cont'd)

Connect the load where indicated. An input signal can be obtained either externally or from the output of the Function Generator. NOTE: that an input of $\pm 1.5V$ will give an output of $\pm 15V$ which is the maximum specified output, however, if the load impedance is low, the current may exceed $\pm 1A$ and the automatic overload will operate producing a distorted output waveform. To produce an audible output a speaker may be connected as a load.

4.6 Operation of the Bi-Polar Power Supply:

Set the controls as shown below and connect the load across the output terminals.

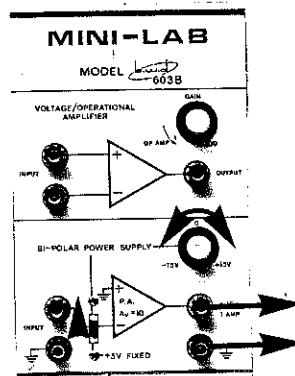

The required output voltage can be set using the Output Voltage Control. For accurate voltage setting an external meter or DVM should be connected across the output terminals.

4.7 Operation of the +5V Fixed Power Supply:

Set the controls as shown below and connect the load across the output terminals. The output voltage will lie between 4.9 and 5.1V from a 0 to 1 amp load.

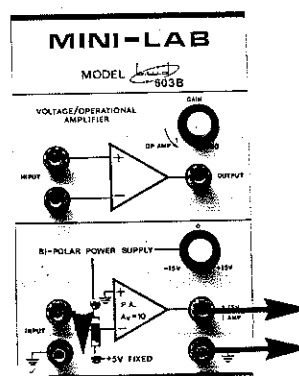

4. OPERATION (continued)

4.8 Operation of the Voltage Amplifier:

Set the gain control to x1 but ensure the control is not switched to 'Operational Amplifier'. The input signal can be connected for inverting or non-inverting output as shown below:

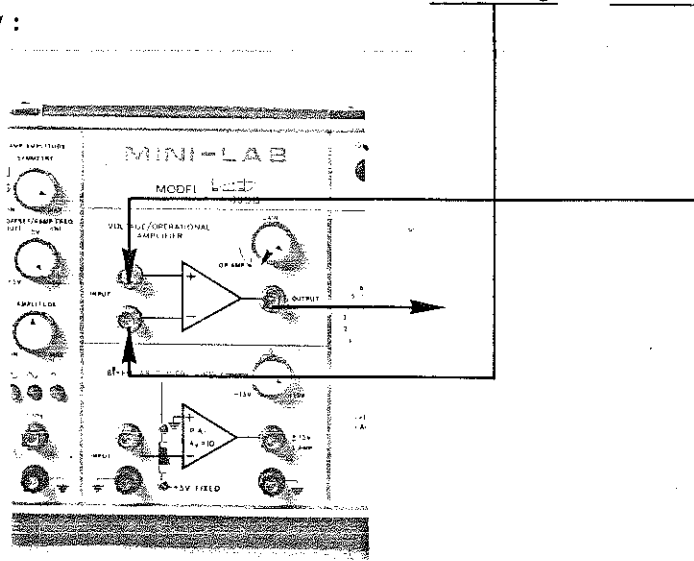

By varying the Gain Control the gain can be adjusted from x1 to x100. NOTE: that the input signal will need to be very small for a gain of 100, i.e. if the input voltage is $\pm 100\text{mV}$ the output voltage will be $\pm 10\text{V}$. The x0.1 output of the Function Generator will give an output from 10mV to 1V p-p, which is suitable for demonstrating the amplifier. NOTE: When using the amplifier, ground the unused input signal.

4.9 Operation of the Operational Amplifier:

Set the Voltage Amplifier Gain control to maximum anti-clockwise ensuring that the rotary switch is switched to 'OP AMP'. The resulting amplifier has open circuit inputs and no negative feedback, giving it a gain of approximately 100db (100,000). For most practical purposes this gain can be considered to be infinite, making the effective gain of any practical circuits dependent on external components. The following circuits can be constructed using the Operational Amplifier and a few external components.

a) VOLTAGE FOLLOWER

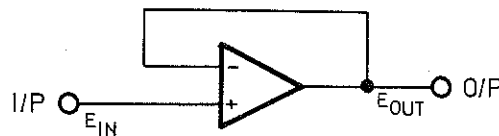

$$R_{IN} > 100\text{M}\Omega$$

$$R_{OUT} < 50\Omega$$

b) NON-INVERTING AMPLIFIER

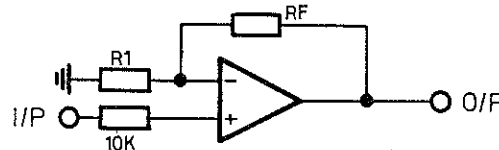

$$A_V = 1 + \frac{R_f}{R_1}$$

c) INVERTING AMPLIFIER

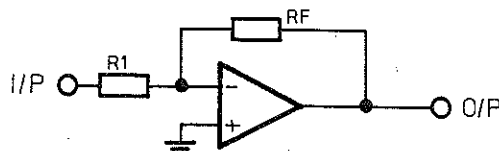

$$A_V = -\frac{R_f}{R_1}$$

4 OPERATION (continued)

4.9 Operation of the Operational Amplifier (Cont'd)

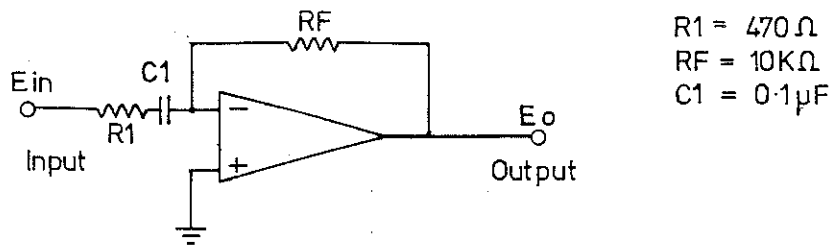

$R1 = 470 \Omega$
 $RF = 10K\Omega$
 $C1 = 0.1\mu F$

$E_{in} = 0.5V_{pp}$ freq. = 1kHz

E_o

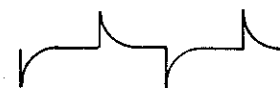

14 Vpp



2 Vpp



3 Vpp

NOTE: To preserve the correct shape of the input waveform the Function Generator output should be amplified by the Power Amplifier which has less than 0.2Ω output impedance and will not be affected by the loading of the input.

Integrator.

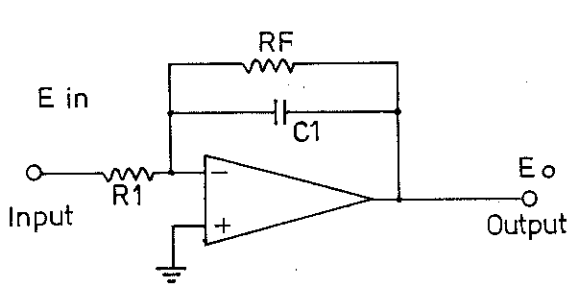

$R1 = 10K\Omega$
 $RF = 100K\Omega$
 $C1 = 0.1\mu F$

$$E_o = - \frac{1}{R1 \cdot C1} \int E_{in} dt$$

$E_{in} = 5V_{pp}$ freq. = 1kHz

E_o



1 Vpp



0.7 Vpp



0.7 Vpp

4. OPERATION (continued)

4.10 Operation of the + and - 15V Variable, Regulated Power Supplies:

The range of the independently variable supplies is 1 to 15 volts. The controls as set below will produce + and - 1V from the terminals indicated:-

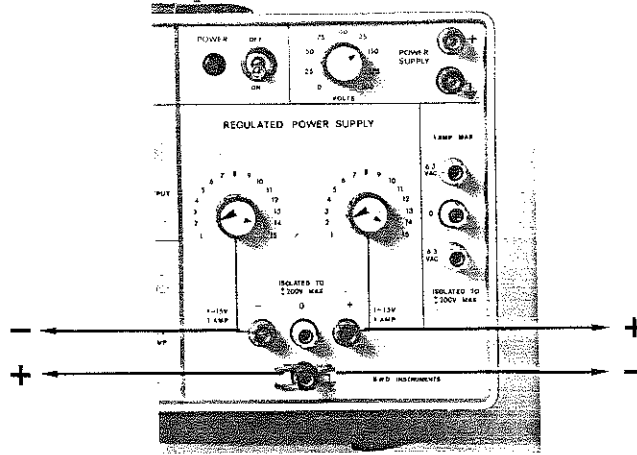

Adjustment of either the positive or negative control will produce, at the corresponding terminal, the voltage indicated by the dial. Both supplies have a common terminal which is isolated from the instrument ground when the earth link is removed.

The supplies can now be connected to produce the following sources:-

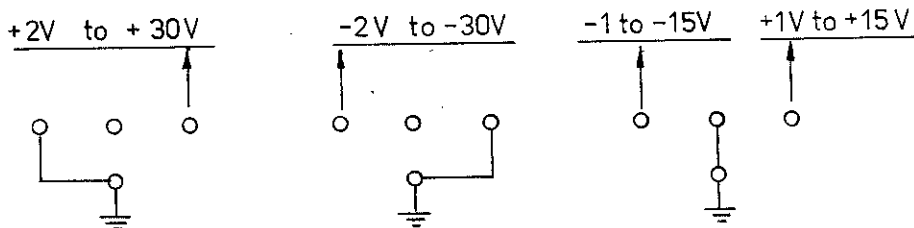

The grounded terminal in the three diagrams above can be taken to + or -200V with respect to ground increasing the range of other supplies or just providing a regulated source elevated from the instrument ground.

The regulation of the output is maintained for output currents up to 1 ampere. Above 1 ampere the automatic overload begins to operate reducing the output voltage as the current increases.

4. OPERATION (continued)

4.11 6.3V - 0 - 6.3V AC Output:

The three terminals provide a centre tapped 12.6V output. Using the C.T. as a common point the phase and approximate amplitude of the waveforms available is shown below:-

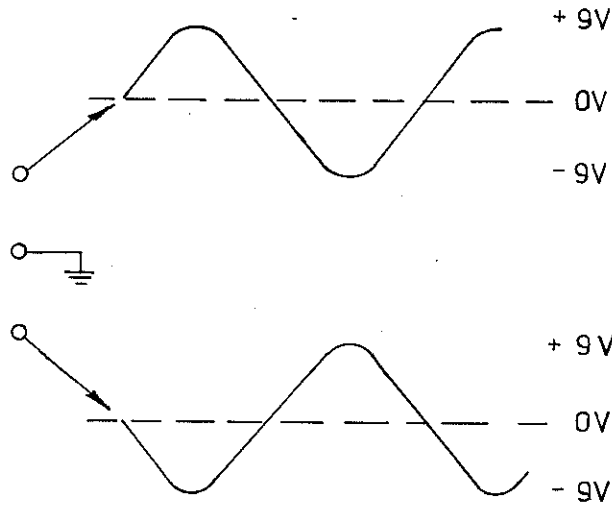

Grounding either end of the winding produces the following waveforms:-

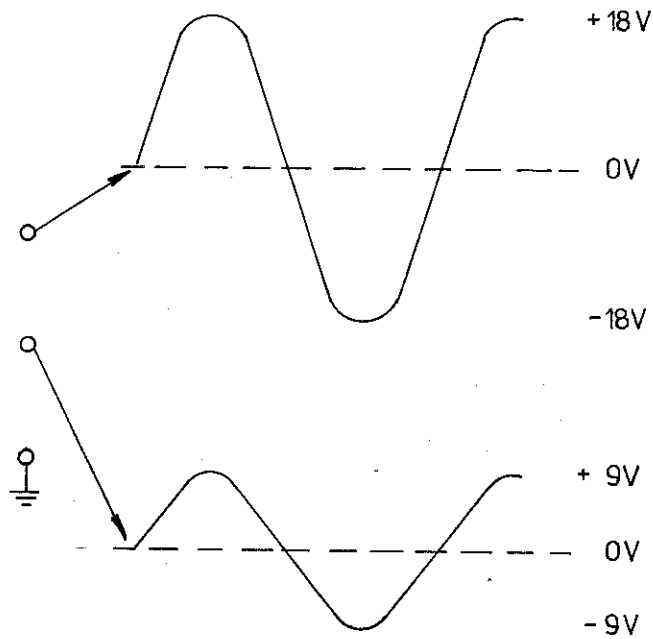

Both ends of the winding are fused so that if zero output is produced at either or both outer terminals check the fuses on the rear panel.

4. OPERATION (continued)

4.12 Operation of the 0 to 200V Power Supply:

The negative terminal of this supply is internally connected to ground. With the Voltage Control adjusted as shown below and the load connected as shown the output voltage will be zero.

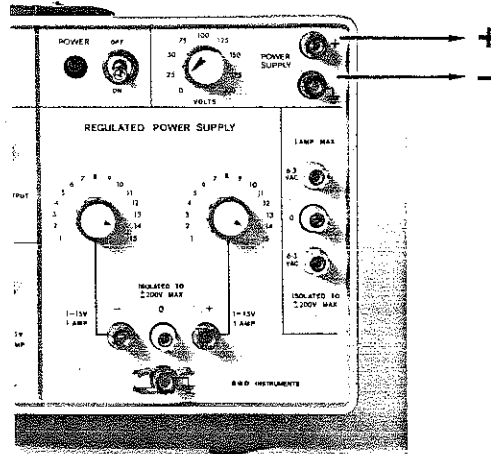

Rotating the Voltage Control clockwise will increase the output voltage to the amount shown on the panel. The output voltage will be maintained for an output current of up to 30mA, any output currents higher than 30mA will cause the supply to go into an automatic overload condition where the output voltage will decrease with increasing current.

APPLICATIONS:

5.1 FREQUENCY MODULATION AND DE-MODULATION:

The aim of this experiment is to demonstrate the production of a Frequency Modulated carrier and to show a means of de-modulating the signal to reproduce the original modulating signal.

Equipment Required:-

- (a) 1x Model BWD 603B Mini-Lab
- (b) 1 x Model BWD 600I Tuned Circuit
- (c) 1x Model BWD 600D Microphone
- (d) 1x Model BWD 600N Loudspeaker
- (e) Various leads
- (f) 1x 0.1 μ F Capacitor
- (g) 1x 560pF Capacitor

The equipment is connected up as shown below:-

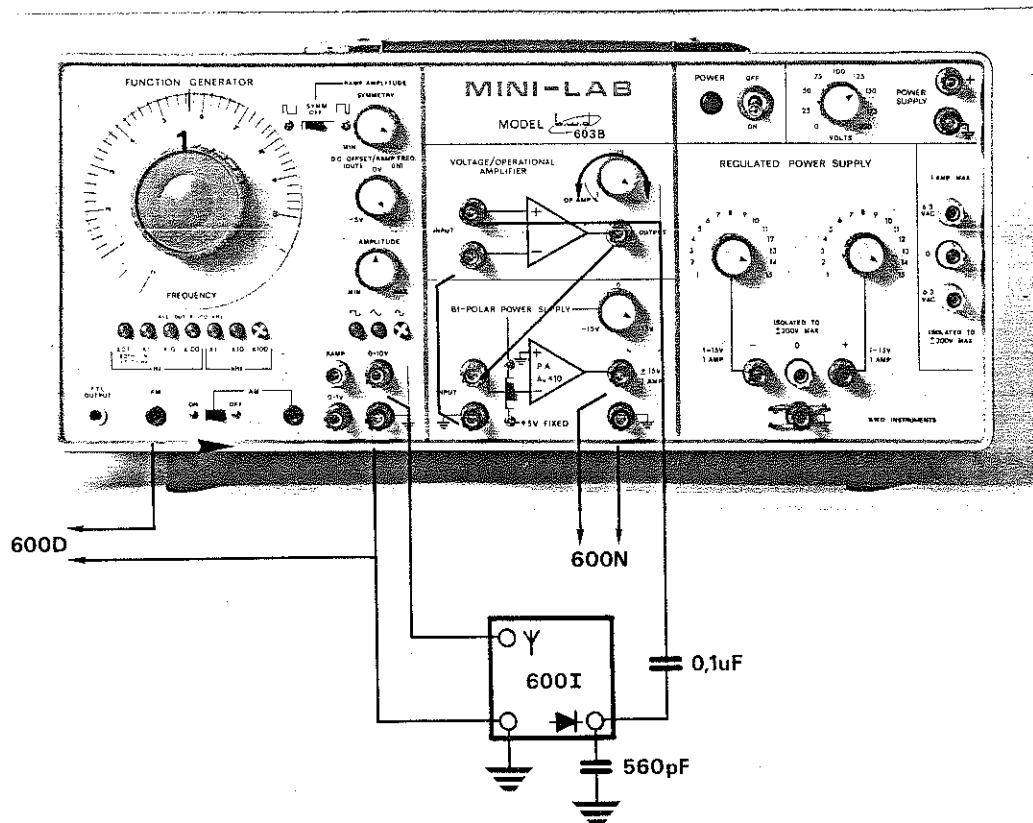

The transmitter section produces the F.M. signal and feeds it into the tuned circuit. By adjusting the tuned circuit so that the centre frequency of the F.M. signal occurs on the slope of the response, a change in frequency will result in a change of level across the tuned circuit. The resultant Amplitude Modulated signal is rectified by the detector diode (the R.F. is removed by C) and amplified by the two amplifiers where it can be heard in the loudspeaker or seen by an oscilloscope.

5. APPLICATIONS: (continued)

5.2 AMPLITUDE MODULATION AND DE-MODULATION:

The aim of this experiment is to demonstrate the production of an Amplitude Modulated carrier and to show a means of de-modulating to produce the original modulating signal.

Equipment Required:-

- (a) 1x Model BWD 603B Mini-Lab
- (b) 1x Model BWD 6001 Tuned Circuit
- (c) 1x Model BWD 600D Microphone
- (d) 1x Model 600N Loudspeaker
- (e) Various leads
- (f) 1x 0.1 μ F Capacitor

The equipment is connected up as shown below:-

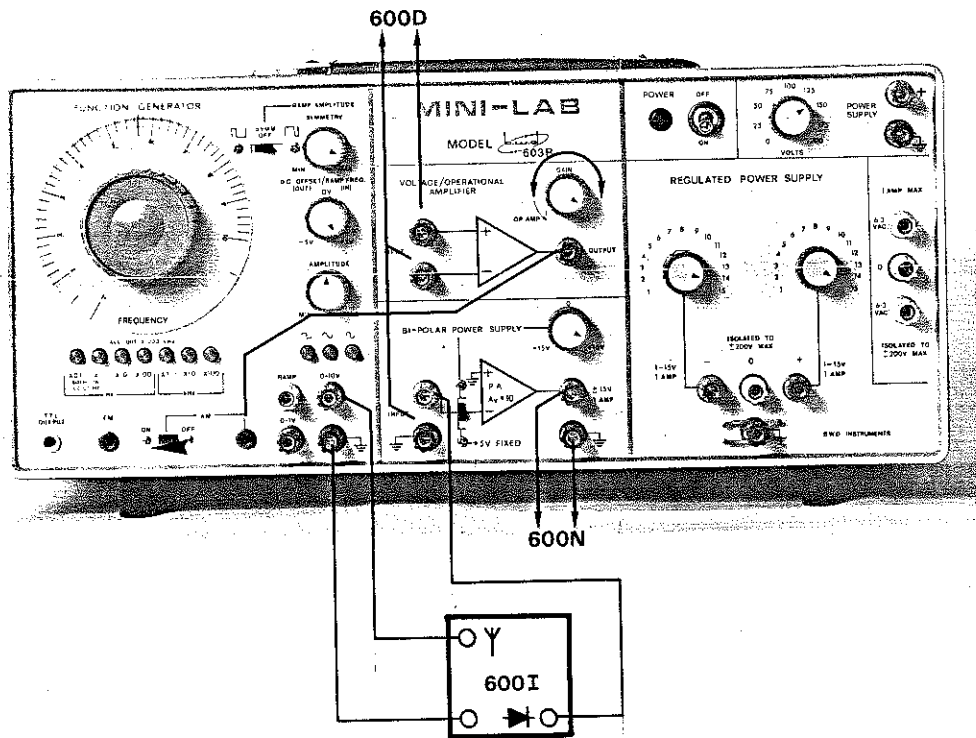

The output from the microphone is amplified by the Voltage Amp. and taken to the A.M. input where it amplitude modulates the function generator output. This A.M. Signal is then tuned by the tuned circuit, detected by the diode and amplified to produce an audible signal.

5.3 METHODS OF OBTAINING FREQUENCY SWEEP IN CONJUNCTION WITH AN OSCILLOSCOPE TO VIEW THE RESPONSE OF VARIOUS CIRCUITS:

(a) Linear Frequency Sweep:

The oscilloscope display shows a linear frequency versus horizontal deflection display. This can be achieved in the following manner:-

First determine the amplitude and D.C. level of the sweep output of the oscilloscope. Using the Voltage amplifier and an attenuator (if necessary), change the sweep waveform so that it starts at zero volts and increases positively to approximately +10 volts.

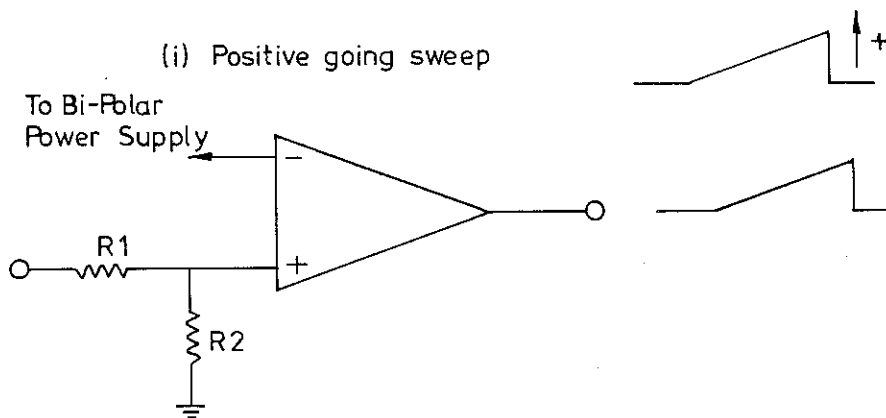

The values of R1 and R2 are set to give less than 10V pp out of the Voltage Amplifier set to unity gain. Variation of the Bi-Polar Power Supply adjusts the D.C. level of the output and is used to set the start of the sweep at zero volts. If the sweep output from the oscilloscope starts at zero volts, the negative terminal of the amplifier may be grounded. The gain control will adjust the peak to peak value of the output signal.

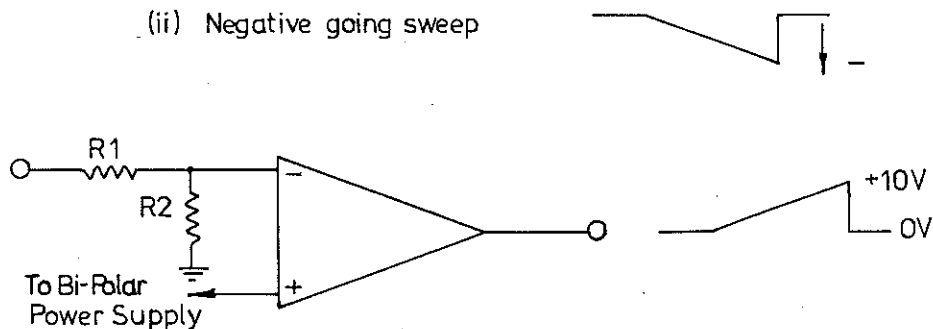

5. APPLICATIONS (continued)

5.3 METHODS OF OBTAINING FREQUENCY SWEEP IN CONJUNCTION WITH AN OSCILLOSCOPE TO VIEW THE RESPONSE OF VARIOUS CIRCUITS (Cont'd)

The values of R1 and R2 are set to give less than 10V pp out of the Voltage Amplifier set to unit gain. Variation of the Bi-Polar Power Supply adjusts the DC level of the output, and is used to set the start of the sweep at zero volts. If the sweep output from the oscilloscope starts at zero volts, the +ve terminal of the amplifier may be grounded. The gain control will adjust the peak to peak value of the output signal.

Having produced the appropriate signal for modulating the Function Generator, the frequency dial of the generator is set to 0.1 and the output of the Voltage Amplifier is connected directly to the F.M. input socket.

The output frequency of the Function Generator will now vary over approximately two decades, starting at the frequency shown by the dial and increasing linearly to the maximum frequency for the frequency range selected.

If a smaller range of frequency modulation is required, e.g. 200Hz to 300Hz the procedure is as follows:-

- (1) Set the minimum frequency required on the dial (200Hz).
- (2) Adjust the amplitude of the modulating signal, either by varying the gain of the amplifier or by adjusting the values of R1 and R2, so that the pp amplitude, in volts, is equal to the number of major scale divisions over which the frequency is to change. (From 200 to 300Hz is one major division). Then check that the start of the sweep is at zero volts and re-adjust if necessary.

(b) Logarithmic Frequency Sweep:

Whereas the linear frequency sweep covers only two decades, changing the shape of the sweep voltage and allowing the start to be below zero volts enables a sweep of up to four decades to be achieved in a manner which is usable. Both the Power Amplifier and the Voltage Amplifier are used; one to amplify the oscilloscope sweep signal and the other to provide a non-linear input/output characteristic.

Several external components are used:-

- 1x 2 Ω 1 Watt Resistor
- 1x 47K Ω $\frac{1}{2}$ Watt Resistor
- 1x Voltage dependent resistor 3Watt Philips No. 2322-555-01161
- 1x 20K Ω Variable resistor.

5. APPLICATIONS (continued)

5.3 METHODS OF OBTAINING FREQUENCY SWEEP IN CONJUNCTION WITH AN OSCILLOSCOPE TO VIEW THE RESPONSE OF VARIOUS CIRCUITS: (Cont'd)

(b) Logarithmic Frequency Sweep (continued)

The components are connected to the unit as shown below:-

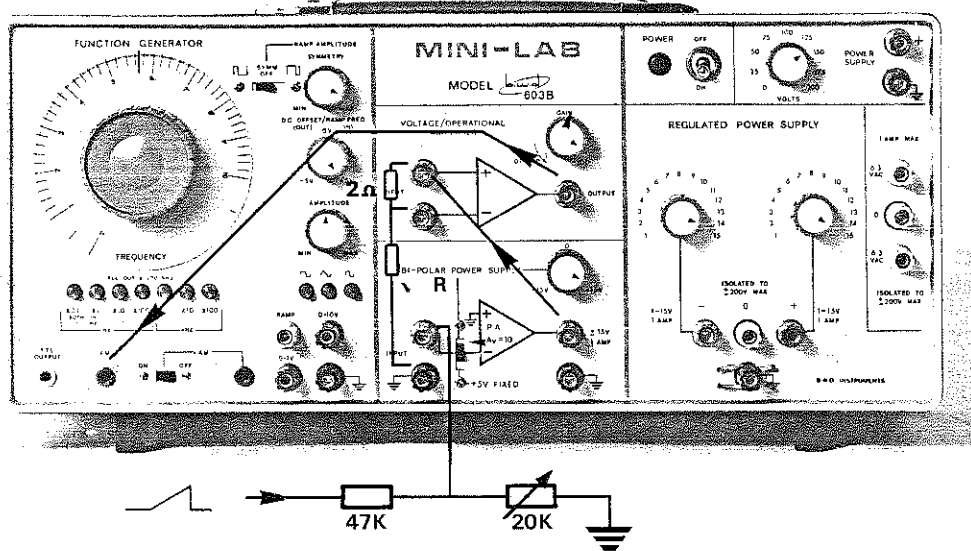

The gain of the Voltage Amplifier is varied to either increase or decrease the starting slope of the output waveform. When the desired shape is achieved the $20\text{K}\Omega$ variable resistor should be adjusted to give the required amplitude of modulating signal.

If the oscilloscope sweep output does not start at zero volts it may be necessary to add a compensating voltage into the Power Amplifier input to correct the D.C. level.

Due to the non-linear nature of the modulating signal it is very difficult to obtain any form of calibration. Hence the logarithmic sweep would normally only be used for visual inspection prior to a more accurate analysis.

5.4 USE OF AMPLIFIERS IN A SIMPLE RADIO RECEIVER:

This experiment shows how the two amplifiers of Model BWD 603B can be connected to form a high gain power amplifier capable of amplifying the small signals picked up and de-modulated by a simple tuned circuit and diode circuit.

5. APPLICATIONS (continued)

5.4 USE OF AMPLIFIERS IN A SIMPLE RADIO RECEIVER (Cont'd)

Equipment required:-

- (a) 1x Model BWD 603B Mini-Lab.
- (b) 1x Model BWD 600I Tuned Circuit.
- (c) 1x Model BWD 600N Loudspeaker.
- (d) Various leads.

Connect the equipment as shown below:

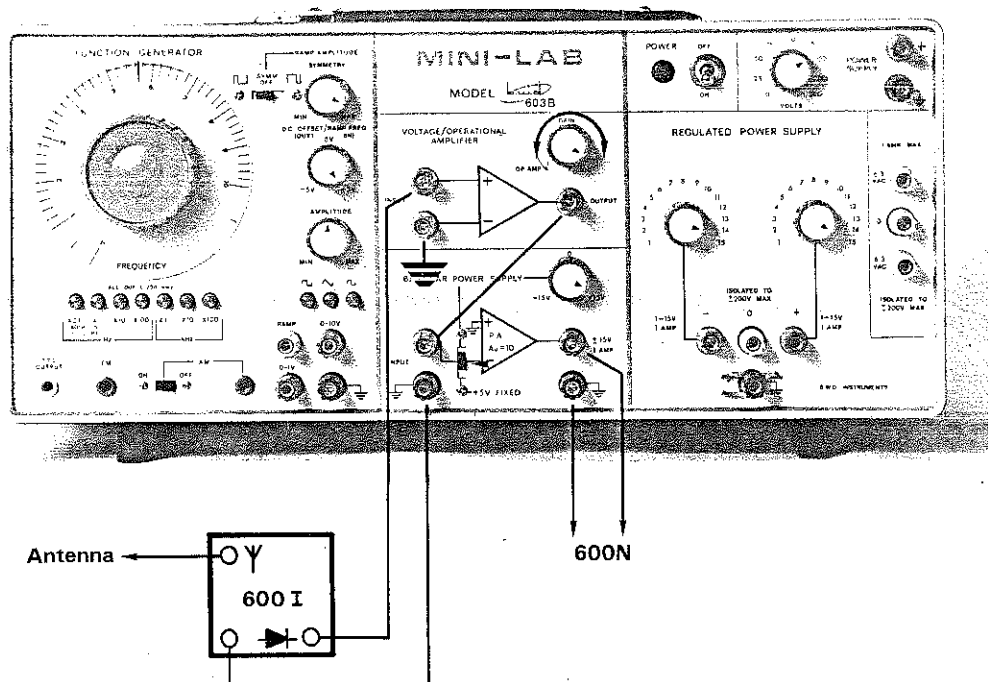

by adjusting the variable capacitor on the tuned circuit different broadcast radio stations can be heard.

5.5 USE OF AMPLIFIERS IN A SIMPLE PUBLIC ADDRESS SYSTEM:

Using the same amplifier configuration as in Section 5.4, but connecting a microphone into the input of the Voltage Amplifier shows the general method of producing a Public Address System.

Equipment required:

- (a) 1x Model BWD 603B Mini-Lab.
- (b) 1x Model BWD 600D Microphone.
- (c) 1x Model BWD 600N Loudspeaker.
- (d) Various leads.

5. APPLICATIONS (continued)

5.5 USE OF AMPLIFIERS IN A SIMPLE PUBLIC ADDRESS SYSTEM (Cont'd)

Connect the equipment as shown below:-

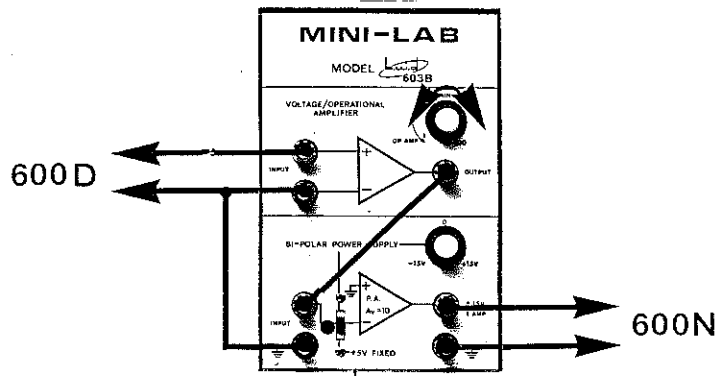

The Voltage Amplifier gain control can be used as a 'Volume Control'.

5.6 WIEN BRIDGE OSCILLATOR USING THE OPERATIONAL AMPLIFIER:

Positive feedback applied to an operational amplifier will generally cause the amplifier to oscillate. If the feedback network is arranged in such a way as to apply positive feedback at one frequency only, the amplifier will oscillate at that frequency.

The frequency where the phase shift is 0° is given by:-

$$f = \frac{1}{2\pi RC}$$

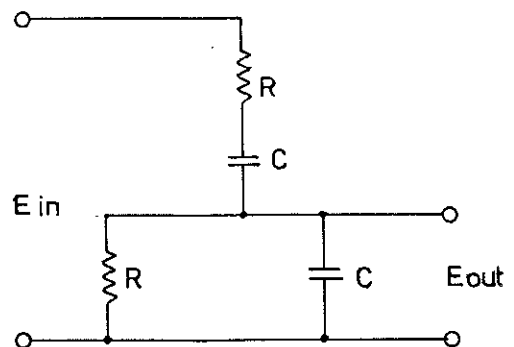

5. APPLICATIONS (continued)

5.6 WIEN BRIDGE OSCILLATOR USING THE OPERATIONAL AMPLIFIER (Cont'd)

The Wien Bridge network is applied to the operational amplifier in the following way:-

- R = 10K
- RF = 1K
- C = 0.1 μF

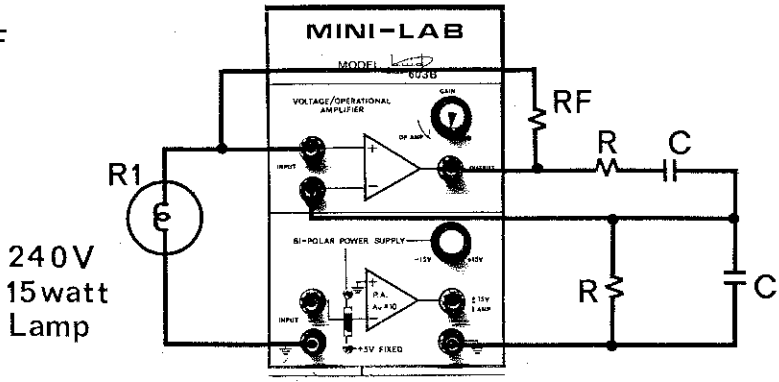

The 240V 15 Watt Lamp and RF function as an automatic level control, RF providing negative feedback and the resistance of the lamp - R1 - controlling the amount of negative feedback.

The gain of the amplifier is given by:-

$$(AV) = 1 + \frac{RF}{R1}$$

As the output of the oscillator rises the voltage across the lamp rises causing its resistance to increase. From the equation above it can be seen that as R1 increases (AV) decreases. Since the gain of the amplifier decreases, the output will decrease until the amplifier gain is just sufficient to maintain oscillations.

The output amplitude will be approximately 8V pp at a frequency of 160Hz.

5.7 A COMPARATOR USING THE OPERATIONAL AMPLIFIER:

The function of a comparator is to determine whether an input voltage is either greater than or less than a fixed reference voltage and provide a two level output, one level for $E_{in} < E_{ref}$ the other level for $E_{in} > E_{ref}$.

5. APPLICATIONS (continued)

5.7 A COMPARATOR USING THE OPERATIONAL AMPLIFIER (Cont'd)

Connect the operational amplifier as shown below:-

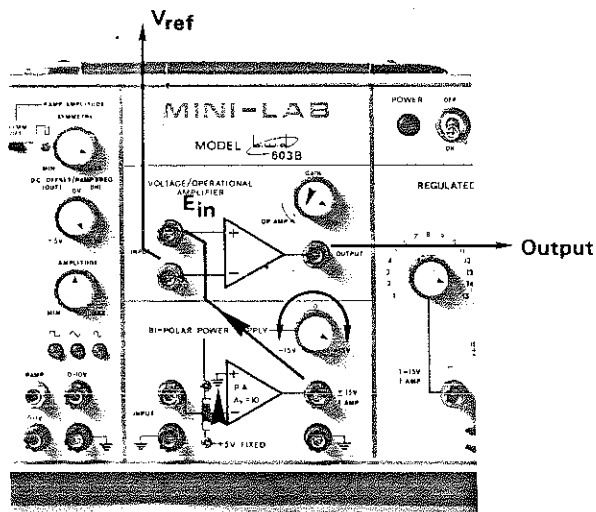

Note: V_{ref} can be obtained from the Function Generator by turning the Amplitude control to zero and using the D.C. offset to provide a $\pm 5V$ D.C. output at the 0-10V terminal.

Vary the output of the Bi-Polar Power Supply and simultaneously monitor the output of the Operational Amplifier. It can be seen that if the value of E_{in} is less than V_{ref} the output will be *negative*, and if E_{in} is greater than V_{ref} the output will be *positive*. The value of V_{ref} can lie anywhere between $\pm 10V$.

E_{in} and V_{ref} can be reversed resulting in polarity reversal of E_o .

5.8 A SCHMITT TRIGGER USING THE OPERATIONAL AMPLIFIER:

The operation of a Schmitt Trigger is similar to that of a comparator except that V_{ref} is derived from the value of E_o .

Connect the Operational Amplifier as shown below:-

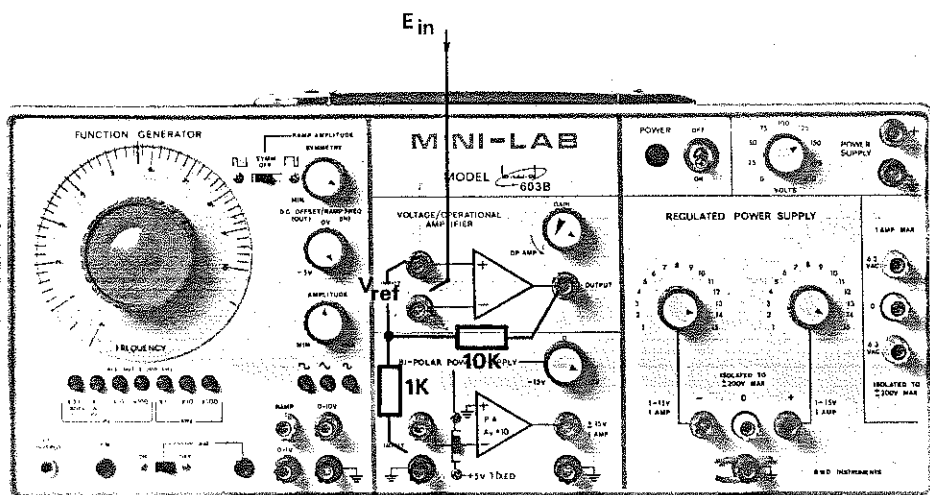

5. APPLICATIONS (continued)

5.8 A SCHMITT TRIGGER USING THE OPERATIONAL AMPLIFIER (Cont'd)

The value of the reference voltage is determined by the saturation voltage E_o and the voltage divider connected to the positive input. For the values shown, V_{ref} will be approximately $+1.5V$ or $-1.5V$.

The action of the circuit is as follows.

Let the input signal be $+5V$ thus making the output saturate at $-15V$. V_{ref} will now be approximately $-1.5V$. Decrease the input to a value more negative than $-1.5V$. The output will change to $+15V$. The input signal must now be increased to greater than the new reference voltage, which is $+1.5V$, before the output will return to the original $-15V$.

The difference between the two values of input signal required to change the output polarity is known as HYSTERSIS.

Variation of the voltage divider values will result in different values of HYSTERSIS.

5.9 ADDING THE POWER SUPPLIES IN SERIES TO PRODUCE HIGHER VOLTAGE RANGES:

Since the $-1 \rightarrow -15$ and $+1 \rightarrow +15V$ supplies are not connected to the instrument ground (FLOATING) they may be added in series with the output of the Bi-Polar Power Supply thereby increasing the total output voltage. The three methods of connecting the Bi-Polar Power Supply output are shown below and the voltage ranges are detailed after the diagram.

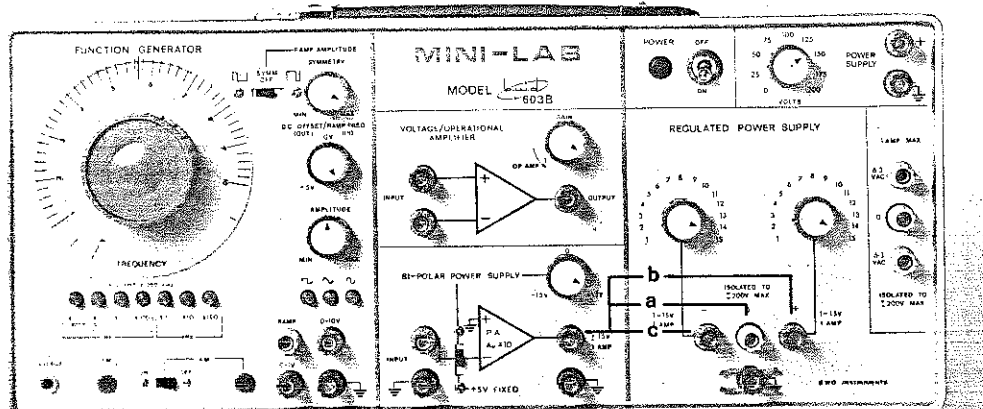

i. APPLICATIONS: (continued)

5.9 ADDING THE POWER SUPPLIES IN SERIES TO PRODUCE HIGHER VOLTAGE RANGES (Cont'd)

- (a) Bi-Polar Power Supply to the common terminal.
The total voltage range available at the +1 → +15V terminal is -14V to +30V.
The total voltage range available at the -1 → -15V terminal is +14V to -30V.
- (b) Bi-Polar Power Supply to the +1 → +15V terminal.
The total voltage range available at the -1 → -15V terminal is +13V to -45V.
The total voltage range available at the common terminal is +14V to -30V.
- (c) Bi-Polar Power Supply to the -1 → -15V terminal.
The total voltage range available at the +1 → +15V terminal is -13V to +45V.
The total voltage range available at the common terminal is -14V to +30V.

5.10 SUPERIMPOSITION OF A.C. SIGNALS ON A D.C. POWER SOURCE:

Using the connections given in Section 5 - 9 but switching the Bi-Polar Power Supply to Power Amplifier and driving the input of the Power Amplifier with the Function Generator provides a wide range of A.C. signals which can be superimposed on the D.C. power supplies.

The A.C. signals can be used to simulate ripple signals or switching pulses on power lines.

5.11 MISCELLANEOUS WAVEFORMS USING SYMMETRY CONTROL:

By using the symmetry control the Sine, Square and Triangular waveforms can be changed into the following:-

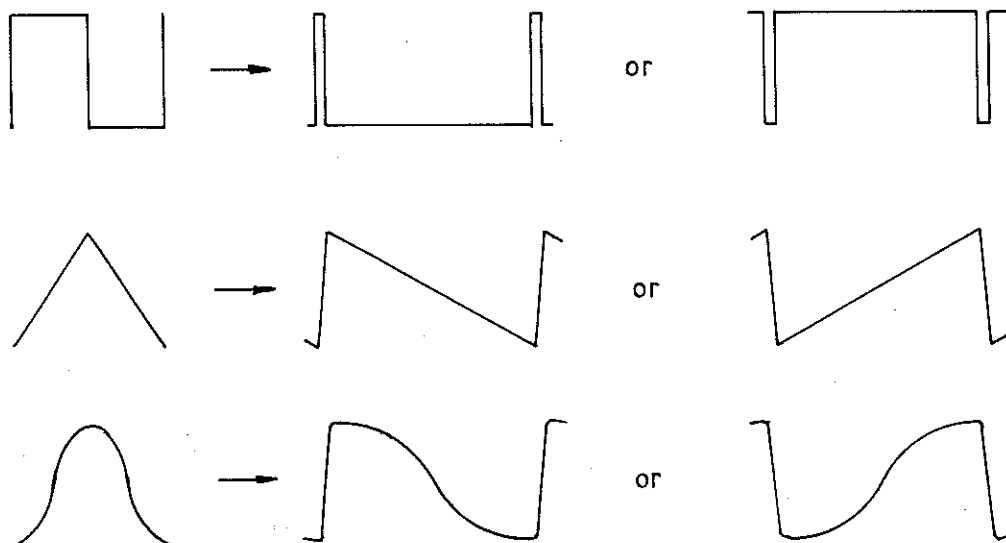

5. APPLICATIONS (continued)

5.12 MISCELLANEOUS WAVEFORMS BY CLIPPING:

When the Function Generator output is fed into the Voltage Amplifier, the following waveforms can be obtained by varying the amplitude of the input and the D.C. Offset control.

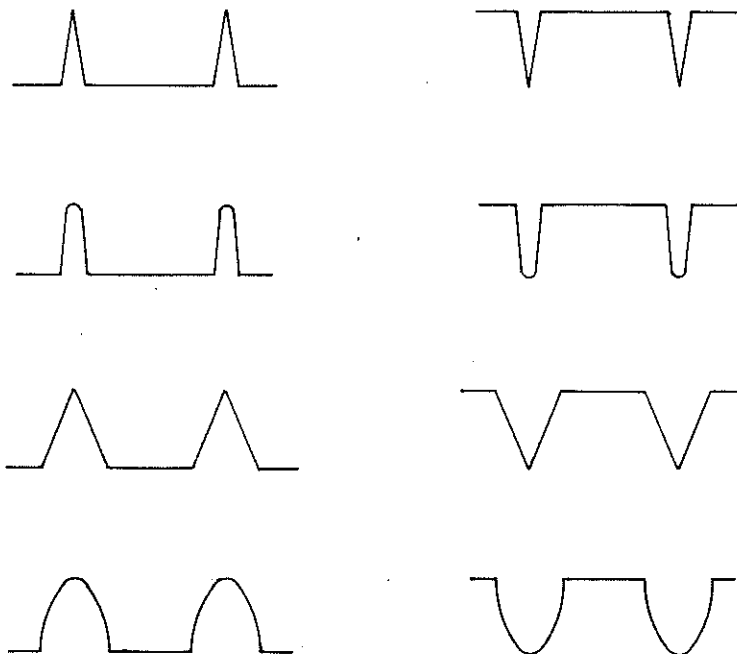

5.13 MISCELLANEOUS WAVEFORMS BY FREQUENCY MODULATING THE FUNCTION GENERATOR BY ITSELF:

- a. Connect the output (0-10V) terminal of the Function Generator to the F.M. input socket.
Set the output level to maximum clockwise and vary the DC Offset to produce the required waveform:

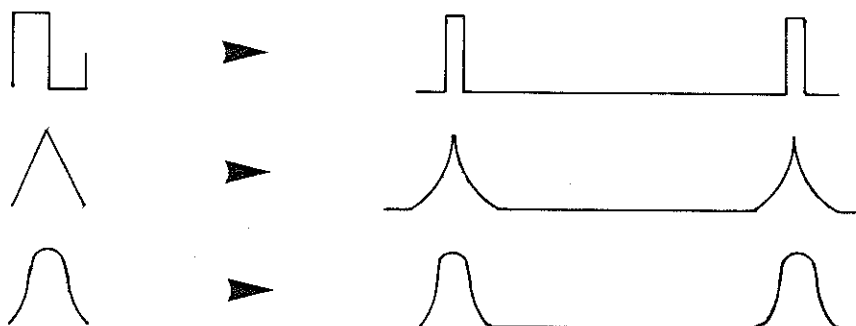

- b. Connect the Function Generator output (0-10V) to either the +ve or -ve input of the Voltage Amplifier.

5. APPLICATIONS (continued)

5.13 MISCELLANEOUS WAVEFORMS BY FREQUENCY MODULATING THE FUNCTION GENERATOR BY ITSELF: (Cont'd)

b. cont'd

Connect the Voltage Amplifier output to the F.M. input socket. No DC Offset is required.

The gain of the Voltage Amplifier is used to vary the waveforms, and inversion of the waveforms can be accomplished by reversal of the Voltage Amplifier input connections. The waveforms are as above.

5.14 MISCELLANEOUS WAVEFORMS PRODUCED BY AMPLITUDE MODULATION:

Connect the 6.3V AC terminal via a 39K Ω resistor to the A.M. input socket. Also connect the 0V A.C. terminal to any ground (\equiv) terminal. The frequency of the modulating signal is then equal to the mains frequency, i.e. 50 or 60Hz.

With the A.M. switched ON and the Function Generator frequency set to 1Hz, the following waveforms can be displayed:-

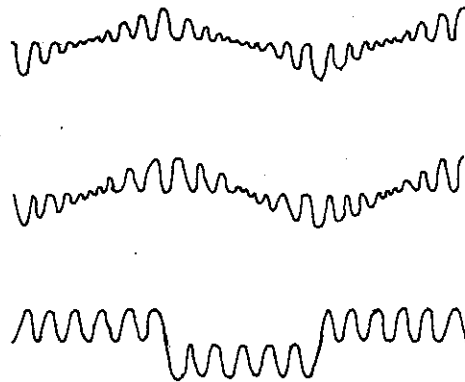

Reset the Function Generator frequency to 1kHz.

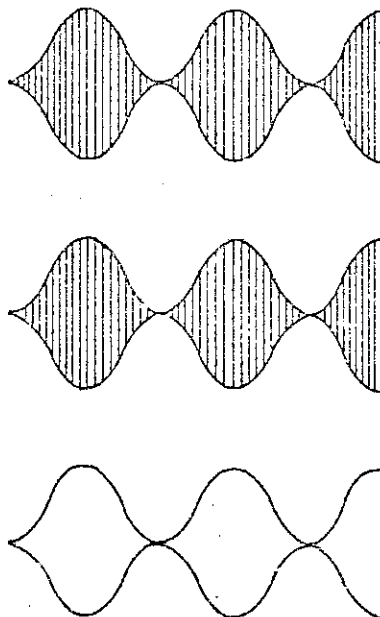

6. CIRCUIT DESCRIPTION:

6.1 The complete circuit of Model BWD 603B is divided into three discrete drawings. The numbers and contents are listed below:-

Drg. No. 1358	Triangle and Square Wave Generators, Sine Wave Shaper.
Drg. No. 1357	Amplitude Modulator, Output Amplifier, Ramp Generator, Variable 0-200V Power Supply.
Drg. No. 1355	Power Amplifier/Bi-Polar Power Supply/5V Supply Voltage/Operational Amplifier ±15V Regulated Variable Power Supplies Internal Power Supplies

The circuit description will be in the above order and for ease in finding any one Section, the Index below may be used:-

<u>SECTION</u>	<u>DESCRIPTION</u>	<u>PAGE</u>
6.2	Triangle and Square Wave Generators	6.0
6.3	TTL Output	6.2
6.4	Sine Wave Shaper	6.2
6.5	Amplitude Modulator	6.3
6.6	Output Amplifier	6.3
6.7	Ramp Generator	6.3
6.8	Variable 0-200V Power Supply	6.4
6.9	Power Amplifier/Bi-Polar Power Supply/5V Supply	6.4
6.10	Voltage/Operational Amplifier	6.4
6.11	+ and -15V Regulated, Variable Power Supplies	6.5
6.12	+ and -15V Regulated, Fixed Internal Supplies	6.5
6.13	Power Rectifiers and Filters	6.5

6.2 Triangle and Square Wave Generators: (Drg. No. 1358)

Both the triangle and square waves are generated simultaneously, the square wave being used to switch the current sources used to generate the triangle, and the triangle used via a comparator to produce a square wave. The block diagram on the next page shows the interconnection of the various parts.

6. CIRCUIT DESCRIPTION (continued)

6.2 Triangle and Square Wave Generators (Drg. No. 1358) (Cont'd)

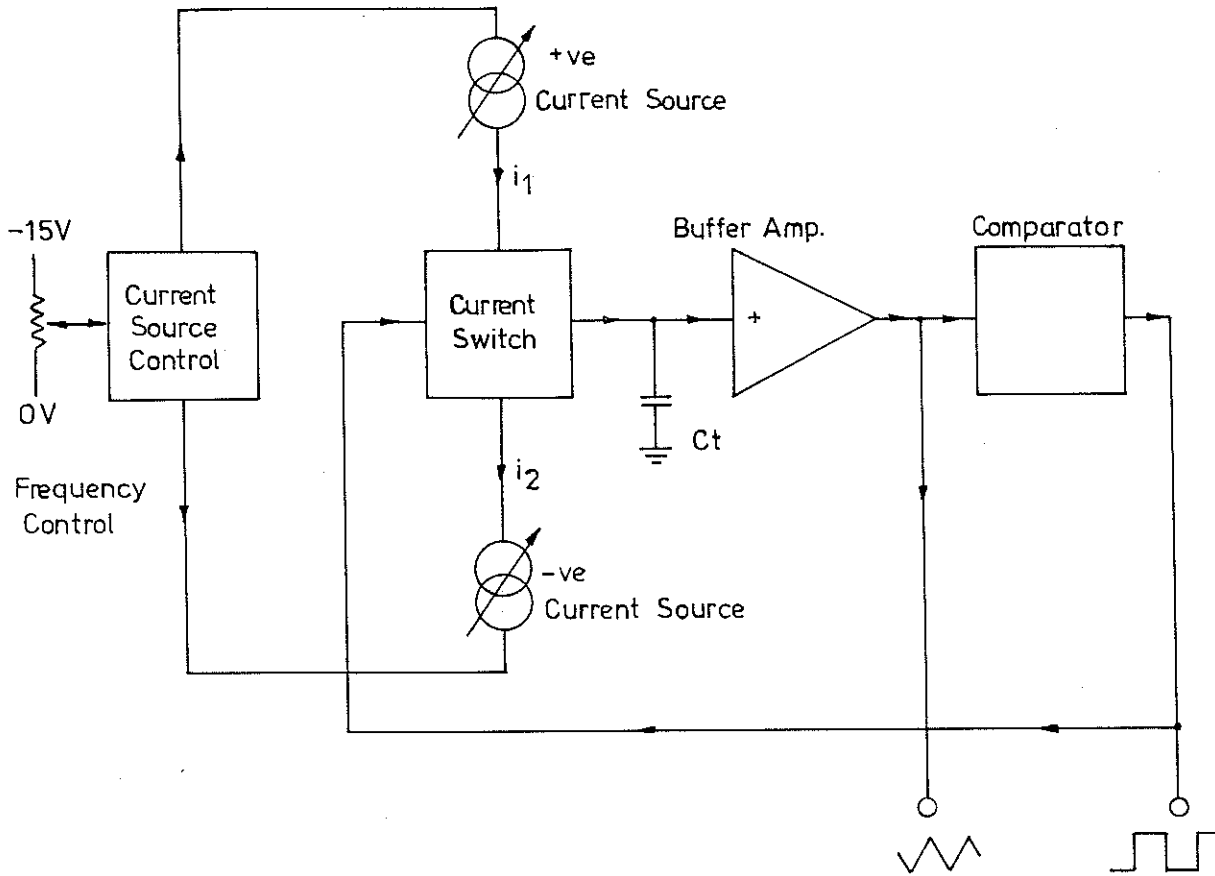

The variable voltage produced by the frequency vernier is amplified and inverted to produce two equal and opposite voltages which control the two current sources. The current switch passes either i_1 or i_2 to C_t the timing capacitor, producing a linear voltage ramp which is +ve going when i_1 is applied and -ve when i_2 is applied. The signal across C_t is passed through the buffer amplifier, which has a very high input impedance, to the comparator. Hysteresis of the comparator enables the input waveform to operate between +0.6V and -0.6V with switching occurring at + and -0.6V.

Assuming the comparator is switched in such a way as to allow the current switch to pass i_1 , the voltage across C_t rises positively, as does the output of the buffer amplifier. As the output of the buffer amplifier, and hence the comparator input, reaches +0.6V, the output of the comparator will change and via the current switch will remove i_1 , and substitute i_2 in its place. The voltage across C_t will now increase in a negative direction until the comparator input becomes -0.6V. The comparator output will change state and return the current switch to the initial state, passing i_1 , to C_t .

6. CIRCUIT DESCRIPTION (continued)

6.2 Triangle and Square Wave Generators (Drg. No. 1358) (Cont'd)

Looking at Circuit Drg. No. 1358, the current source control is derived in the following way:-

RV2, the Frequency Vernier produces at the -ve input of U1A a variable voltage. This voltage is inverted by U1A and becomes the input voltage for both U1B and U1C.

U1B voltage follower reproduces the input voltage at R115, whilst U1C, acting as an inverter with unity gain, reproduces an inverted replica of the input voltage at R118. Q2 and Q4 are the +ve and -ve current sources with their emitters fed by R115 and R118 respectively. Q1 and Q3 emitter followers produce fixed base voltages for Q2 and Q4, so that changes in control voltage via U1B and U1C produce a change in current through R115 and R118, and hence a change in current from the collectors of Q2 and Q4. D104, D105, D106 and D107 form the current switch, steering either one or the other current to the timing capacitors C14, C16, C23 and C102-110.

The frequency range switch S3 to S9 selects the particular capacitor required, with S3B and S4B together selecting the low frequency range (X0.01Hz) capacitors C109 and C110. The FET follower, U5, has a high input impedance and a low output impedance. The Triangle output is taken from this point via a buffer amplifier comprising Q5, 6, 9.

Integrated circuit U2 functions as the comparator, with its output taken to the current switch via emitter follower Q8, with diodes D115 and D116 for level shifting.

Hysteresis of the comparator is caused by feeding back a portion of the output signal to pin 5. The output of the comparator is clipped by D117 and D118 to produce a $\pm 0.6V$ square wave which is used as the comparator reference. The comparator output is also clipped by D119 and D120 to produce the square wave output. Because of its fast rise time, portion of the switching signal capacitively bypasses the current switch. This is compensated by applying an equal and opposite signal via C24.

6.3 T.T.L. Output: (Drg. No. 1358)

The inverted output of the Comparator is taken via R121 to Q7 base. Q7 amplifies the square wave and provides a 0V to +5V output at its collector.

6.4 Sine Wave Shaper: (Drg. No. 1358)

Because of its S-shaped transfer characteristic, U100 converts the triangle input to a sine wave output. RV103 adjusts the symmetry of the resultant sine wave, while RV106 adjusts the degree of flattening of the peaks. RV107 allows the DC level to be set to zero, and RV109 adjusts the output amplitude.

6. CIRCUIT DESCRIPTION (continued)

6.5 Amplitude Modulator: (Drg. No. 1357)

U101 is connected as a variable gain amplifier. The carrier input is taken via buffer U105 to Pins 3 and 6. The modulating signal is taken via RV112 and U106 to Pin 2. The output appears at Pin 1, is DC level shifted by RV102, and then taken via amplifier U108 to switch S103b.

6.6 Function Generator Output Amplifier: (Drg. No. 1357)

The required input waveform is selected by S100, S101 and S102. S103A and B redirect the signal through the amplitude modulator when required.

RV110 Output amplitude control adjusts the input to U501, the output of which is fed to Q100 base. The output appearing at the collectors of Q102 and Q103 is fed back to the base of Q101 via R506, providing negative feedback and a gain of approximately 20.

DC offset is taken from RV104 via S104 and R505 to the base of Q101.

6.7 Ramp Generator: (Drg. No. 1357)

C402 is alternately charged and discharged by:-

- a. The constant current source provided by Q401 and U401A.
and
- b. The negative going output of U401B via R404 and D401.

Assume the output of U401B is positive (approx. +10V). U401B functions as a comparator allowing C402 to charge from the constant current source to a DC level of approximately +0.6V. At this point the voltage across C402 (and therefore U402 output) becomes slightly greater than the voltage at the NON-INV input of U401B whose output switches to -10V, and via R404 and D401 discharges C402 to zero volts in approximately 5mSec. The NON-INV input of U401B falls to zero volts, so that when the voltage across C402 reaches zero, U401B switches to a positive output, allowing C402 to charge from the constant current source.

U401A is wired as a unity gain amplifier, providing low loading of the frequency control (which also functions as a DC offset control for the Function Generator).

U401D is the output amplifier with RV401 providing variable gain, and hence an output voltage control. U401C senses when the output frequency of the Function Generator exceeds its upper limit for whatever range is selected. When this occurs it resets the Ramp to zero volts via U401B, as described above.

This circuit prevents ambiguous frequency sweep operation when the Ramp attempts to produce a higher frequency than the Function Generator will allow.

6. CIRCUIT DESCRIPTION (continued)

6.8 Variable 0-200V Power Supply: (Drg. No. 1357)

The series pass transistors, Q206, Q207 control the output. Transistor Q204 senses the output (via divider network RV7, RV204 and R246) and corrects for changes via driver Q208 and bases of Q206, Q207. As the output current reaches approximately 40ma the voltage across R243, and hence the base/emitter junction of Q205, reaches approximately 0.6V, and Q205 starts to conduct, taking base current away from Q208. The current limiting commences at approximately 40ma and terminates at approximately 50ma into a short circuit load.

6.9 Power Amplifer/Bi-Polar Power Supply/5V Supply: (Drg. No. 1355)

The input is taken via S200A and B and R201 to Operational Amplifier U200. The output of U200 is further amplified to produce a high power output at the junction of the collectors of Q202 and Q203. To maintain the gain of 10, negative feedback is applied via R202 to one of the inputs of U200. C201 limits the overall frequency response, whilst C202 adjusts the HF response of the power stage only. Automatic overload protection is provided by R214, D202, D203, D209 in the positive direction, and R215, D204 and D205 in the negative direction. Input protection is achieved by D206 and D218.

When the amplifier is used as a Power Amp., the input is taken through S200A to R201.

When used as a Bi-Polar Power Supply, the input is taken to RV200 via R200 which provides, at R201, a DC level adjustable to $\pm 1.5V$. When amplified by 10 the output produces a $\pm 15V$ swing.

When used as a +5V fixed supply, S200A open circuits the INV input and S200B connects the NON-INV input via R217, R229 to the +15V rail. R217, R229 and R203 form a voltage divider.

6.10 Voltage/Operational Amplifier: (Drg. No. 1355)

S201A and B in the position shown ground the +ve input via R220 and apply negative feedback to the -ve input via R223, R224, RV201 and C203. Variation of RV201 adjusts the amount of signal to R223 and hence the gain of the amplifier. In this 'Voltage Amplifier' mode, the input impedance is set by R221 and R222 and the gain is adjustable from 1 to 100.

When S201A and B are open circuit, the integrated circuit operational amplifier is connected directly to the input and output terminals without negative feedback. The 'Voltage Amplifier' has now been connected to form an 'Operational Amplifier' with an open loop gain of better than 100db. See Section 2, paragraph 15 for more details.

6. CIRCUIT DESCRIPTION (continued)

6.11 +ve and -ve 15V Regulated Variable Power Supplies: (Drg. No. 1355)

Both the +ve and -ve supplies use an integrated circuit 3-terminal adjustable regulator; U300 for the +ve supply and U301 for the -ve supply. Adjustment of the output voltage is provided by RV301 (+ve) or RV303 (-ve) with RV300 setting the maximum +ve voltage and RV302 setting the maximum -ve voltage. Since both regulators are in the positive line the two supplies are independent, being connected together only at the output terminal.

6.12 +ve and -ve 15V Regulated Fixed Power Supplies: (Drg. No. 1355)

U303 and U302, 3 terminal regulators set the + and -15V supply rails. RV320 adjusts the output of U303 to give +15V, and RV321 adjusts the output of U302 to give -15V.

6.13 Power Rectifiers and Filters:

The rectifiers and filter capacitors together with the circuits they power are listed below:-

	<u>Rectifiers</u>	<u>Filter</u>
a. Variable +1 to +15V	D300, D301, D302, D303	C300
b. Variable -1 to -15V	D304 D305 D306 D307	C301
c. Fixed + and -15V	D312 D313 D314 D315	C310 (+ve) C311 (-ve)
d. Variable 0 - 200V	D320 D321	C320 C321

7. ALIGNMENT

Component changes will not normally affect the performance of the unit, subject to the replacement component being of similar size, stability and performance to the original component.

7.1 Test Instruments Required:

<u>TYPE</u>	<u>CHARACTERISTICS</u>	<u>USE</u>
Multimeter	AC and DC Voltage to >250V DC Ampere to >2A	Voltage and current measurement.
AC Millivoltmeter	Sensitivity 5mV FSD and 50mV FSD Frequency Range to >50MHz	Ripple and noise measurement.
Oscilloscope	"Y" Bandwidth DC-20MHz "Y" Sensitivity 10mV to >10V/cm AC and DC coupled	Viewing of various waveforms - p-p measurements.
Digital Frequency Meter	Frequency Range 10Hz to >2MHz	Frequency measurement.
Distortion Analyser	Frequency Range >10Hz -50kHz	Sine distortion measurement.

7.2 General Procedure:

The order of adjustments described in this Section has been determined so that any adjustment will not affect a previous adjustment. RV320 and RV321, however, should be checked before any other adjustments are carried out, since the fixed $\pm 15V$ rails are used throughout the unit and should they be outside the tolerances given, difficulty may be experienced. The following Table shows the possible interactions of the various controls. Adjustment of a preset in Column A will affect only the preset opposite an 'X' in Column B.

For location of presets see Section 7.21 for P.C.B. layout drawings.

Allow 15 minutes' warm up time before calibration.

7. ALIGNMENT: (continued)

7.2

	RV1	RV3	RV5	RV6	RV101	RV102	RV103	RV106	RV107	RV108	RV109	RV111	RV112	RV202	RV203	RV204	RV300	RV8	RV320	RV321	C14	C16	C23	C24	B
RV1	X																								
RV3	X	X																							
RV5	X	X																							
RV6				X	X	X	X	X	X		X	X	X					X							
RV101					X						X	X													
RV102																									
RV103							X	X			X														
RV106							X		X		X														
RV107								X			X														
RV108				X	X				X																
RV109																									
RV111					X	X							X												
RV112																									
RV202																									
RV203																									
RV204																									
RV300																									
RV8				X																					
RV320	X	X	X	X	X	X	X	X	X	X	X	X	X	X	X	X					X	X	X		
RV321	X	X	X	X	X	X	X	X	X	X	X	X	X	X	X	X					X	X	X		
C14																									
C16																						X			
C23																						X	X		
C24																						X	X	X	

A

7.3 RV320 Set +15V Fixed Supply:

Connect the voltmeter between earth and +15V on the Function Generator board (PCB No. 160/266G). Adjust RV320 to give +15.0V indication on meter.

7.4 RV321 Set -15V Fixed Supply:

Connect the voltmeter between earth and -15V on the Function Generator board (PCB No. 160/266G). Adjust RV321 to give -15.0V indication on meter.

7. ALIGNMENT: (continued)

7.5 RV1 Set Maximum Frequency:

Centralise RV5 and set the Function Generator controls as shown below:-

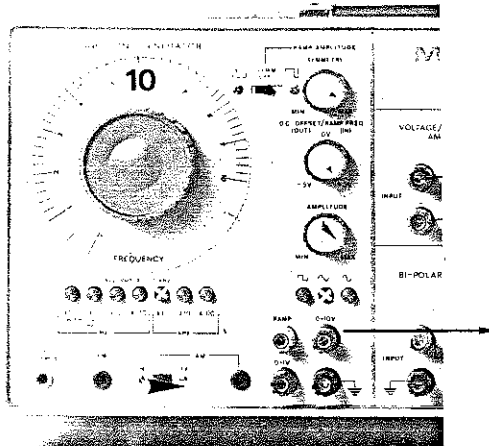

The frequency meter is connected to the output terminals, and RV1 is adjusted to give 10kHz output.

7.6 RV3 Set Minimum Frequency:

With the controls set as in 7.5, adjust the frequency vernier to 1.0. RV3 is adjusted to give 1kHz output. Reset RV1 and then check RV3. Since these preset controls interact with one another, it may be necessary to adjust both RV1 and RV3 several times.

7.7 RV5 Set 1:1 Symmetry:

This control sets the fixed symmetry at the lower frequency end of the dial.

Set the controls as in 7.5 with the frequency vernier set to 0.1. Connect the oscilloscope to the Function Generator Output Terminals. RV5 is set to produce a triangle where positive and negative peaks are spaced equally apart.

Repeat Sections 7.5, 7.6, 7.7 as some interaction may occur.

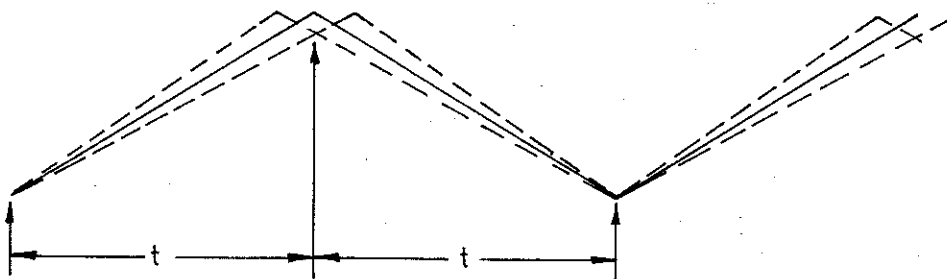

7. ALIGNMENT: (continued)

7.8 C24 Adjustment:

With controls set as shown below, connect an oscilloscope to the output terminals.

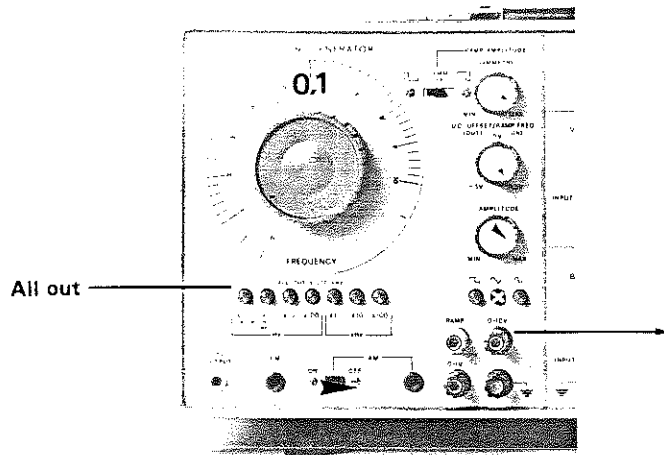

Adjust C24 to minimise switching transients, as shown below.

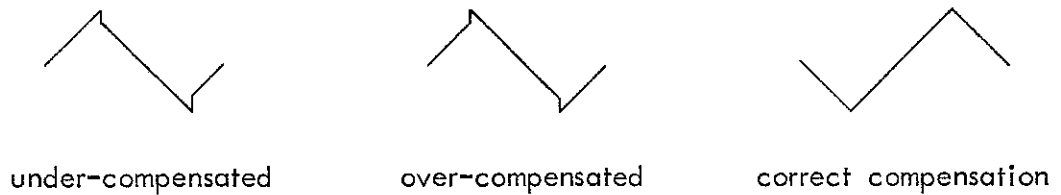

7.9 C23 Set 2.0MHz:

With the controls set as shown below (note all frequency range buttons OUT) and a frequency counter connected to the output, adjust C23 to give 2.00MHz output frequency. Refer to Section 7.2 for possible interactions.

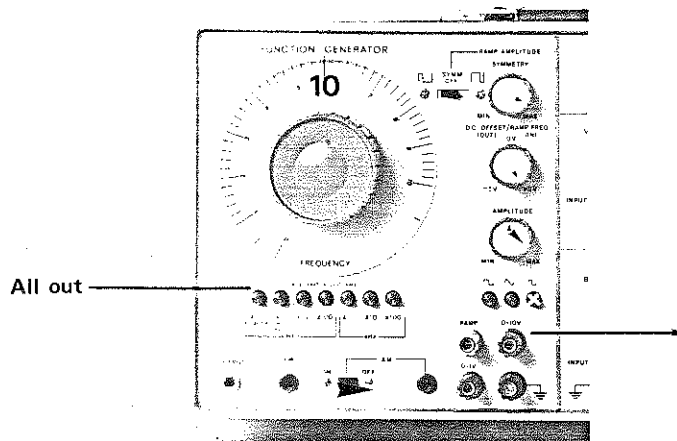

Repeat Section 7.8, then recheck Section 7.9.

7. ALIGNMENT: (continued)

7.10 C16 Set 1.0MHz:

With the controls set as shown below and a frequency counter connected to the output, adjust C16 to give 1.00MHz output frequency.

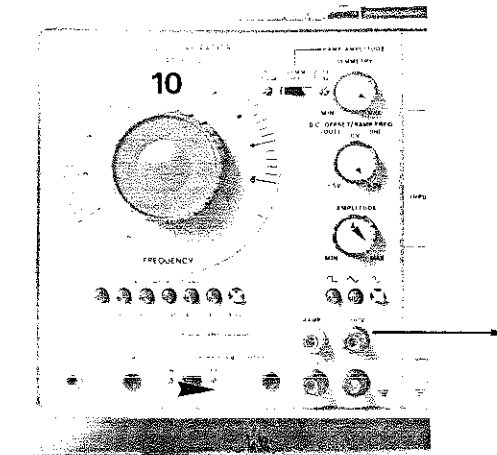

7.11 C14 Set 0.1MHz:

With the controls set as shown below and a frequency counter connected to the output, adjust C14 to give 0.100MHz output frequency.

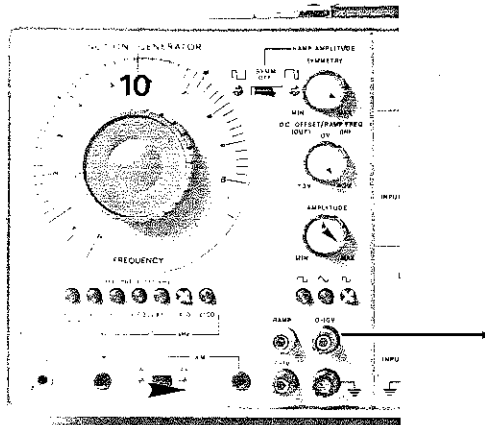

7.12 Output Amplifier Offset Adjustment:

Set the controls as follows:

All three waveform selector buttons OUT.

AM switch OFF.

Amplitude control on minimum.

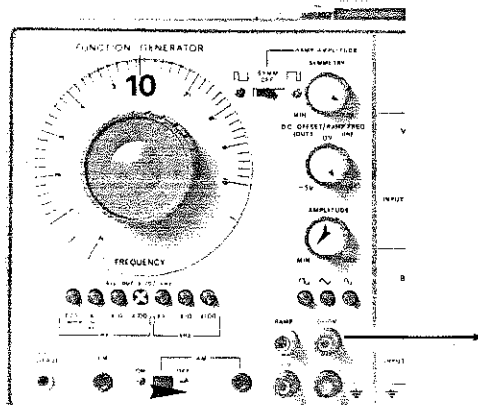

Adjust RV108 to obtain zero Volts ± 10 mV at main output terminals.

7. ALIGNMENT: (continued)

7.13 Triangle Buffer Amplifier Offset and High Frequency Offset Adjustments

- (a) Set controls as for Section 7.5.
Adjust amplitude control to obtain 600mV p-p triangle wave.
Adjust RV6 so that triangle waveform at output is perfectly symmetrical about zero.
- (b) Change frequency to 2MHz and adjust RV8 so that output waveform is symmetrical about zero.

Repeat (a) and (b).

7.14 Amplitude Modulator Adjustments:

Set controls as follows:-

All three waveform selector buttons OUT.

AM switch ON.

Amplitude control on 80% of maximum setting.

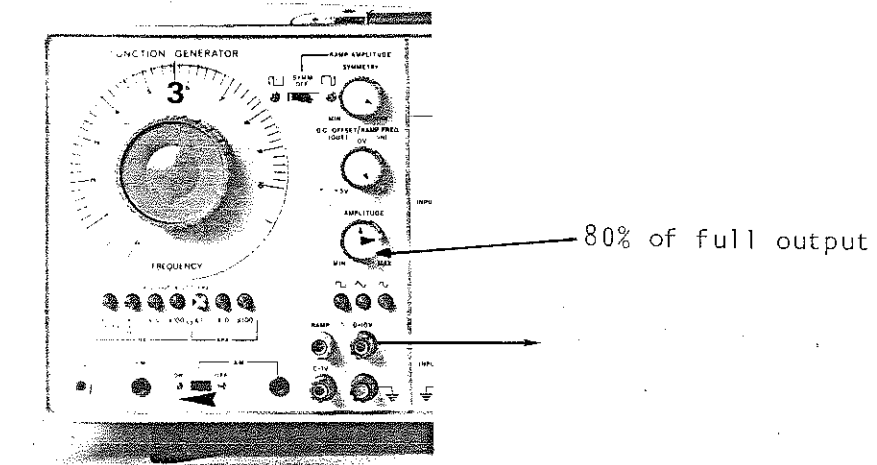

Monitor output with oscilloscope (500mV/cm DC coupled).

1. Set RV112 fully anticlockwise, and RV111 at one end of its travel.
2. Adjust RV102 for zero DC output.
3. Link 6.3V AC supply to earth and to AM input via a 39K resistor.
Change CRO to AC coupled.
4. Adjust RV111 for minimum output signal. Change CRO to DC coupled.
5. Adjust RV102 for Zero DC output.
6. Turn AM switch off and press triangle waveform button.
Remove input from AM socket.
Use symmetry switch and potentiometer to obtain an asymmetrical waveform (about 4 Volts p-p).

Adjust RV101 so that the output amplitude does not change when the AM switch is turned ON and OFF.

Note that this result can be obtained at two different settings of RV101.

The correct setting is the one which does NOT reverse the asymmetry of the waveform.

7. ALIGNMENT: (continued)

7.14 Amplitude Modulator Adjustments: cont'd.



Must not reverse

7. Turn symmetry switch OFF.
Turn AM switch ON.
Connect 39K from 6.3V to AM input terminal.
Adjust RV112 to obtain about 95% modulation.
 8. Adjust RV111 so that the positive and negative halves of the modulation envelope are symmetrical.
 9. Adjust RV102 to accurately zero the waveform.
- 8 and 9 interact, so repeat them several times.

7.15 Sine Wave Shaper Adjustments:

Set controls as shown below, and connect oscilloscope to main output terminals.

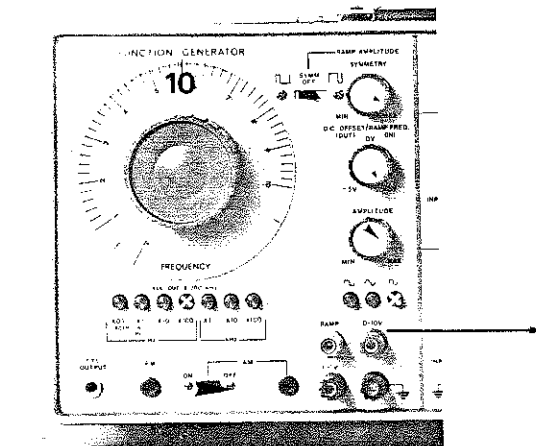

1. Adjust RV103 so that the wave is symmetrical.
 2. Adjust RV106 for correct degree of rounding.
- 1 and 2 interact, so repeat several times.
3. Adjust RV107 for zero DC output level.
 4. Adjust RV109 so that the sine wave amplitude is the same as the triangle wave amplitude.
- 3 and 4 interact, so repeat.

7. ALIGNMENT: (continued)

7.15 Sine Wave Shaper Adjustments: cont'd.

Connect distortion analyser to output terminals.

5. Adjust RV103 and RV106 for minimum distortion.
Repeat several times because of interaction between settings.
Distortion should be able to be reduced below 0.8% (0.5% typical).
6. Check 3 and 4.

7.16 RV202 Set X100 Gain (OP Amp):

Set the controls as shown below, and connect the input of the Amplifier as shown. Adjust the level at Point A to be 0.1V p-p. Measure the signal at Point B, and adjust RV202 to give 10V p-p.

From 0-1V Output
of Function Generator
 $f = 1\text{kHz}$ Sine Wave

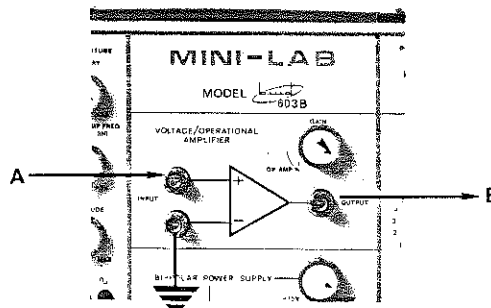

7.17 RV203 DC Offset (OP Amp):

Set the controls as shown below, and adjust RV203 to give zero Volts DC between the output terminal and ground (\equiv).

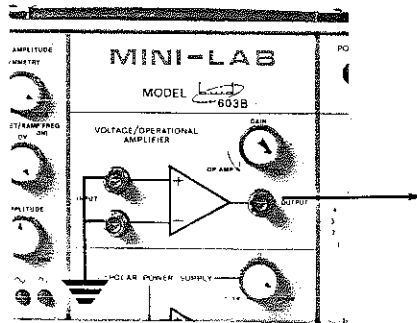

7.18 RV204 Set Maximum Voltage (0-200V):

Set the controls as shown below, and connect the voltmeter across the output terminals. RV204 is adjusted to give 200V (-0, +10V) across the output terminals.

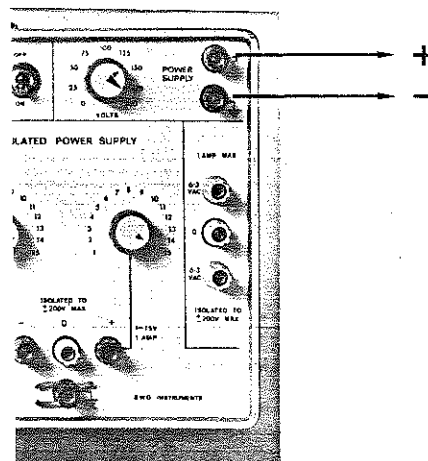

7. ALIGNMENT: (continued)

7.19 RV300 Set Maximum Voltage (+1 to +15V):

Set the controls as shown below, and connect the voltmeter across the output terminals.

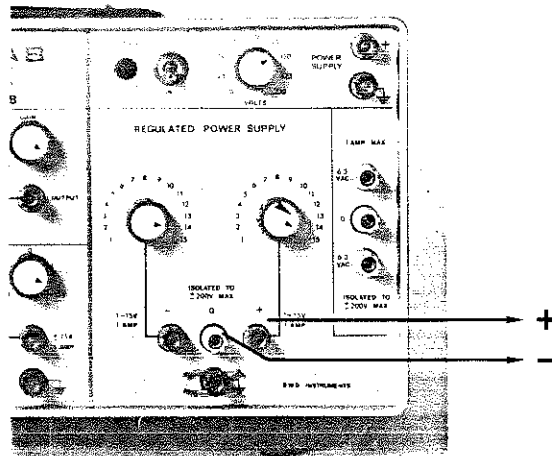

With the Output Voltage Control set to maximum clockwise, set RV300 to give approximately 16V output. Set the Output control to give +2V output and adjust the knob position on the shaft so that the pointer is opposite the "2" on the panel. Adjust the Output Voltage Control to indicate 15V and reset RV300 to provide 15V output. As a further check, several points on the calibration can be checked and RV300 set to give the best overall result.

7.20 RV302 Set Maximum Voltage (-1 to -15V):

Set the controls as shown below, and connect the voltmeter across the output terminals.

The same procedure for setting RV300 is used for RV302, ensuring that the correct Output Voltage Control is adjusted.

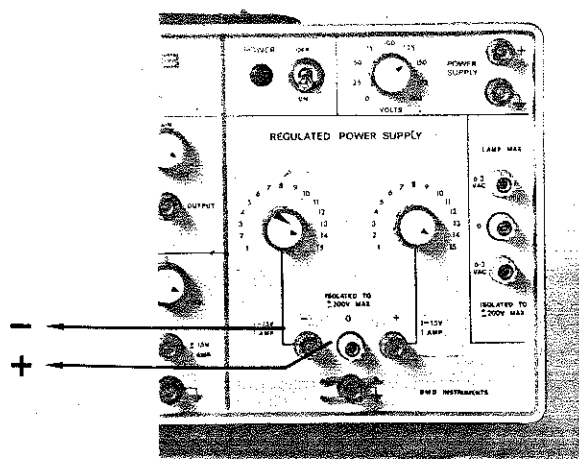

7. ALIGNMENT: (continued)

7.21

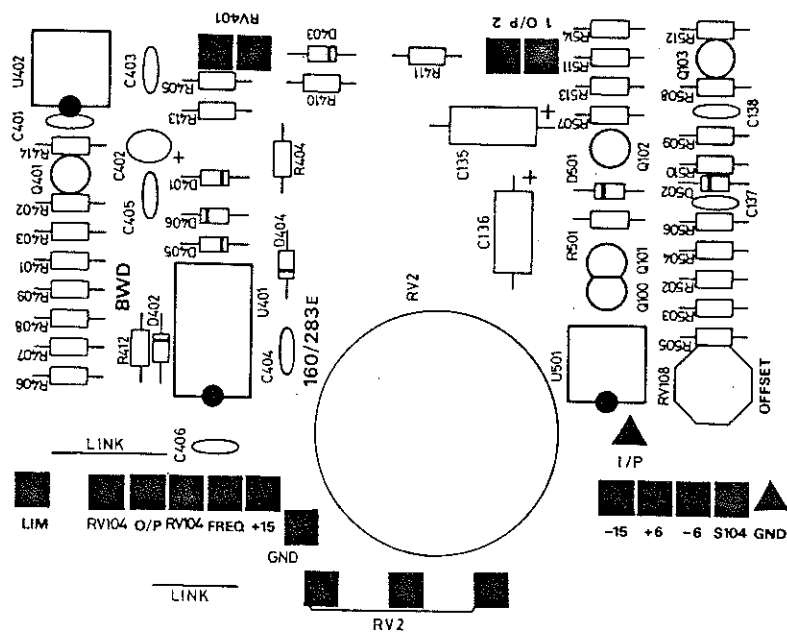

RAMP GENERATOR & OUTPUT AMP. PC BOARD

7. ALIGNMENT: (continued)

7.21

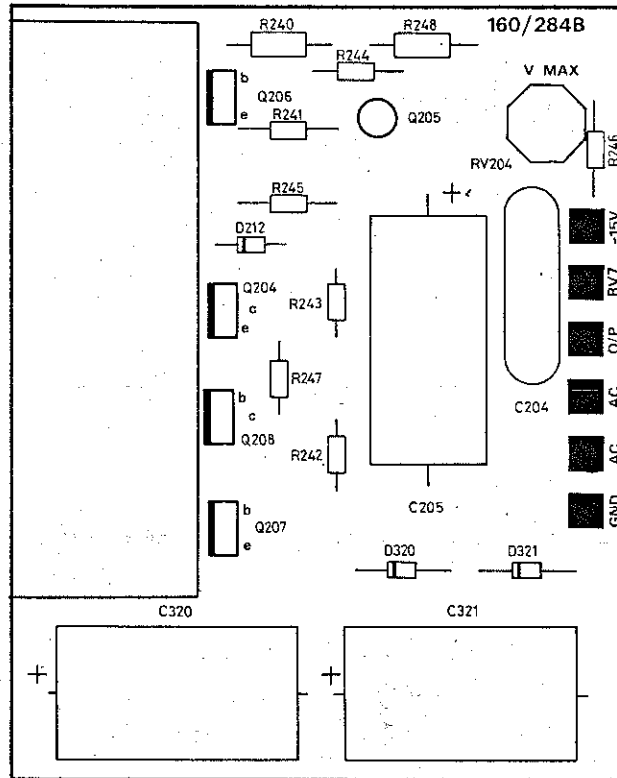

VARIABLE 200V SUPPLY PC BOARD

7. ALIGNMENT: (continued)

7.21

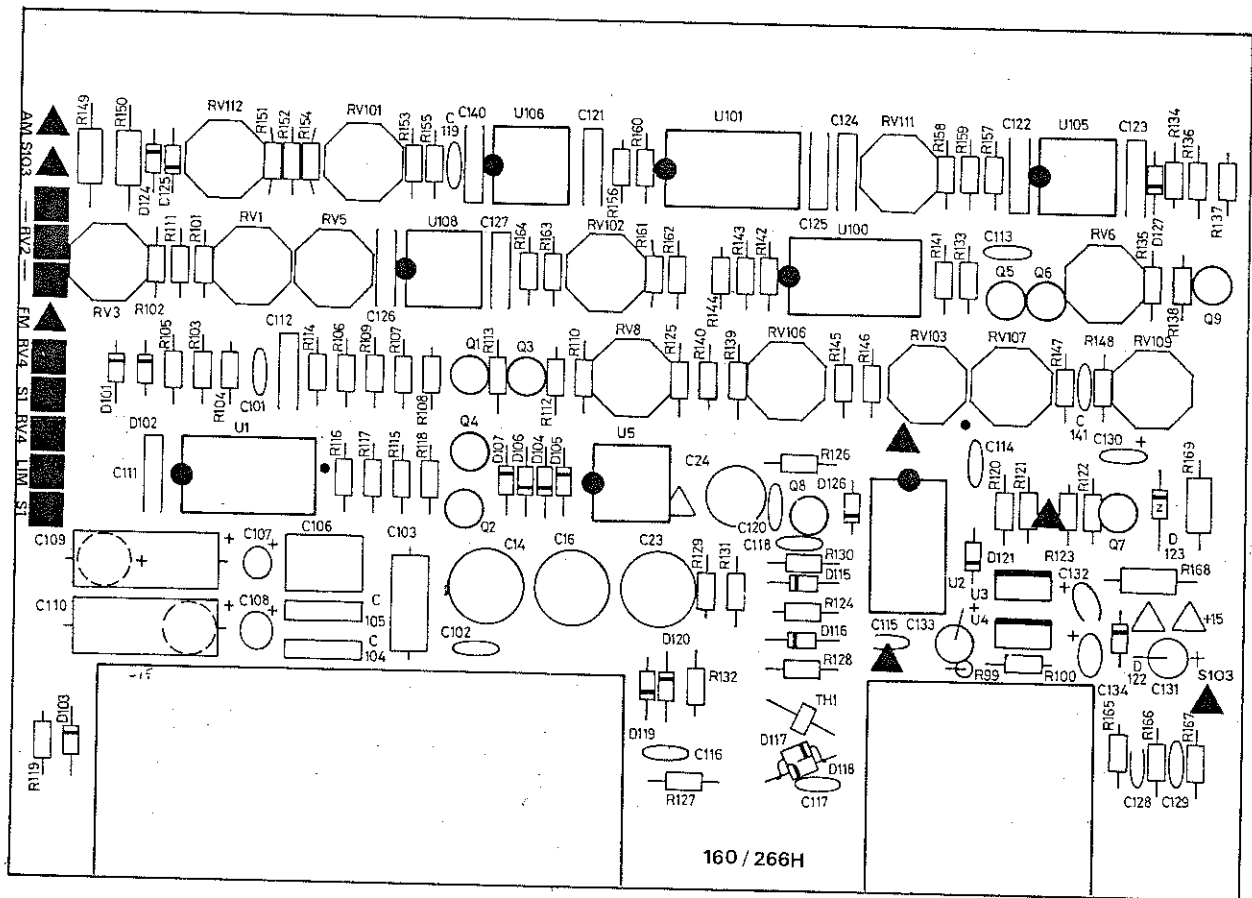

FUNCTION GENERATOR PC BOARD

7. ALIGNMENT: (continued)

7.21

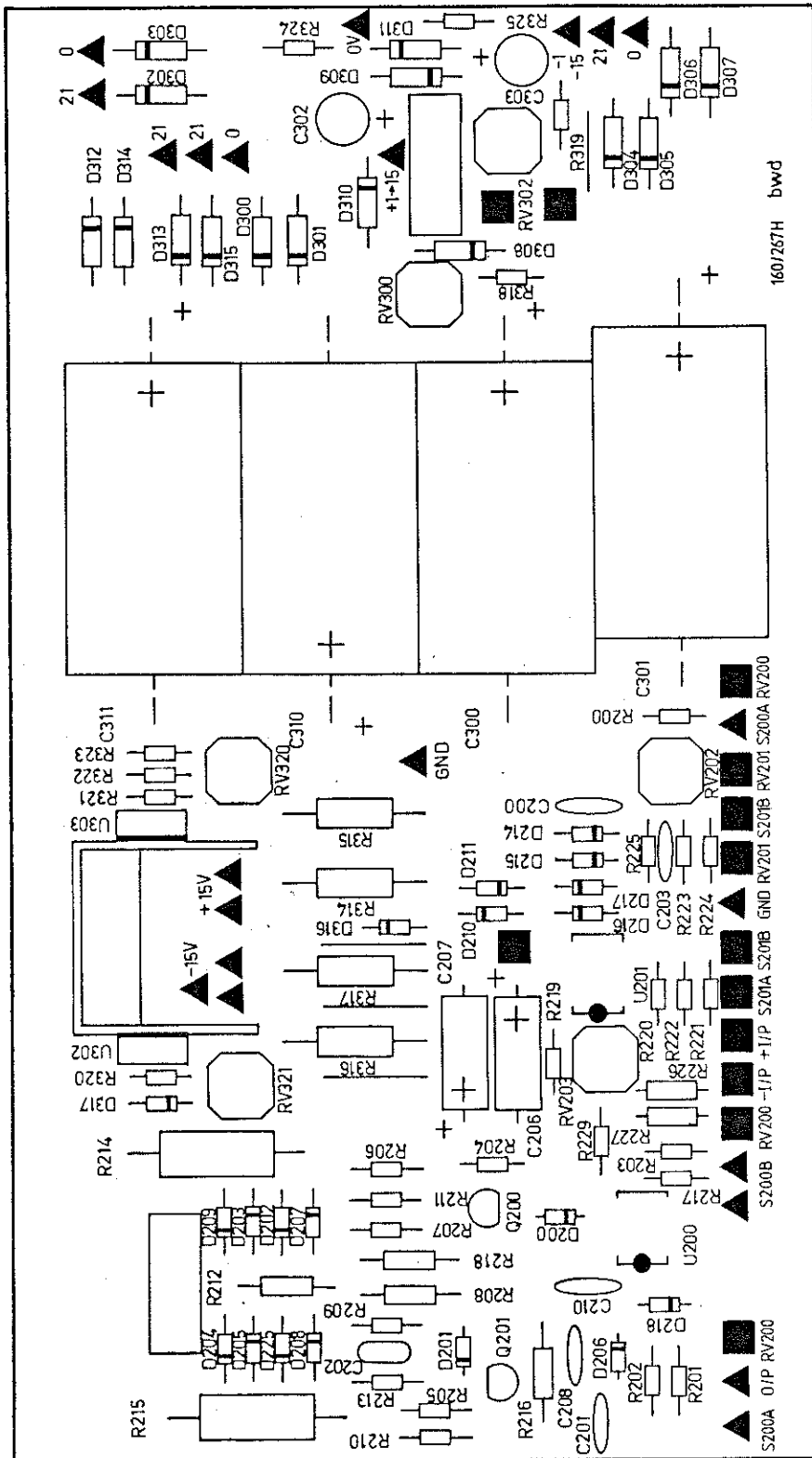

POWER SUPPLY PC BOARD

8. MAINTENANCE:

8.1 Removal of Covers:

a. Top Cover:

With the unit in a normal operating position, i.e. with all four feet resting on a horizontal flat surface, remove the two screws securing the chromed handle end plates. Also remove the two screws located near the jointing lines of the top and bottom covers. The top cover is now free to remove.

b. Bottom Cover:

With the unit inverted remove the four screws securing the plastic feet to the unit. If the top cover has not previously been removed, remove the two screws located near the jointing lines of the top and bottom covers. The bottom cover may now be removed.

NOTE:

Reassembly of the above items can be done in the reverse order.

8.2 Removal of Heatsinks:

a. The heatsinks are secured to the rear panel by two screws, the heads of which are visible from the rear of the unit. Before removing these screws, first remove the top cover (8.1(a)) and unplug the lead(s) from the heatsink that is to be removed.

b. The two securing screws may be removed and the heatsink will be free to move.

NOTE:

Reassembly of the heatsink can be done in the reverse order.

8.3 Semiconductor Replacement:

Before removing any transistors or diodes from the unit, the device should be labelled so that in the event a defective device is found, its circuit location may be identified thus isolating the source of trouble.

8.4 Removal of Integrated Circuits:

Extreme care must be exercised in removing integrated circuits from the unit. Since all the I.C.'s are inserted in sockets a standard I.C. removal tool is recommended. However, if such a tool is not available the I.C. should be carefully pulled from its socket in such a way as not to bend or distort its pins. Similarly replacement should take place with due care ensuring that all the leads enter the socket and that no leads become bent either under the I.C. or to the side of the I.C.

8.5 Removal of Components from Printed Circuit Boards:

Model BWD 603B uses one double-sided and several single-sided etched circuit boards. Care in removing components must be exercised to prolong the usefulness of the circuit board.

8. MAINTENANCE: (continued)

8.5 Removal of Components from Printed Circuit Boards: (cont'd.)

Before attempting a repair determine, if possible, the faulty component and remove only that component. (Be sure the trouble cannot be cured by an adjustment). Turn off power before attempting removal. The first step is to clip the leads near the component, and remove the component.

Then apply the soldering iron tip to the conductor side of the board at the component lead which is then removed with a straight upward motion. For large components with the leads rigidly connected, i.e. preset potentiometers, the soldering iron tip should be rotated from lead to lead while applying pressure to the component to lift it from the circuit board.

8.6 Repair of Printed Circuit Boards:

Generally when replacing components on a circuit board two types of damage can take place:-

- a. A conductor strip can lift from the board.
- b. A conductor strip may break.

A lifted strip may be re-cemented with a quick drying acetate cement having good electrical insulation characteristics.

A broken conductor strip may be joined by a short length of tinned copper wire. DO NOT attempt to bridge a break with solder.

8.7 Removal of Front Panel Controls:

This Section describes the removal of all front panel rotary controls except the frequency vernier:-

- a. The knob may be removed by loosening the grub screw(s) in the side. There are two types of grub screws, one requiring a 3/64" AF hexagonal key and the other requiring a 5/64" AF hexagonal key.
- b. The wires soldered to the control should now be unsoldered after making a note of their connection.
- c. Using a 1/2" AF ring or tube spanner, remove the nut holding the control to the front panel.
- d. The control may now be withdrawn from the panel.
- e. Assembly is done in the reverse order.

8. MAINTENANCE: (continued)

8.8 Removal of the Frequency Dial and Control:

- a. Loosen the grub screw(s) in the side of the knob with a 5/64" hexagonal key, and remove the knob.
- b. Remove the two brass screws holding the dial to the reduction drive, and take the dial off the shaft.
- c. Inside the unit note the connection of all wires to PC board 160/283B and then remove them.
- d. Loosen the two grub screws holding the potentiometer shaft to the reduction drive.
- e. Remove the two front panel screws on either side of the hole in the panel. Remove the PC board.
- f. Remove the potentiometer from the board.

9. REPLACEMENT PARTS:

- 9.1 Spares are normally available from the manufacturer, BWD Precision Instruments Pty. Ltd. When ordering it is necessary to indicate the model and serial number of the instrument. If exact replacements are not to hand, locally available alternatives may be used, provided they possess a specification not less than, or physical size not greater than the original components.
- 9.2 As the policy of BWD Precision Instruments Pty. Ltd. is one of continuing research and development, the Company reserves the right to supply the latest equipment and make amendments to circuits and parts without notice.

10. GUARANTEE:

The equipment is guaranteed against faulty materials and workmanship for a period of (12) months from the date of purchase.

Please refer to the Guarantee Registration Card which accompanied the instrument, for full details of conditions of warrant.

11. PARTS LIST:

11.1 Component Designations:

A	Assembly	H	Heater	RV	Variable Resistor
B	Lamp	J	Jack (Socket)	S	Switch
C	Capacitor	L	Indicator	T	Transformer
D	Diode	M	Meter	TH	Thermistor
DL	Delay Line	P	Plug	V	Vacuum Tube
E	Misc. Elec. Part	Q	Transistor	VDR	Volt Dependent Resistor
F	Fuse	R	Resistor		

11.2 Abbreviations:

Amp	Ampere	MPC	Metalised Polyester Capacitor
cc	Cracked Carbon	Ne	Neon
c	Carbon	NPO	Zero Temperature Co-efficient
CDS	Ceramic Disc	ns	Nano-second
cer	Ceramic	p	Peak
DPST	Double Pole Single Throw	pf	Pico Farad = 10^{-12} F
DPDT	Double Pole Double Throw	preset	Internal Preset
elec	Electrolytic	PYE	Polyester
FET	Field Effect Transistor	pot	Potentiometer
HTC	High Temp. Coating	PCB	Printed Circuit Board
kHz	Kilohertz = 10^3 Hz	PIV	Peak Inverse Voltage
k Ω	Kilohm = $10^3\Omega$	PYS	Polystyrene
Lin	linear	p-p	Peak to Peak
Log	Logarithmic Taper	rot	Rotary
m	Milli = 10^{-3}	rms	Root Mean Squared
MHz	Mega-hertz = 10^6 Hz	si	Silicon
MF	Metal Film	Ta	Tantalum
mA	Milliamperes = 10^{-3} Amp	tol	Tolerance
M Ω	Megohm = $10^6\Omega$	trim	Trimmer
mfr	Manufacturer	V	Volts
MO	Metal Oxide	var	Variable
MHT	Polyester/Paper Capacitor	W	Watt
		ww	Wire Wound

11.3 Manufacturer's Abbreviations:

AC	Allied Capacitors P/L	McM	McMurdo Aust. P/L
AGN	A.G. Naunton & Co. P/L	MOT	Motorola Semiconductor Inc.
AWA	Amalgamated Wireless Aust. Limited	NS	NS Electronics P/L
BWD	BWD Instruments Pty.Ltd.	NSF	NSF Limited
E	Electrosil Limited	PH	Philips Industries Limited
ELN	Elna Capacitors (Soanar)	S	Soanar Electronics P/L
F	Fairchild Aust. P/L	Siem	Siemens Industries Limited
HW	Hurtle Webster P/L	STE	Stettner Capacitors Limited
IRH	IRH Components P/L		

PARTS LIST - MODEL BWD 603B DRAWING NO. 1358

CCT REF	DESCRIPTION				MFR. OR SUPPLY	PART NO.
	RESISTORS (Fixed & Variable)					
R98	18K	1/4W	5%	MF		
R99	68Ω	1/4W	5%	MF		
R100	330Ω	1/4W	5%	MF		
R101	3K3	1/4W	5%	MF		
R102	100K	1/4W	5%	MF		
R103	15K	1/4W	5%	MF		
R104	10K	1/4W	5%	MF		
R105	100K	1/4W	5%	MF		
R106	120K	1/4W	5%	MF		
R107	10K	1/4W	5%	MF		
R108	4K7	1/4W	5%	MF		
R109	820Ω	1/4W	5%	MF		
R110	820Ω	1/4W	5%	MF		
R111	1K8	1/4W	5%	MF		
R112	4K7	1/4W	5%	MF		
R113	1K	1/4W	5%	MF		
R114	100K	1/4W	5%	MF		
R115	33K	1/4W	1%	MF		
R116	100K	1/4W	1%	MF		
R117	100K	1/4W	1%	MF		
R118	33K	1/4W	1%	MF		
R119	8K2	1/4W	5%	MF		
R120	2K7	1/4W	5%	MF		
R121	220Ω	1/4W	5%	MF		
R122	220Ω	1/4W	5%	MF		
R123	330Ω	1/4W	5%	MF		
R124	10Ω	1/4W	5%	MF		
R125	1K2	1/4W	5%	MF		
R126	150Ω	1/4W	5%	MF		
R127	560Ω	1/4W	5%	MF		
R128	1K5	1/4W	5%	MF		
R129	680Ω	1/4W	5%	MF		
R130	3K9	1/4W	5%	MF		
R131	1K	1/4W	5%	MF		
R132	100Ω	1/4W	5%	MF		
R133	330Ω	1/4W	5%	MF		
R134	560Ω	1/4W	5%	MF		
R135	1K2	1/4W	5%	MF		
R136	1K	1/4W	5%	MF		
R137	390Ω	1/4W	5%	MF		
R138	1K8	1/4W	5%	MF		
R139	560Ω	1/4W	5%	MF		
R140	560Ω	1/4W	5%	MF		
R141	560Ω	1/4W	5%	MF		
R142	47Ω	1/4W	5%	MF		
R143	470Ω	1/4W	5%	MF		
R144	560Ω	1/4W	5%	MF		
R145	47Ω	1/4W	5%	MF		
R146	6K8	1/4W	5%	MF		
R147	1K8	1/4W	5%	MF		
R148	1K8	1/4W	5%	MF		
R168	100Ω	1/4W	5%	MF		
R169	100Ω	1/4W	5%	MF		
R171	1K8	1/4W	5%	MF		

PARTS LIST - MODEL BWD 603B DRAWING NO. 1358 cont'd.

CCT REF	DESCRIPTION				MFR. OR SUPPLY	PART NO.
<u>RESISTORS</u> (Fixed & Variable) cont'd.						
RV1	5K	Cermet	Var	Preset	S	VTP
RV2	10K	WWLin	Var	2 Watt	AGN	
RV3	2K	Cermet	Var	Preset	S	VTP
RV4	10K+10K	C LIN	Var		S	VGU
RV5	100Ω	Cermet	Var	Preset	S	VTP
RV6	50Ω	Cermet	Var	Preset	S	VTP
RV8	2K	Cermet	Var	Preset	S	VTP
RV103	5K	Cermet	Var	Preset	S	VTP
RV106	500Ω	Cermet	Var	Preset	S	VTP
RV107	2K	Cermet	Var	Preset	S	VTP
RV109	2K	Cermet	Var	Preset	S	VTP
<u>CAPACITORS</u> (Fixed & Variable)						
C99	0.0047μF	100V		Greencap		
C100	0.0047μF	100V		Greencap		
C101	47pF	600V		5% N750 CDS		
C102	22pF	600V		5% NPO CDS		
C103	910pF	630V		5% PYS	AC	
C104	0.01μF	250V		1% PYC	Siem	MKMB32541-A3103J
C105	0.1μF	250V		1% PYC	Siem	MKMB32541-A3104J
C106	1μF	100V		1% PYC	Siem	MKMB32541-A1105J
C107	10μF	16V		10% Ta	S	TAD
C108	100μF	3V		10% Ta	S	TAD
C109	470μF	6.3V		elec	PH	2222-016-13471
C110	470μF	6.3V		elec	PH	2222-016-13471
C111	0.1μF	63V		CDS	S	TL
C112	0.1μF	63V		CDS	S	TL
C113	33pF	600V		5% N750 CDS		
C114	0.1μF	63V		CDS		
C115	0.1μF	63V		CDS	S	TL
C116	680pF	630V		5% N750 CDS		
C117						
C118	4p7	600V		10% NPO CDS		
C120	3p3	600V		10% NPO CDS		
C130	10μF	25V		Ta		
C131	10μF	25V		Elec		
C132	22μF	25V		Ta		
C133	10μF	25V		Elec		
C134	22μF	25V		Ta		
C141	12pF	600V		10% NPO CDS		
C142	220μF	10V		RB ELEC		
C14	10-40pF	Var Preset	Cer		STE	10S-06
C16	10-40pF	Var Preset	Cer		STE	10S-06
C23	4-20pF	Var Preset	Cer		STE	10S-06
C24	2-10pF	Var Preset			Philips	2222-808-11109

PARTS LIST - MODEL BWD 603B DRAWING NO. 1358 cont'd.

CCT REF	DESCRIPTION	MFR. OR SUPPLY	PART NO.
<u>SEMICONDUCTORS</u>			
D101	Diode Si	PH	1N4148
D102	Diode Si	PH	1N4148
D103	Diode Si	PH	1N4148
D104	Diode Si	PH	1N4148
D105	Diode Si	PH	1N4148
D106	Diode Si	PH	1N4148
D107	Diode Si	PH	1N4148
D115	Diode Si	PH	1N4148
D116	Diode Si	PH	1N4148
D117	Diode Si	PH	1N4148
D118	Diode Si	PH	1N4148
D119	Diode Si	PH	1N4148
D120	Diode Si	PH	1N4148
D121	Diode Si		1N4004
D122	Diode Si		1N4004
D123	Zener Diode Si	PH	BZX79C9V1
D126	Diode Si	PH	1N4148
D127	Diode Si	PH	1N4148
Q1	Transistor NPN Si	PH	BC547
Q2	Transistor PNP Si	PH	BC557
Q3	Transistor PNP Si	PH	BC557
Q4	Transistor NPN Si	PH	BC547
Q5	Transistor NPN Si	PH	BC547
Q6	Transistor NPN Si	PH	BC547
Q7	Transistor NPN Si		2N5770
Q8	Transistor NPN Si		2N5770
Q9	Transistor PNP Si		PN4121
Q10	Transistor NPN Si		2N5769
Q11	Transistor NPN Si		2N5769
U1	Quad Operational Amplifier	NS	LM324N
U2	High Speed Comparator	NS	(LM360N) (LM360N-14)
U3	Positive 6 Volt Regulator	NS	LM340T-6
U4	Negative 5 Volt Regulator	NS	LM7905
U5	Dual FET	NS	MPD8303CN
U100	Transistor Array	NS or RCA	LM3046

PARTS LIST - MODEL BWD 603B DRAWING NO. 1358 cont'd.

CCT REF	DESCRIPTION	MFR. OR SUPPLY	PART NO.
	<u>MISCELLANEOUS</u>		
S1A-B	3 Pos 2 Pole Slide Switch	NSF	SM2-3
S3A-B)		
S4A-B)		
S5A-B)		
S6A-B) 7 Section Push Button Switch	BWD	100-082-1
S7A-B)		
S8A-B)		
S9A-B)		
TH1	Thermistor	STC	CZ3
	For all other Parts, order by description, quoting instrument type and serial number.		

PARTS LIST - MODEL BWD 603B DRAWING NO. 1357

CCT REF	DESCRIPTION				MFR. OR SUPPLY	PART NO.
	<u>RESISTORS (Fixed & Variable)</u>					
R149	3K9	1W	5%	MF		
R150	4K7	1W	5%	MF		
R151	68Ω	1/4W	5%	MF		
R152	39K	1/4W	5%	MF		
R153	5K6	1/4W	5%	MF		
R154	150K	1/4W	5%	MF		
R155	56K	1/4W	5%	MF		
R156	22K	1/4W	5%	MF		
R157	2K7	1/4W	5%	MF		
R158	68K	1/4W	5%	MF		
R159	330Ω	1/4W	5%	MF		
R160	270Ω	1/4W	5%	MF		
R161	1K	1/4W	5%	MF		
R162	6K8	1/4W	5%	MF		
R163	1K	1/4W	5%	MF		
R164	1K2	1/4W	5%	MF		
R165	1K8	1/4W	5%	MF		
R166	820Ω	1/4W	5%	MF		
R167	5K6	1/4W	5%	MF		
R170	5K1	1/4W	5%	MF		
R171	1K8	1/4W	5%	MF		
R240	27K	1W	5%	MF		
R241	10Ω	1/4W	5%	MF		
R242	10Ω	1/4W	5%	MF		
R243	15Ω	1/4W	5%	MF		
R244	1K	1/4W	5%	MF		
R245	1K	1/4W	5%	MF		
R246	4K7	1/4W	5%	MF		
R247	1K	1/4W	5%	MF		
R248	27K	1W	5%	MF		
R401	33K	1/4W	5%	MF		
R402	10K	1/4W	5%	MF		
R403	12K	1/4W	5%	MF		
R404	5K6	1/4W	5%	MF		
R405	1K	1/4W	5%	MF		
R406	120K	1/4W	5%	MF		
R407	100K	1/4W	5%	MF		
R408	100K	1/4W	5%	MF		
R409	100K	1/4W	5%	MF		
R410	4K7	1/4W	5%	MF		
R411	1K	1/4W	5%	MF		
R412	560Ω	1/4W	5%	MF		
R413	560Ω	1/4W	5%	MF		
R414	10M					
R501	470Ω	1/4W	5%	MF		
R502	2K2	1/4W	5%	MF		
R503	22K	1/4W	5%	MF		
R504	220Ω	1/4W	5%	MF		
R505	10K	1/4W	5%	MF		
R506	4K7	1/4W	5%	MF		
R507	33Ω	1/4W	5%	MF		
R508	4K7	1/4W	5%	MF		
R509	470Ω	1/4W	5%	MF		
R510	33Ω	1/4W	5%	MF		
R511	560Ω	1/4W	5%	MF		

PARTS LIST - MODEL BWD 603B DRAWING NO. 1357 cont'd.

CCT REF	DESCRIPTION				MFR. OR SUPPLY	PART NO.
	<u>RESISTORS (Fixed & Variable) cont'd.</u>					
R512	62	1/4W	5%	MF		
R513	560Ω	1/4W	5%	MF		
R514	560Ω	1/4W	5%	MF		
RV101	10K	Cermet	Var	Preset	S	VTP
RV102	10K	Cermet	Var	Preset	S	VTP
RV104	10K C	LIN VAR c/w DPST Switch			IRH	
RV108	10K	Cermet	Var	Preset	S	VTP
RV110	5K C	LIN	Var		S	VCU
RV111	10K	Cermet	Var	Preset	S	VTP
RV112	2K	Cermet	Var	Preset	S	VTP
RV204	5K	Cermet	Var	Preset	S	VTP
RV7	100K C	LIN	Var		S	VCU
RV401	10K +10K C	LIN	Var	Ganged	-	See RV4
	<u>CAPACITORS</u>					
C119	15pF	600V	5% N750	CDS		
C121	0.1μF	63V		CDS	S	TL
C122	0.1μF	63V		CDS	S	TL
C123	0.1μF	63V		CDS	S	TL
C124	0.1μF	63V		CDS	S	TL
C125	0.1μF	63V		CDS	S	TL
C126	0.1μF	63V		CDS	S	TL
C127	0.1μF	63V		CDS	S	TL
C128	33pF	600V	5% N750	CDS		
C129	10pF	600V	5% N750	CDS		
C137	3p3	600V	10% NPO	CDS		
C138	0.1μF	63V		CDS	S	TL
C204	1μF	250V		PYE		
C205	8μF	350V		ELEC		
C135	100μF	25V		ELEC	PH	2222-016-16101
C136	100μF	25V		ELEC	PH	2222-016-16101
C140	0.1μF	63V		CDS	S	TL
C320	47uf	160V		ELEC	S	2222-040-11509
C321	47uf	160V		ELEC	S	2222-040-11509
C322	100pf	600V	5% N750	CDS		
C401	0.1μF	63V		CDS	S	TL
C402	22μF	25V	10%	Ta	S	
C403	0.1μF	63V		CDS	S	TL
C404	0.1μF	63V		CDS	S	TL
C405	0.1μF	63V		CDS	S	TL
C406	0.1μF	63V		CDS	S	TL

PARTS LIST - MODEL BWD 603B DRAWING NO. 1357 cont'd.

CCT REF	DESCRIPTION	MFR. OR SUPPLY	PART NO.	
<u>SEMI CONDUCTORS</u>				
D124	Diode	Si	PH	IN4148
D125	Diode	Si	PH	IN4148
D212	Diode	Si		IN4004
D213	Diode	Si	MOT	MR754
D401	Diode	Si	PH	IN4148
D402	Diode	Si	PH	IN4148
D403	Diode	Si	PH	IN4148
D404	Diode	Si	PH	IN4148
D405	Diode	Si		IN4004
D406	Diode	Si		IN4004
D320	Diode	Si		IN4004
D321	Diode	Si		IN4004
D501	Diode	Si		IN4004
D502	Diode	Si		IN4004
Q100	Transistor NPN	Si	PH	BC547
Q101	Transistor NPN	Si	PH	BC547
Q102	Transistor PNP	Si		PN4121
Q103	Transistor NPN	Si	PH	BC547
Q204	Transistor NPN	Si	MOT	MJE340
Q205	Transistor NPN	Si	PH	BC547
Q206	Transistor NPN	Si	MOT	MJE340
Q401	Transistor PNP	Si	PH	BC557
Q207	Transistor NPN	Si	MOT	MJE340
Q208	Transistor NPN	Si	MOT	MJE340
U101	Variable Gain Amplifier		MOT	MC1445L
U105	Operational Amplifier		NS	LF351N
U106	Operational Amplifier		NS	LF351N
U108	Operational Amplifier		NS	LM318N
U401	Quad Operational Amplifier		NS	LM324N
U402	Operational Amplifier		NS	LF351N
U501	Dual FET		NS	NP8303CN

PARTS LIST - MODEL BWD 603B DRAWING NO. 1357 cont'd.

CCT REF	DESCRIPTION	MFR. OR SUPPLY	PART NO.
	<u>MISCELLANEOUS</u>		
S100 S101 S102)) 3 Section Pushbutton Switch)	BWD	100-083-1
S103A-B S104	DPDT Slide Switch DPST Switch (Rear RV104) (Push Pull)	McM	1299-02-01
	For all other Parts, order by description, quoting instrument type and serial number.		

PARTS LIST - MODEL BWD 603B DRAWING NO. 1355

CCT REF	DESCRIPTION				MFR. OR SUPPLY	PART NO.
<u>RESISTORS</u> (Fixed & Variable)						
R200	82K	1/4W	5%	MF		
R201	10K	1/4W	5%	MF		
R202	100K	1/4W	5%	MF		
R203	10K	1/4W	5%	MF		
R204	10K	1/4W	5%	MF		
R205	10K	1/4W	5%	MF		
R206	150Ω	1/4W	5%	MF		
R207	22Ω	1/4W	5%	MF		
R208	470Ω	1W	5%	MF		
R209	22Ω	1/4W	5%	MF		
R210	150Ω	1/4W	5%	MF		
R211	47Ω	1/4W	5%	MF		
R212	470Ω	1W	5%	MF		
R213	47Ω	1/4W	5%	MF		
R214	1Ω	5W	5%	WW	HW	
R215	1Ω	5W	5%	WW	HW	
R216	560Ω	1W	5%	MF		
R217	10K	1/4W	5%	MF		
R218	560Ω	1W	5%	MF		
R219	220K	1/4W	5%	MF		
R220	10K	1/4W	5%	MF		
R221	10K	1/4W	5%	MF		
R222	10K	1/4W	5%	MF		
R223	10K	1/4W	5%	MF		
R224	470Ω	1/4W	5%	MF		
R225	1K5	1/4W	5%	MF		
R226	10M					
R227	10M					
R228	220Ω	1/4W	5%	MF		
R229	10K	1/4W	5%	MF		
R314	220Ω	2W	5%	MF		
R315	220Ω	2W	5%	MF		
R316	220Ω	2W	5%	MF		
R317	220Ω	2W	5%	MF		
R318	470Ω	1/4W	5%	MF		
R319	470Ω	1/4W	5%	MF		
R320	1K5	1/4W	5%	MF		
R321	220Ω	1/4W	5%	MF		
R322	1K5	1/4W	5%	MF		
R323	470Ω	1/4W	5%	MF		
R324	680Ω	1/4W	5%	MF		
R325	680Ω	1/4W	5%	MF		

PARTS LIST - MODEL BWD 603B DRAWING NO. 1355 cont'd.

CCT REF	DESCRIPTION				MFR. OR SUPPLY	PART NO.
<u>RESISTORS (Fixed & Variable) cont'd.</u>						
R326	820 Ω	1/4W	5%	MF		
R327	820 Ω	1/4W	5%	MF		
RV200	10K	C LIN	VAR		S	VCU
RV201	220K	C LIN	VAR c/w DPST Switch		PH	
RV202	2K	Cermet	VAR	Preset	S	VTP
RV203	200K	Cermet	VAR	Preset	S	VTP
RV300	2K	Cermet	VAR	Preset	S	VTP
RV301	5K	C Lin	VAR		S	VCU
RV302	2K	Cermet	VAR	Preset	S	VTP
RV303	5K	C Lin	VAR		S	VCU
RV320	1K	Cermet	VAR	Preset	S	VTP
RV321	500Ω	Cermet	VAR	Preset	S	VTP
<u>CAPACITORS</u>						
C200	0.1μF	63V		CDS	S	TL
C201	12pF	600V	5% N750	CDS		
C202	0.022μF	100V	10%	PYE	S	N
C203	6.8pF	600V	5% N750	CDS		
C206	100μF	25V		Elec	PH	2222-016-16101
C207	100μF	25V		Elec	PH	2222-016-16101
C208	33pF	600V	5% N750	CDS		
C209	15pF	600V	10% N750	CDS		
C210	0.1μF	63V		CDS	S	TL
C211	100pF	600V	10% N750	CDS		
C300	4700μF	35V		Elec	ELN	Type RT
C301	4700μF	35V		Elec	ELN	Type RT
C302	100μF	25V		Elec	PH	2222-035-56101
C303	100μF	25V		Elec	PH	2222-035-56101
C310	4700μF	35V		Elec	ELN	Type RT
C311	4700μF	35V		Elec	ELN	Type RT

PARTS LIST - MODEL BWD 603B DRAWING NO. 1355 cont'd.

CCT REF	DESCRIPTION	MFR. OR SUPPLY	PART NO.	
<u>SEMI CONDUCTORS</u>				
D200	Diode	Si	PH	IN4148
D201	Diode	Si	PH	IN4148
D202	Diode	Si		IN4004
D203	Diode	Si		IN4004
D204	Diode	Si		IN4004
D205	Diode	Si		IN4004
D206	Diode	Si	PH	IN4148
D207	Diode	Si		IN4004
D208	Diode	Si		IN4004
D209	Diode	Si		IN4004
D210	Diode	Si		IN4004
D211	Diode	Si		IN4004
D214	Diode	Si	PH	IN4148
D215	Diode	Si	PH	IN4148
D216	Diode	Si	PH	IN4148
D217	Diode	Si	PH	IN4148
D218	Diode	Si	PH	IN4148
D225	Diode	Si		IN4004
D300	Diode	Si		A14P
D301	Diode	Si		A14P
D302	Diode	Si		A14P
D303	Diode	Si		A14P
D304	Diode	Si		A14P
D305	Diode	Si		A14P
D306	Diode	Si		A14P
D307	Diode	Si		A14P
D308	Diode	Si		A14P
D309	Diode	Si		A14P
D310	Diode	Si		A14P
D311	Diode	Si		A14P
D312	Diode	Si		A14P
D313	Diode	Si		A14P
D314	Diode	Si		A14P
D315	Diode	Si		A14P
D316	Diode	Si		IN4004
D317	Diode	Si		IN4004

PARTS LIST - MODEL BWD 603B DRAWING NO. 1355 cont'd.

CCT REF	DESCRIPTION	MFR. OR SUPPLY	PART NO.
<u>SEMI CONDUCTORS</u> cont'd.			
Q200	Transistor NPN Si	NAT	PN100
Q201	Transistor PNP Si	NAT	PN200
Q202	Transistor PNP Si	MOT	MJ 2955
Q203	Transistor NPN Si	MOT	2N3055
U200	Operational Amplifier	NS	(LF351N LF356N)
U201	Operational Amplifier	NS	LM318N
U300	3 Terminal Adjustable Regulator	NS	LM317T
U301	3 Terminal Adjustable REgulator	NS	LM317T
U302	3 Terminal Negative Regulator	NS	LM7912
U303	3 Terminal Adjustable Regulator	NS	LM317T
<u>MISCELLANEOUS</u>			
B300	Neon Indicator	S	MB227
F300	Fuse 5 Amp Q.B. 3AG		
F301	Fuse 5 Amp Q.B. 3AG		
F302	Fuse (1 Amp Delay(220V) 5 X 20mm) (2 Amp Delay(110V) 5 X 20mm)		
T300	Power Transformer	BWD	090-173-4
S300A-B	DPST Toggle Switch	NSF	8370K8
S301A-B	DPDT Slide Switch	AWA	62556-56003-004
S200A-B	3 Pos. 2 Pole Slide Switch	NSF	SM2-3
S201A-B	DPST Switch (Rear RV201)		
For all other Parts, order by description, quoting instrument type and serial number.			

RV200 VOLTAGE CONTROL (BI-POLAR P/S)
RV201 GAIN CONTROL (VOLTAGE AMP.)
RV202 SET MAX. GAIN (VOLTAGE AMP.)
RV203 SET DC OFFSET (VOLTAGE AMP.)

RV300 SET MAX. VOLTAGE (+1→+15V)
RV301 VOLTAGE CONTROL (+1→+15V)
RV302 SET MAX. VOLTAGE (-1→-15V)
RV303 VOLTAGE CONTROL (-1→-15V)
RV320 SET +15V (FIXED)
RV321 SET -15V (FIXED)

S300	AC POWER ON/OFF	POS'N SHOWN OFF
S301	AC POWER RANGE SELECTOR	190-265V
S200	P/A, P/S MODE SWITCH	BI-POLAR P/S
S201	OP. AMP., VOLTAGE AMP. (REAR RV201)	VOLTAGE AMP.