

VW Beta**+ RP (rot/red)**

7 648 220 060

VW Beta (rot/red)

7 648 222 060

VW Beta T4 + RP ((rot/red)

7 648 233 060

VW Beta DOT + RP (rot/red)

7 648 234 060

Skoda Beta**+ RP (grün/green)**

7 648 221 064

VW Beta Lupo

7 648 224 060

VW Beta T4 (rot/red)

7 648 235 060

VW Beta DOT (rot/red)

7 648 236 060

VW Gamma + RP (rot/red)

7 648 225 060

Skoda Gamma + RP**(grün/green)**

7 648 226 064

VW Gamma (rot/red)

7 648 227 060

VW New Beetle

7 648 229 060

VW Gamma Nokia**+ RP (rot/red)**

7 648 231 060

VW Gamma T4 + RP**(rot/red)**

7 648 237 060

VW Gamma Nokia**(rot/red)**

7 648 232 060

VW Gamma T4**(rot/red)**

7 649 239 060

8 622 401 985 BN 05/99

Serviceanleitung • Service Manual**(D) Weitere Dokumentationen**

Schaltbild	Skoda Beta	221 064,	
	VW Beta	220, 222, 224,	
		233 + 235	8 622 401 781
Ersatzteilliste	VW Beta	220, 222, 224	8 622 401 618
Ersatzteilliste	VW Beta	233 + 235	8 622 401 698
Schaltbild	VW Beta	234 + 236	8 622 401 833
Ersatzteilliste	VW Beta	234 + 236	8 622 401 813

Schaltbild	Skoda Gamma	226 064,	
	VW Gamma	225, 231, 232,	
		232, 237 + 239 ...	8 622 401 764
Ersatzteilliste	VW Gamma	225, 227	8 622 401 617
Ersatzteilliste	VW Gamma	226 064	8 622 401 694
Ersatzteilliste	VW Gamma	231 + 232	8 622 401 686
Ersatzteilliste	VW Gamma	237 + 239	8 622 401 804

Schaltbild	VW N.Beetle	229	8 622 401 764
Ersatzteilliste	VW N.Beetle	229	8 622 401 619

(GB) Supplementary documentation

Circuit Diagram	Skoda Beta	221 064,	
	VW Beta	220, 222, 224,	
		233 + 235	8 622 401 781
Spare Part List	VW Beta	220, 222, 224 ...	8 622 401 618
Spare Part List	VW Beta	233 + 235	8 622 401 698
Circuit Diagram	VW Beta	234 + 236	8 622 401 833
Spare Part List	VW Beta	234 + 236	8 622 401 813

Circuit Diagram	Skoda Gamma	226 064,	
	VW Gamma	225, 227, 231,	
		232, 237 + 239 ..	8 622 401 764
Spare Part List	VW Gamma	225, 227	8 622 401 617
Spare Part List	VW Gamma	226 064	8 622 401 694
Spare Part List	VW Gamma	231 + 232	8 622 401 686
Spare Part List	VW Gamma	237 + 239	8 622 401 804

Circuit Diagram	VW N.Beetle	229	8 622 401 764
Spare Part List	VW N.Beetle	229	8 622 401 619

D Bedienhinweise

Ein-/Ausschalten

Einschalten:

Drücken Sie den Knopf ⑩.

Ausschalten:

Drücken Sie den Knopf ⑩ nochmal.

GB Operating instructions

Switching on/off

Switching on:

Press button ⑩.

Switching off:

Press button ⑩ once again.



Eingeben der Code-Nummer

Nach dem Einschalten erscheint im Display die Anzeige:

"SAFE".

Nach 3 Sekunden erscheint die Anzeige

"1000".

Beispiel:

Die einzugebende Code-Nummer lautet **9 1 4 1**

Drücken Sie **9 x** die Stationstaste ① → **9 0 0 0**

Drücken Sie **1 x** die Stationstaste ② → **9 1 0 0**

Drücken Sie **4 x** die Stationstaste ③ → **9 1 4 0**

Drücken Sie **1 x** die Stationstaste ④ → **9 1 4 1**

Zum Bestätigen des 4-stelligen Codes drücken Sie die Taste ⑧ oder ⑨ länger als 2 Sekunden.

Wenn die falsche Code-Nummer eingegeben wurde erscheint der Schriftzug "SAFE".

Der gesamte Vorgang kann nun wiederholt werden.

Nach jeder weiteren Fehleingabe der Code-Nummer ist das Gerät für eine Stunde gesperrt und muß eingeschaltet bleiben.

Entering the code number

After power-up the display shows:

"SAFE".

After 3 seconds the following appears

"1000".

Example:

The code number might be **9 1 4 1**

Press preset button ① nine times → **9 0 0 0**

Press preset button ② once → **9 1 0 0**

Press preset button ③ four times → **9 1 4 0**

Press preset button ④ once → **9 1 4 1**

To confirm the 4-digit code, press key ⑧ or press key ⑨ more than 2 seconds.

If you have entered a wrong number, "SAFE" will appear in the display.

Repeat all steps to enter code again.

If you enter a wrong code again, the unit will shut down for one hour. The waiting time will elapse only if you keep the unit turned on.

D Allgemeine Abgleich- und Einstellhinweise

Höhen - Einstellung Mittelstellung
 Bass - Einstellung Mittelstellung
 Fader - Einstellung Mittelstellung
 Balance - Einstellung Mittelstellung

Lautsprecheranschluß

Der Lautsprecherausgang muß mit 4 Ω abgeschlossen sein.

AM + FM - Abgleich:

- Den AM- und FM-Abgleich müssen Sie durchführen, wenn bei einer Reparatur frequenzbestimmende Bauteile ausgetauscht oder verstellt wurden. Dazu müssen Sie das Autoradio teilweise demontieren.

Abschirmung

Der HF-Abgleich muß mit Unterdeckel erfolgen.

Belegung des Anschlußkästchens

A		B	
1	Gala	1	Lautspr. / Speaker Out (RR) +
2	Externer Mute / external mute	2	Lautspr. / Speaker Out (RR) -
3	K - Bus	3	Lautspr. / Speaker Out (RF) +
4	S - Kontakt (KL 15)	4	Lautspr. / Speaker Out (RF) -
5	Code + 12V	5	Lautspr. / Speaker Out (LF) +
6	Beleuchtung / Illumination	6	Lautspr. / Speaker Out (LF) -
7	Dauerplus / permanent voltage (KL 30)	7	Lautspr. / Speaker Out (LR) +
8	Masse / Ground	8	Lautspr. / Speaker Out (LR) -

GB Car radio alignment and settings

Treble adjustment center position
 Bass adjustment center position
 Fader adjustment center position
 Balance adjustment center position

Loudspeaker connections

The loudspeaker output must be terminated with 4 Ω.

AM + FM alignment:

- The AM and FM alignment has to be carried out if components that determine the circuit's frequency have been replaced or de-tuned. A disassembly in part will be necessary.







Radio-shielding

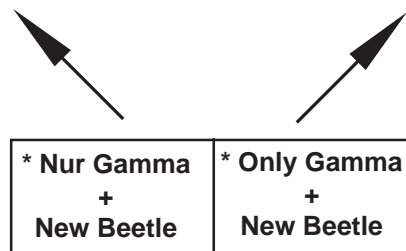
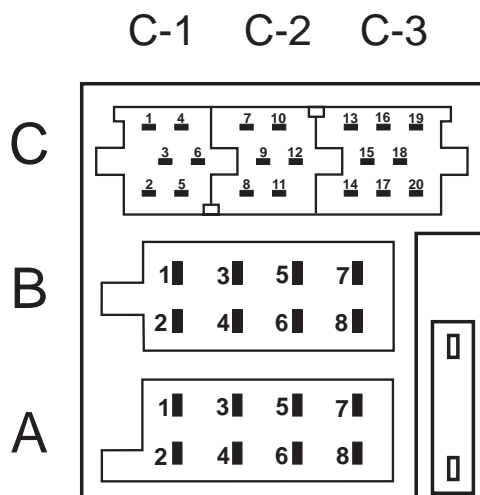

The r-f alignment has to be performed with the bottom cover in place.



Pinning of terminal box





C					
C1		C2		C3	
1	Line Out left rear (LR)	7	Telefon NF minus / AF phone minus	* 13	CD-Changer Data In
2	Line Out right rear (RR)	* 8	Ext.Display Clock	* 14	CD-Changer Data Out
3	Line Out Ground	* 9	Ext.Display Data	* 15	CD-Changer Clock
4	Line Out left front (LF)	* 10	Ext.Display Ena	* 16	CDC +12 V / +12 V CDC permanent
5	Line Out right front (RF)	11	Fernbedienung / Remote control	* 17	+12 V geschaltet / +12 V switched
6	+12 V geschaltet / +12 V switched	12	Telefon NF plus / AF phone plus	* 18	Changer Masse / Changer Ground
				* 19	Changer AF input (L)
				* 20	Changer AF input (R)



Position Position Position Posición	Bezeichnung Designation Dénomination Denominación	Bestell-Nr. Part no. No. de Commande Número de pedido
	SCHALTERPLATTE, SWITCH BOARD, PLAQUE D' INTERRUPT, PLACA DE INTERRUPT	
		
D 1000	ST 62T80	8 609 500 120
D 1001	M 74 HC 174M	8 925 904 155
		
H 1014	LSM 670	8 925 406 005
H 1050		
H 1059	LB T 676	8 925 406 001
H 1062-		
H 1089	LSM 670	8 925 406 005
		
V 815	BC 848 B	8 925 705 043
V 1010	BC 858 B	8 925 705 038
V 1050	BC 817-40	8 925 705 177
V 1051	BC 846 B	8 925 705 229
V 1052	BC 858 B	8 925 705 038
V 1053	BC 848 B	8 925 705 043
V 1054	BC 817-40	8 925 705 177
V 1055	BC 807-40	8 925 705 266
V 1057	BC 846 B	8 925 705 229
V 1058	BZX 84/C3V9	8 925 421 098
V 1059	BAW 56	8 925 405 015
V 1060	BAV 70	8 925 405 122
V 1061	BAW 56	8 925 405 015
V 1062	BAV 70	8 925 405 122
V 1087	BAV 99	8 925 405 124
V 1092	BZX 84/C3V9	8 925 421 098
		
Z 1000	8 MHz	8 926 193 045
Z 1001	32,768 kHz	8 926 193 059
	HAUPTPLATTE, MAIN BOARD, PLAQUETTE PRINCIPALE, PLACA PRINCIPAL	
		
C 2000	2700 µF	8 943 490 365
C 2001	2200 µF	8 943 490 130
		
D 150	SC 390253 FU	8 925 904 210
D 800	TMS 370 OP16B	8 609 500 101
D 801	M 92256 (... 220 060)	8 609 500 058
D 801	M 92256 (... 222 060)	8 609 500 058
D 801	M 92256 (... 224 060)	8 609 500 054
D 802	NM 25 C160 (... 220 060)	8 609 500 360
D 802	NM 25 C160 (... 222 060)	8 609 500 040
D 802	NM 25 C160 (... 224 060)	8 609 500 760
D 1100	HA 12198 F	8 925 904 132
D 1400	HCF 4066	8 925 900 019
D 1500	RC 4558	8 925 900 308
D 1570	RC 4558	8 925 900 308
D 1600	TDA 7376 B	8 945 903 286

Position Position Position Posición	Bezeichnung Designation Dénomination Denominación	Bestell-Nr. Part no. No. de Commande Número de pedido
D 2000	TLE 4269	8 925 904 244
D 2010	BSP 452	8 925 705 301
D 2011	L 4952	8 925 901 732
D 2022	L 78 M06	8 945 901 741
D 2030	BSP 452	8 925 705 301
D 5100	RC 4558	8 925 900 308
D 5300	MM 74 HC595M	8 925 900 434
D 5301	M 74 HC 160M1R	8 925 901 843
D 5302	MM 74 HC132MX	8 925 900 136
D 8200	L 9637	8 925 904 219
D 8280	LM 258 D	8 925 900 905
		
L 100		8 928 411 065
L 101		8 928 411 061
L 102		8 928 411 065
L 103		8 928 411 061
L 153		8 928 411 061
L 156		8 928 411 061
L 158		8 928 411 061
L 160		8 928 411 061
L 161		8 928 411 061
L 180		8 958 411 132
L 801		8 928 411 061
L 802		8 958 411 106
L 809		8 958 411 006
L 810		8 958 411 006
L 894		8 958 411 006
L 896		8 958 411 006
L 897		8 958 411 006
L 899		8 958 411 006
L 2000		8 948 411 065
L 5301		8 958 411 006
L 8220		8 958 411 006
		
V 800	BC 848 B	8 925 705 043
V 840	BC 858 B	8 925 705 038
V 841	BC 848 B	8 925 705 043
V 842	BC 818-40	8 925 705 228
V 880	BC 848 B	8 925 705 043
V 881	BAL 99	8 925 405 137
V 890	BC 858 B	8 925 705 038
V 895	BAS 21	8 925 405 182
V 900	BC 858 C	8 925 705 039
V 901	DTC 144 EK	8 925 705 264
V 915	BAV 70	8 925 405 122
V 931	BC 858 B	8 925 705 038
V 932	BC 848 B	8 925 705 043
V 990	BC 858 C	8 925 705 039
V 991	BAV 99	8 925 405 124
V 992	BC 848 B	8 925 705 043
V 1350	BC 807-40	8 925 705 266
V 1351	DTC 144 EK	8 925 705 264
V 1352	DTC 144 EK	8 925 705 264
V 1354	RLR 4001	8 925 800 044
V 1410	DTC 144 EK	8 925 705 264
V 1411	DTC 144 EK	8 925 705 264
V 1572	BAV 99	8 925 405 124
V 1574	BAV 99	8 925 405 124
V 1620	BAL 99	8 925 405 137
V 2000	S 3 G	8 925 405 023
V 2002	BAL 99	8 925 405 137

Position Position Position Posición	Bezeichnung Designation Dénomination Denominación	Bestell-Nr. Part no. No. de Commande Número de pedido
V 2003	BAL 99	8 925 405 137
V 2005	S 1 B	8 925 405 247
V 2020	BAL 99	8 925 405 137
V 2030	SS 14	8 925 405 323
V 2040	SS 14	8 925 405 323
V 2080	BC 848 B	8 925 705 043
V 2081	BC 858 B	8 925 705 038
V 2082	BC 848 C	8 925 705 037
V 2083	BC 848 C	8 925 705 037
V 2084	BC 858 B	8 925 705 038
V 2085	FMMT 493	8 925 705 192
V 2095	BC 848 C	8 925 705 037
V 2100	BC 848 C	8 925 705 037
V 2101	BC 848 C	8 925 705 037
V 2102	BAV 70	8 925 405 122
V 2103	BAV 70	8 925 405 122
V 2104	BC 858 C	8 925 705 039
V 2105	BC 848 B	8 925 705 043
V 2300	BC 858 B	8 925 705 038
V 2303	BAS 21	8 925 405 182
V 2701	BC 848 B	8 925 705 043
V 2702	BAL 99	8 925 405 137
V 5000	BZX 84/C5V6	8 925 421 037
V 5300	BZX 84/C5V6	8 925 421 037
V 5303	BZX 84/C5V6	8 925 421 037
V 8200	BC 808-25	8 925 705 042
V 8210	BAL 99	8 925 405 137
V 8211	BC 846 B	8 925 705 229
V 8212	BC 856 B	8 925 705 140
V 8214	BZX 84/C30	8 925 421 074
V 8215	BAL 99	8 925 405 137
V 8230	BC 808-25	8 925 705 042
V 8232	BZX 84/C18	8 925 421 059
V 8250	BZX 84/C18	8 925 421 059
V 8281	BAW 56	8 925 405 015
V 8282	BAV 70	8 925 405 122
V 8285	BZX 84/C4V7	8 925 421 061
V 8291	BAW 56	8 925 405 015
V 8292	BAV 70	8 925 405 122
V 8295	BZX 84/C4V7	8 925 421 061
		
Z 156	28,4961 MHz	8 926 193 066
Z 800	19,67 MHz	8 926 193 062
	HF - PLATTE, HF BOARD, PLAQUETTE HF, PLACA HF	8 635 123 130
		
D 1	TY 38477	8 925 904 301
		
L 3		8 948 419 072
L 50		8 958 411 133
L 51		8 948 419 073
L 52		8 958 411 000
L 53		8 958 411 106
L 54		8 948 419 073

Position Position Position Posición	Bezeichnung Designation Dénomination Denominación	Bestell-Nr. Part no. No. de Commande Número de pedido
L 600		8 958 411 106
L 601		8 958 411 158
L 602		8 958 411 152
L 603		8 958 411 152
L 604		8 958 411 152
L 610		8 958 411 169
L 612		8 958 411 102
L 2080		8 948 411 089
		
V 1	BB 814	8 925 405 146
V 50	BB 814	8 925 405 146
V 51	BA 885	8 925 405 530
V 52	BF 999	8 925 705 280
V 53	BB 814	8 925 405 146
V 600	2 SK 711BL	8 925 705 176
V 601	1 SV 172	8 925 405 318
V 602	S 247 Z	8 925 421 079
V 610	BAT 18-05	8 925 405 526
V 611	BAV 70	8 925 405 122
V 612	BF 999	8 925 705 280
		
Z 100		8 948 417 010
Z 110		8 926 193 211
Z 600		8 926 193 048
Hinweis: Handelsübliche Kondensatoren und Widerstände sind in der Ersatzteilliste nicht aufgeführt. Wir bitten Sie, diese Teile im Fachhandel zu beziehen.		Note: Capacitors and resistors usual in trade are not mentioned in the spare parts list. Kindly buy these parts from the specialized trade.
Nota: Des condensateurs et résistances commerciaux ne sont pas inclus dans la liste des pièces détachées. Veuillez acheter ces pièces chez votre spécialiste.		Nota: No se indican en la lista de piezas de repuestos los condensadores y los resistores de uso comercial. Les rogamos comprar esas piezas en el comercio especializado.

Blaupunkt-Werke GmbH, Hildesheim

Änderungen vorbehalten! Nachdruck - auch auszugsweise - nur mit Quellenangabe gestattet

Modification réservées! Reproduction - aussi en abrégé - permise seulement avec indication des sources utilisées

Gedruckt in Deutschland

Printed in Germany by HDR

Modification reserved! Reproduction - also by extract - only permitted with indication of sources used

Modificaciones reservadas! Reproducción - también en parte - solamente permitida con indicación de las fuentes utilizadas

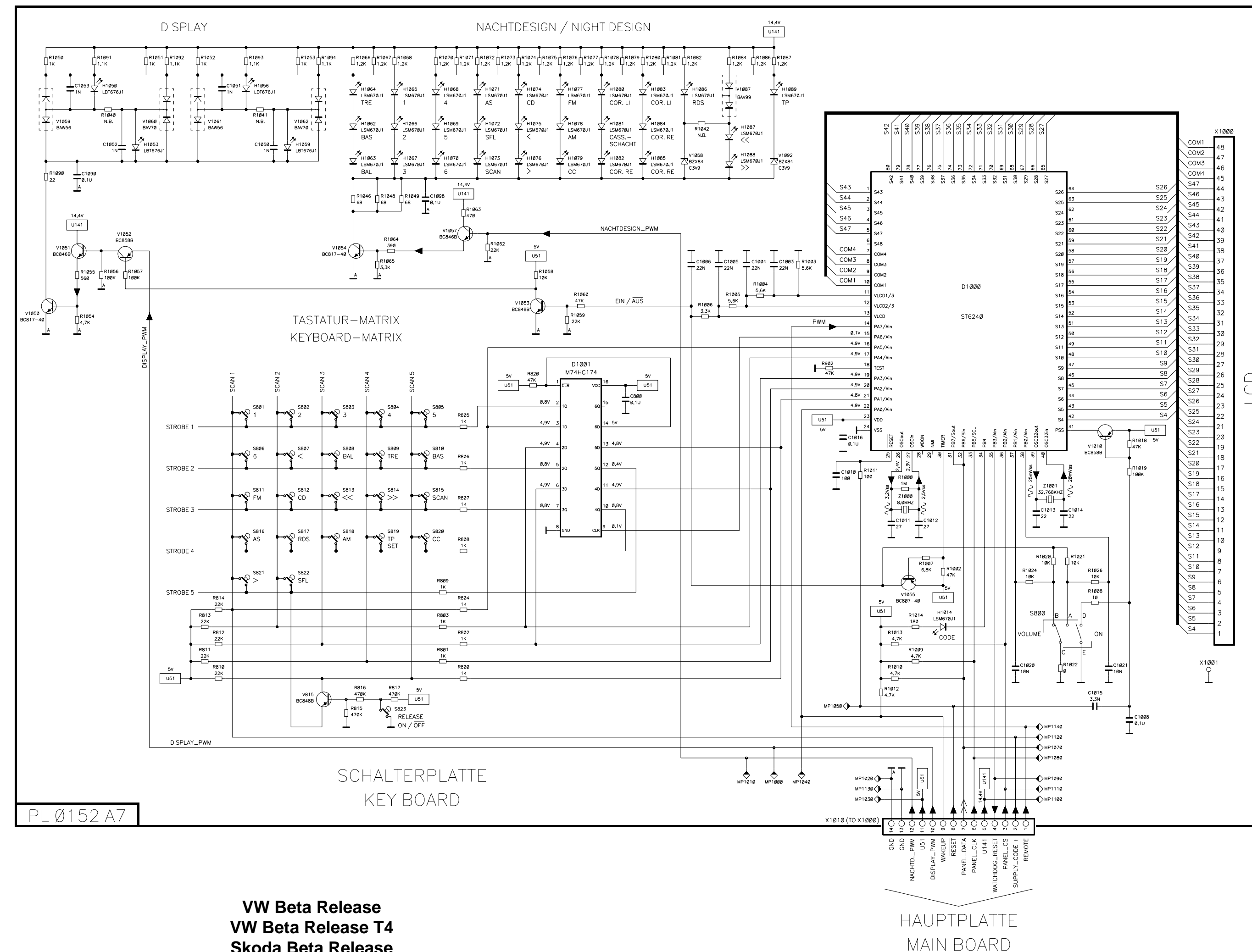
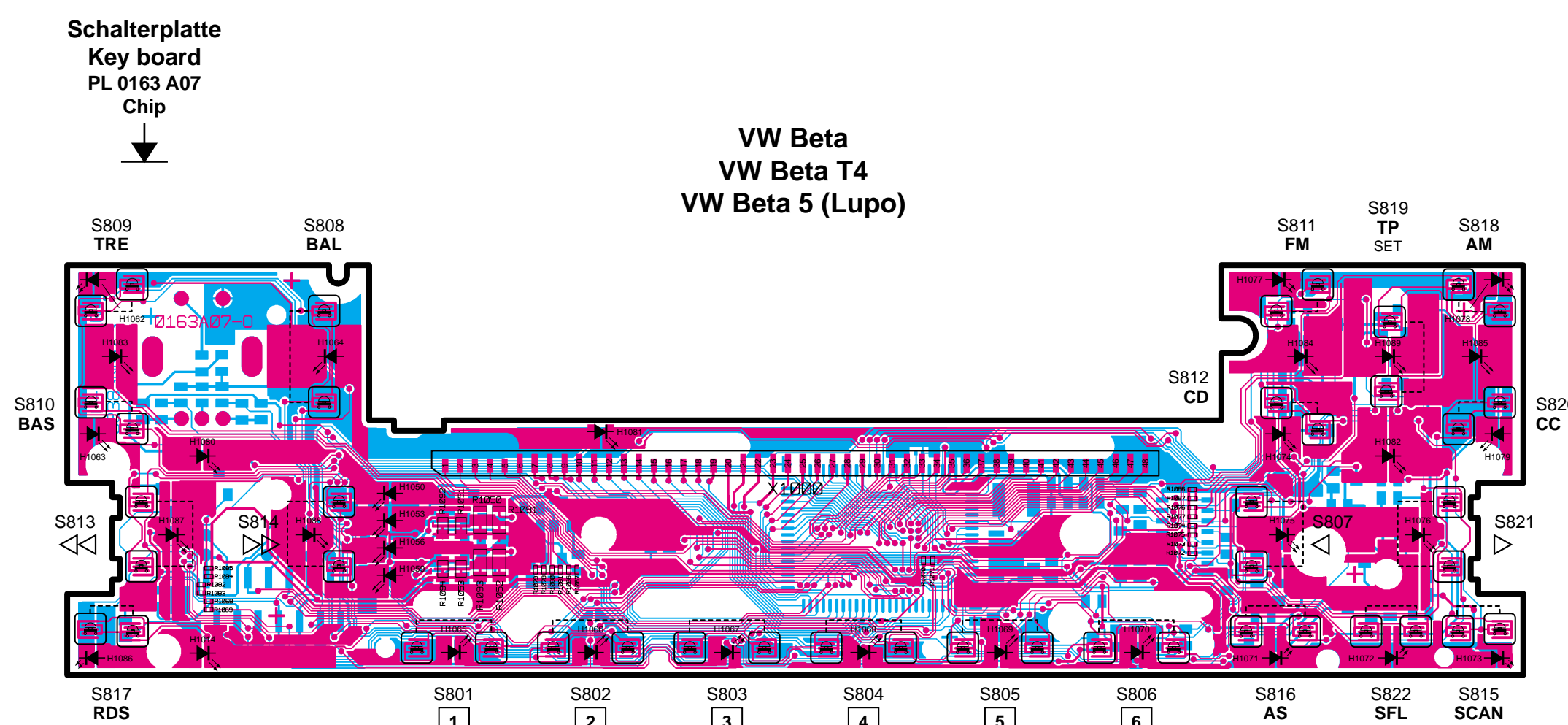
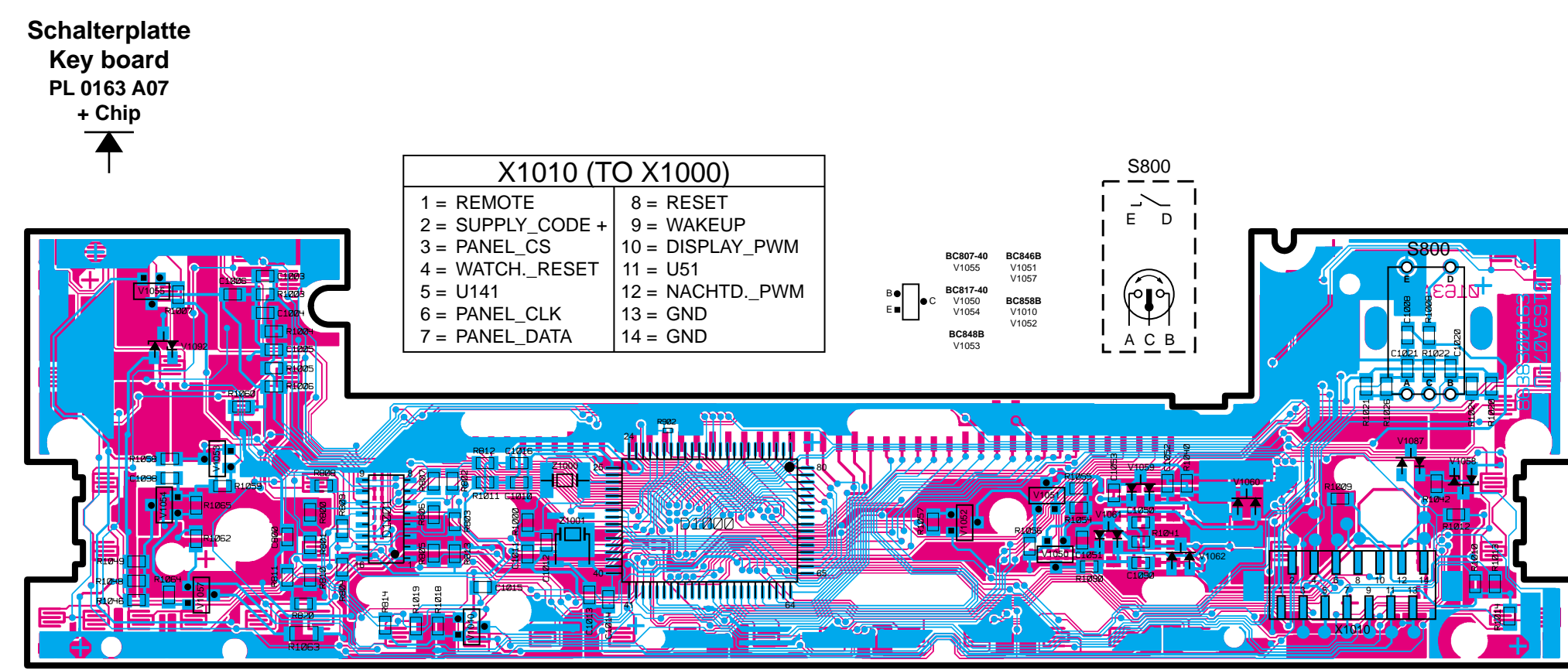
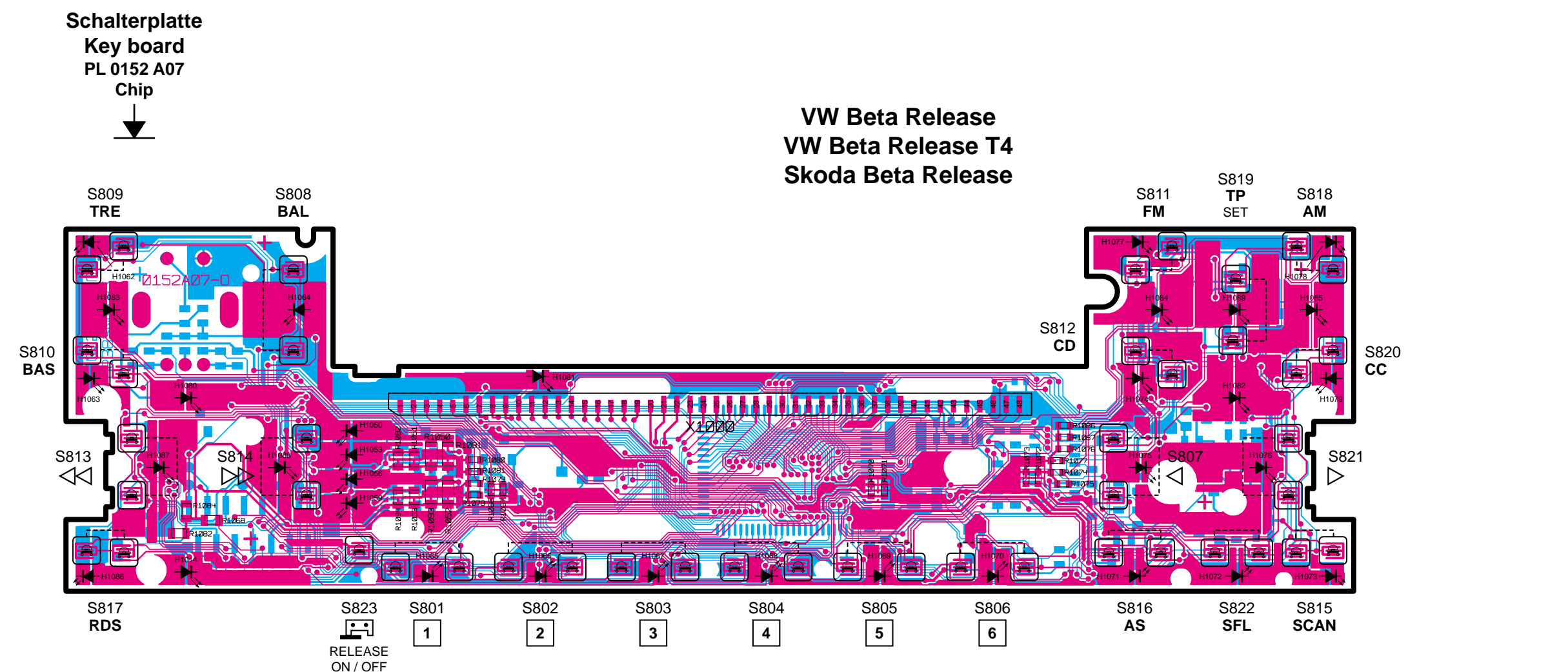
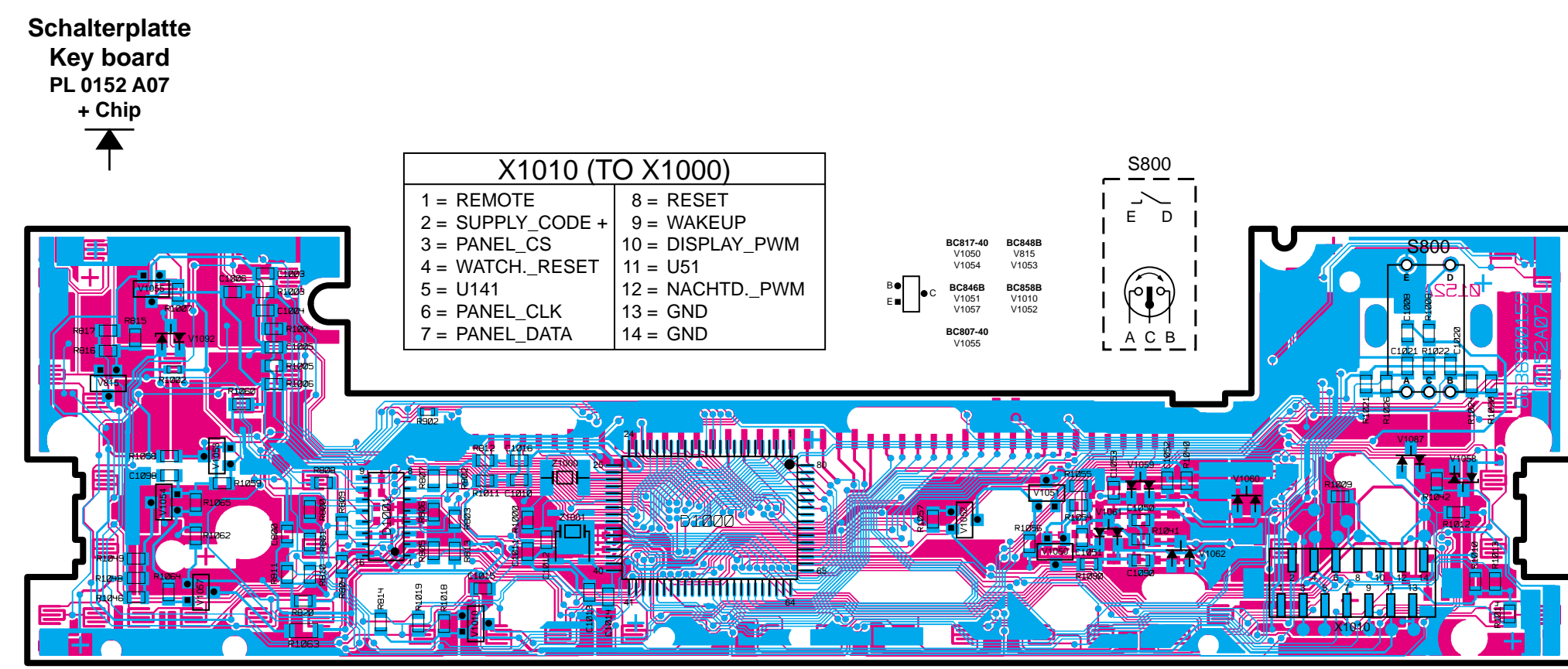

**VW Beta Release
VW Beta Release T4
Skoda Beta Release**

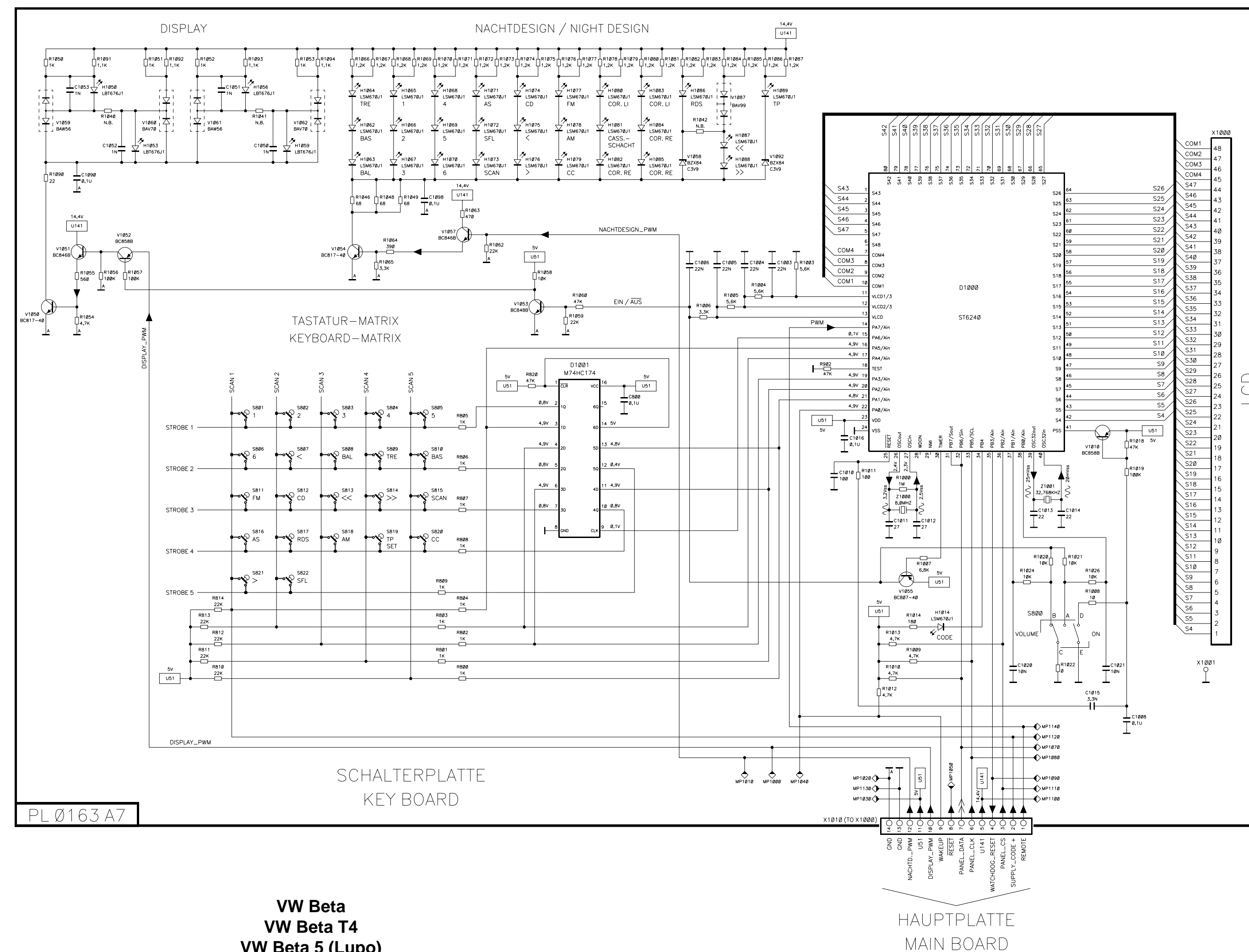

**VW Beta
VW Beta T4
VW Beta 5 (Lupo)**

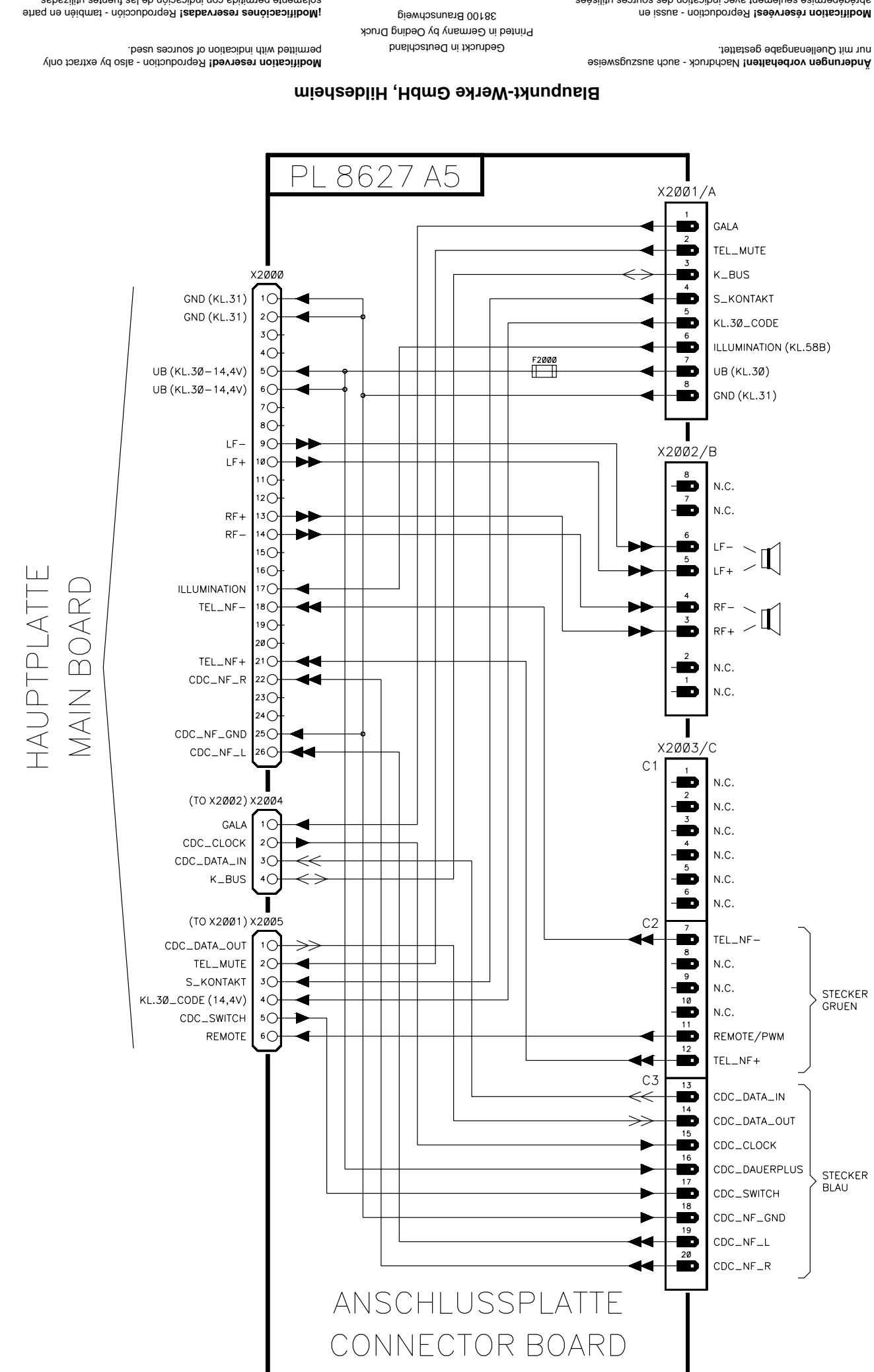

● BLAUPUNKT AUTORADIO		Skoda Beta
		7 648 223 060
		Skoda Beta Release
		7 648 221 064
		VW Beta
		7 648 222 060
		VW Beta Release
		7 648 220 060
		VW Beta 5 (Lupo)
		7 648 224 060

8 622 401 781 BN-WG 09/98

Schaltbild • Circuit diagram

**Anschlußplatte
Connector board
PL 8627 A05**

X2004 (TO 2002)

- 1 = CDC_CLOCK
- 2 = CDC_DATA_IN
- 3 = S_KONTAKT
- 4 = K_BUS

X2005 (TO 2001)

- 1 = CDC_DATA_OUT
- 2 = TEL_MUTE
- 3 = S_KONTAKT
- 4 = KL30_CODE
- 5 = CDC_SWITCH
- 6 = REMOTE

X2000

- 1 = GND (KL.31)
- 2 = GND (KL.31)
- 3 = N.C.
- 4 = N.C.
- 5 = UB (KL.30 - 14,4V)
- 6 = UB (KL.30 - 14,4V)
- 7 = N.C.
- 8 = N.C.
- 9 = LF+
- 10 = LF+
- 11 = N.C.
- 12 = N.C.
- 13 = RF+
- 14 = RF+
- 15 = N.C.
- 16 = N.C.
- 17 = ILLUMINATION
- 18 = TEL_NF-
- 19 = N.C.
- 20 = N.C.
- 21 = TEL_NF+
- 22 = CDC_NF_R
- 23 = N.C.
- 24 = N.C.
- 25 = CDC_NF_GND
- 26 = CDC_NF_L

TUNER

SCHALTERPLATTE
KEY BOARD

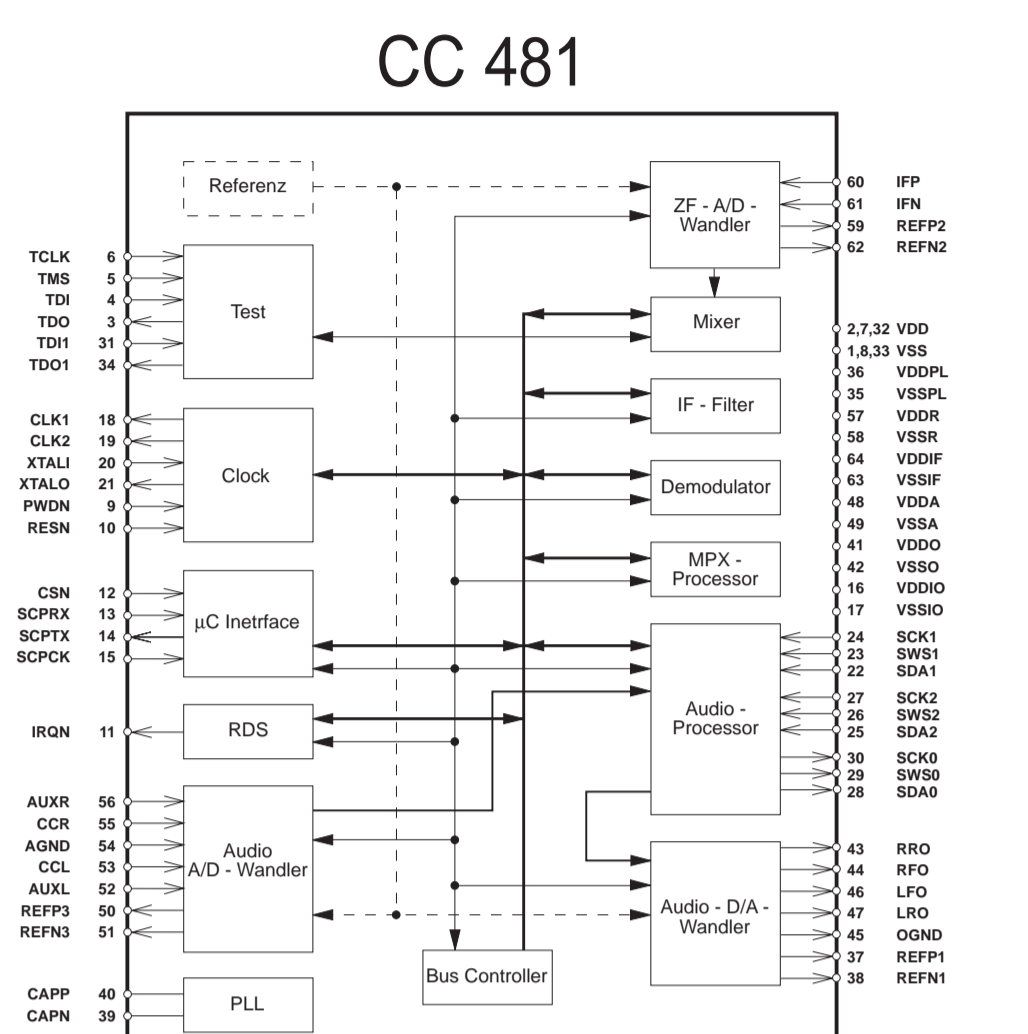
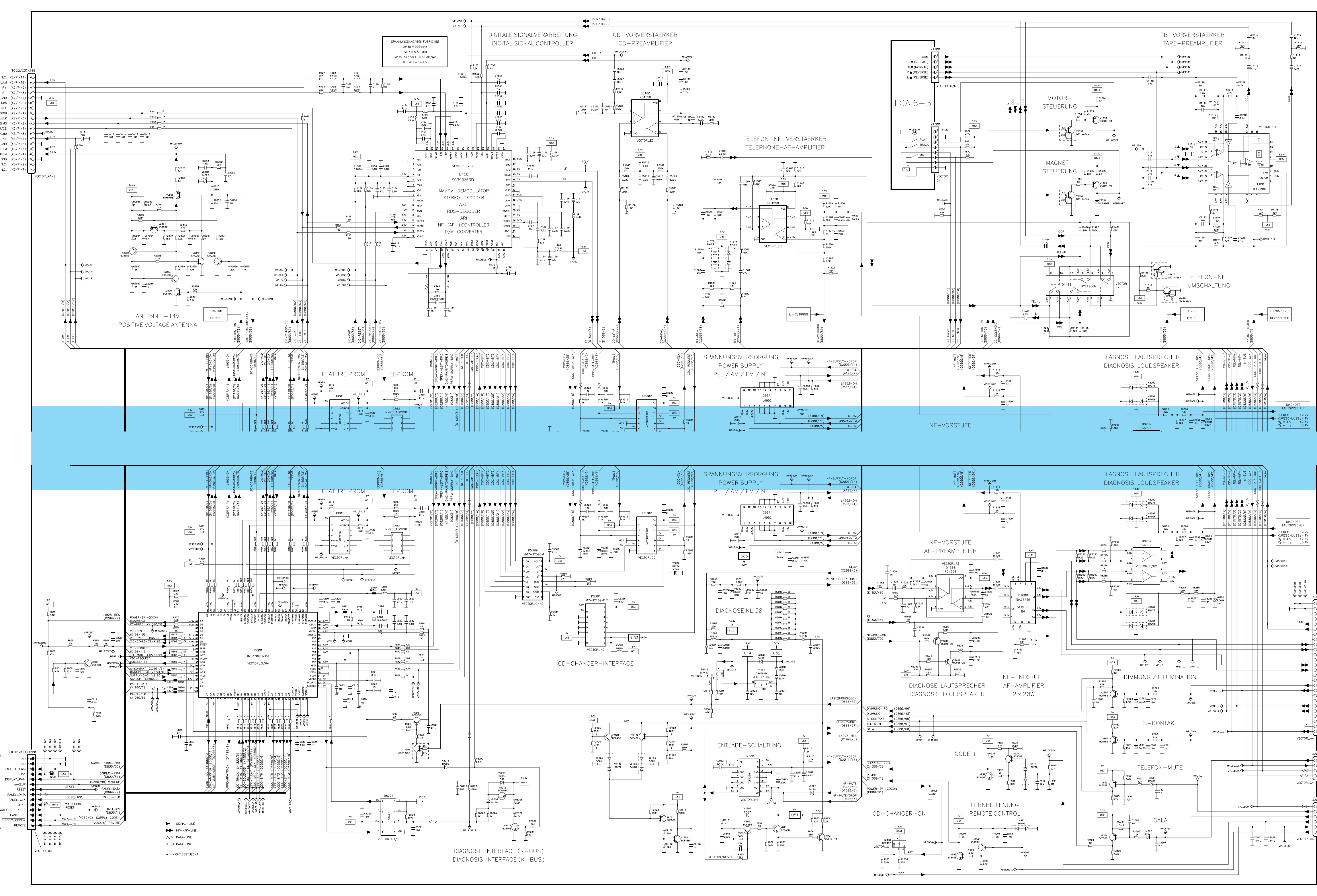

ANSCHLUSSTAFEL
CONNECTOR BOARD

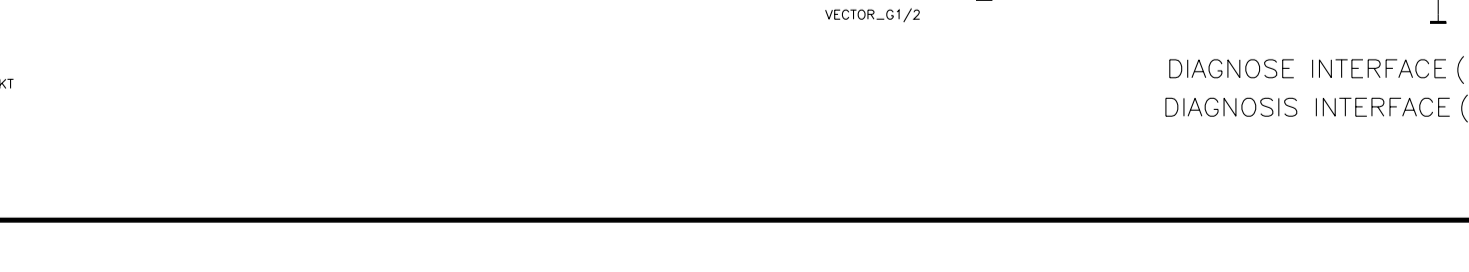
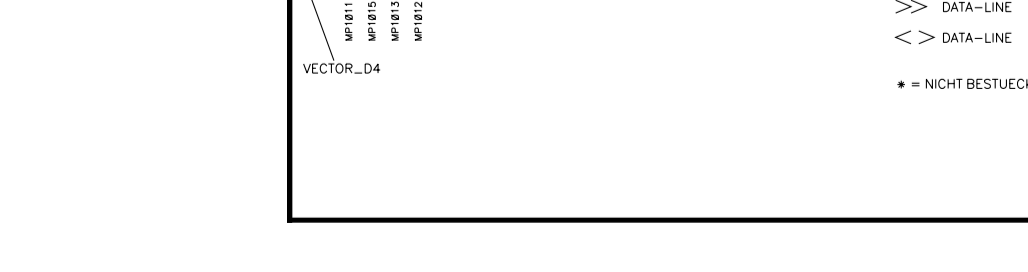

Pin-Belegung des IC D150
Digital IC D150 Pin Configuration

Pin No.	I/O	Name	Funktion	Function
1	-	VSS	Masse	Ground
2	-	VDD	5 V	5 V
4	I	TDI	Testdateneingang	Test Data Input
5	I	TMS	Test Mode	Testmode
6	I	TCKL	Test Clock	Testclock
7	-	VDD	5 V	5 V
8	-	VSS	Masse	Ground
9	-	PWDN	Power down Zustand	Power down Mode
10	I	RESN	Reset	Hardware reset (active LOW)
11	O	IRQN	RDS Alarm/SLS	RDS alarm/search stop
12	I	CSN	Chip select Eingang	Chip select µC interface
13	I	SCRPRX	Serielle Daten µC Interface	Serial data µC interface IN
14	O	SCPTX	Serielle Daten µC Interface	Serial data µC interface OUT
15	I	SCPCK	Clock µC Interface	Clock µC interface
16	-	VDDIO	Plusspannung Digitale Ein-/Ausgänge	Plusspannung Digitale Ein-/Ausgänge
17	-	VSSIO	Masse Digitale Ein-/Ausgänge	Ground for digital I/O
18	O	CKL1	Programmierbarer Clock 1	Programmable clock 1
20	I	XTALI	28,5 MHz Oszillator	Oscillator 28,5 MHz
21	O	XTALO	28,5 MHz Oszillator	Oscillator 28,5 MHz
31	I	TDI1	Testdateneingang 1	Test Input 1
32	-	VDD	5 V	5 V
33	-	VSS	Masse	Ground
35	-	VSSPLL	Masse (Minus) PLL	Ground (minus) PLL
36	-	VDDPLL	Plus PLL 5V	PLL 5V (pos.)
37	O	REFP1	Audio D/A-Wandler Positive Referenz	Audio D/A converter (pos. reference)
38	O	REFN1	Audio D/A-Wandler Negative Referenz	Audio D/A converter (neg. reference)
39	-	CAPN	PLL Kapazität (negativ)	PLL capacity (neg.)
40	-	CAPP	PLL Kapazität (positiv)	PLL capacity (pos.)
41	-	VDDO	Audio D/A - Wandler 5V	Audio D/A converter (+5V)
42	-	VSSO	Audio D/A - Wandler Masse	Audio D/A converter (ground)
44	O	RFO	Audio Rechts (analog)	Analogic audio right
45	-	OGND	Masse Analogausgänge	Ground
46	-	LFO	Audio Links (analog)	Analogic audio left
48	-	VDDA	5V A/D - Wandler	5V A/D - converter
49	-	VSSA	Masse A/D - Wandler	Ground A/D - converter
50	O	REFP3	Audio D/A-Wandler Positive Referenz	Audio D/A converter (pos. reference)
51	O	REFN3	Audio D/A-Wandler Negative Referenz	Audio D/A converter (neg. reference)
52	I	AUXL	Externer Eingang links	Auxiliary left
53	I	CCL	Cassette Eingang links	Cassette input left
54	-	AGND	Audioeingänge Masse	Ground for Audio inputs
55	I	CCR	Cassette Eingang rechts	Cassette input right
56	I	AUXR	Externer Eingang rechts	Auxiliary left right
57	-	VDDR	5 V	5 V
58	-	VSSR	Masse	Ground
59	O	REFP2	Audio D/A-Wandler Positive Referenz	Audio D/A converter (pos. reference)
60	I	IFP	ZF Eingang (plus)	Positif IF input
61	I	IFN	ZF Eingang (minus)	IF input (neg.)
62	O	REFN2	Audio D/A-Wandler Negative Referenz	Audio D/A converter (neg. reference)
63	-	VSSIF	ZF A/D - Wandler (minus)	IF A/D converter (-)
64	-	VDDIF	ZF A/D - Wandler 5 V	IF A/D converter (+5V)

Pin-Belegung des FM/AM Tuner-IC D1				
Tuner IC D1 Pin configuration				
Pin No.	I/O	Name	Funktion	Function
1	-	MIXDEC	Mischer Entkopplung	Mixer decoupling
2	-	CINT	für PLL	for PLL
3	-	CHOLD	für PLL	for PLL
4	-	PLL_GND	PLL - Masse	PLL Ground
5	-	VCC	8,5V	8,5V
6	-	VPLL	PLL Oberspannung	PLL top voltage
7	I	LFINP	Schleifenfiltereingang	PLL loop filter Input
8	O	LF1	Schleifenfilter 1	PLL loop filter Output 1
9	O	LF2	Schleifenfilter 2	PLL loop filter Output 2
10	O	LF3	Schleifenfilter 3	PLL loop filter Output 3
11	I	VTUNE	Abstimmspannung	Tuning voltage
12	I	OSCINP	Oszillator Eingang	Oscillator Input
13	O	OSCOUT	Oszillator Ausgang	Oscillator Output
14	-	OSCGND	Oszillator Masse	Oscillator Ground
15	O	VCC	8,5V	8,5V
16	O	OSCBUF	Oszillatorausgangstreiber	Oscillator Buffer Output
17	I	DGND	Digitale Masse	Digital Ground
18	I	CS	Chip Select	Chip Select
19	I	RD	Dateneingang	DATA IN
20	I	CLK	Clock	Clock
21	O	TX	Datenausgang	DATA OUT
22	I	FREF	Referenzfrequenz	Reference frequency
23	-	IFAGC2	ZF Regelspannung 2	IF AGC 2
24	O	IFOUT1	ZF - Ausgang 1	IF output 1
25	O	IFOUT2	ZF - Ausgang 2	IF output 2
26	-	IFAGC1	ZF Regelspannung 1	IF AGC 1
27	-	IFGND	ZF Masse	IF Ground
28	I	IFIN	ZF Eingang	IF Input
29	-	VDC	Interne Referenzspannung	Internal reference voltage
30	-	VCC	8,5V	8,5V
31	O	MIXOUT2	Mischer Ausgang 2	Mixer Output 2
32	O	MIXOUT1	Mischer Ausgang 1	Mixer Output 1
33	-	AMREF	AM - Referenzeingang	AM reference Input
34	I	AMMIXIN	AM Mischereingang	AM Mixer Input
35	-	RFAGC3	HF Regelzeitkonstante (aufregeln)	RF AGC 3
36	O	RFAGCAM	HF Steuerspannung Vorstufe AM	RF AGC for AM input stage
37	O	RFAGCFM	HF Steuerspannung Vorstufe FM	RF AGC for FM input stage
38	-	MIXGND	Mischer Masse	Mixer Ground
39	-	RFAGC2	HF Regelzeitkonstante (Detektor)	RF AGC 2
40	-	RFAGC1	HF Regelzeitkonstante (abregeln)	RF AGC 1
41	-	ANGGND	Analog Masse	Analog ground
42	-	FMMIXREF	Referenzspannung FM Mischer	Reference voltage FM mixer
43	I	FMMIXINP	FM Mischer Eingang	FM mixer input
44	-	RFAGCD	AGC Entkopplung	AGC decoupling

Prüfdiagnose Tuner IC (D1)						
Diagnosis test tuner IC (D1)						
Pin	Band	Frequenz	E'	Uss	Vermerke	Notice
24+25 (ZF-OUT)	FM	97,1 MHz	83 dbµV	650 mVss	jeweils gegen Masse	respective against GND
28	FM	97,1 MHz	80 dbµV	25 mVss		
31+32	FM	97,1 MHz	80 dbµV	200 mVss	jeweils gegen Masse	respective against GND
31+32	AM	900 kHz	80 dbµV	200 mVss	jeweils gegen Masse	respective against GND
34 (AM-IN)	AM	900 kHz	80 dbµV	50 mVss		
36	AM	900 kHz	ab 73 dbµV		künstliche Antenne aus	not commutated
37	FM	97,1 MHz	ab 80 dbµV			

HF-Platte
RF board
PL 0172 A04

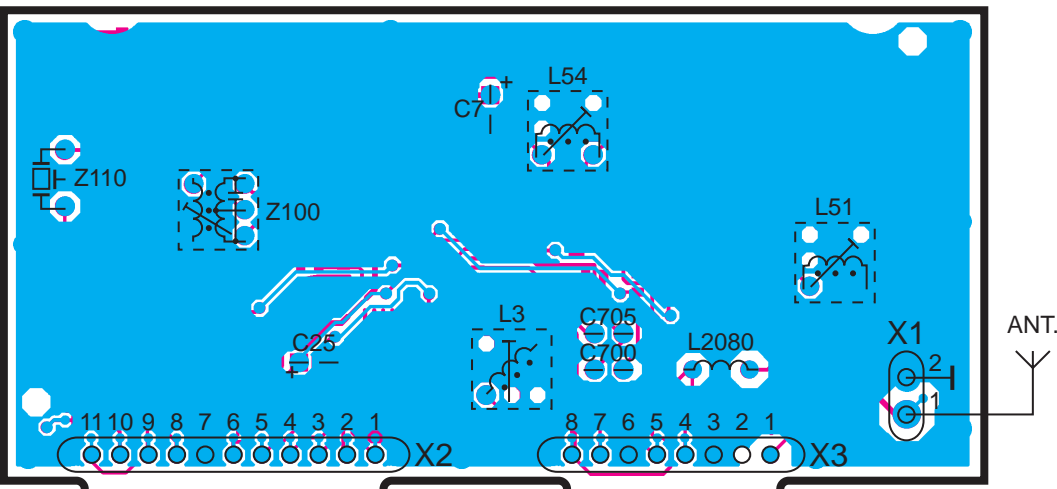

- X2 (TO A100)**
- 1 = CF400 / CS
 - 2 = SPL_2_SIMO
 - 3 = SPL_2_CLK
 - 4 = SPL_2_SOMI
 - 5 = F_REF
 - 6 = U85 (8,5V)
 - 7 = GND
 - 8 = IF-
 - 9 = IF+
 - 10 = U_AM (8,3V)
 - 11 = N.C.

- X3 (TO A100)**
- 1 = MP_ANT
 - 2 = N.C.
 - 3 = GND
 - 4 = +PHANTOM (14V)
 - 5 = U_FM (8,4V)
 - 6 = GND
 - 7 = U_PLL (9,7V)
 - 8 = MP_dU

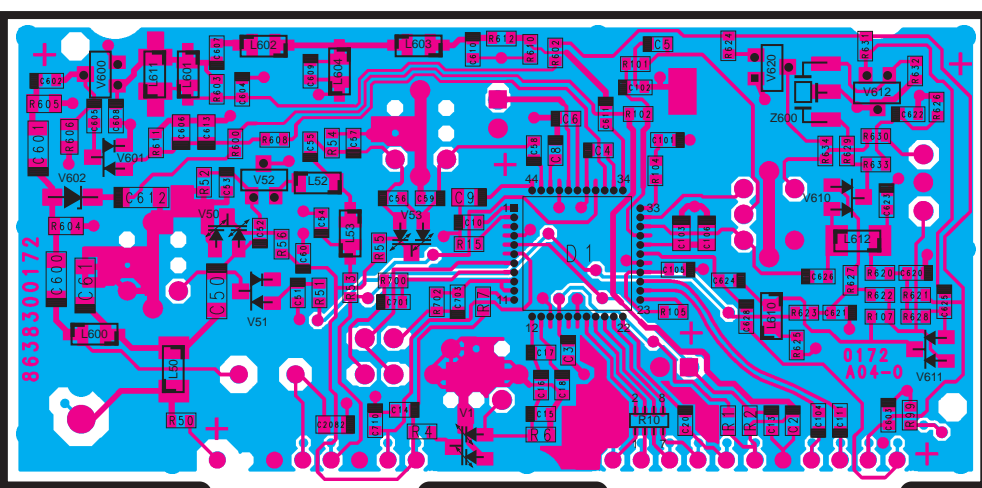

HF-Platte
RF board
PL 0172 A04
Chip

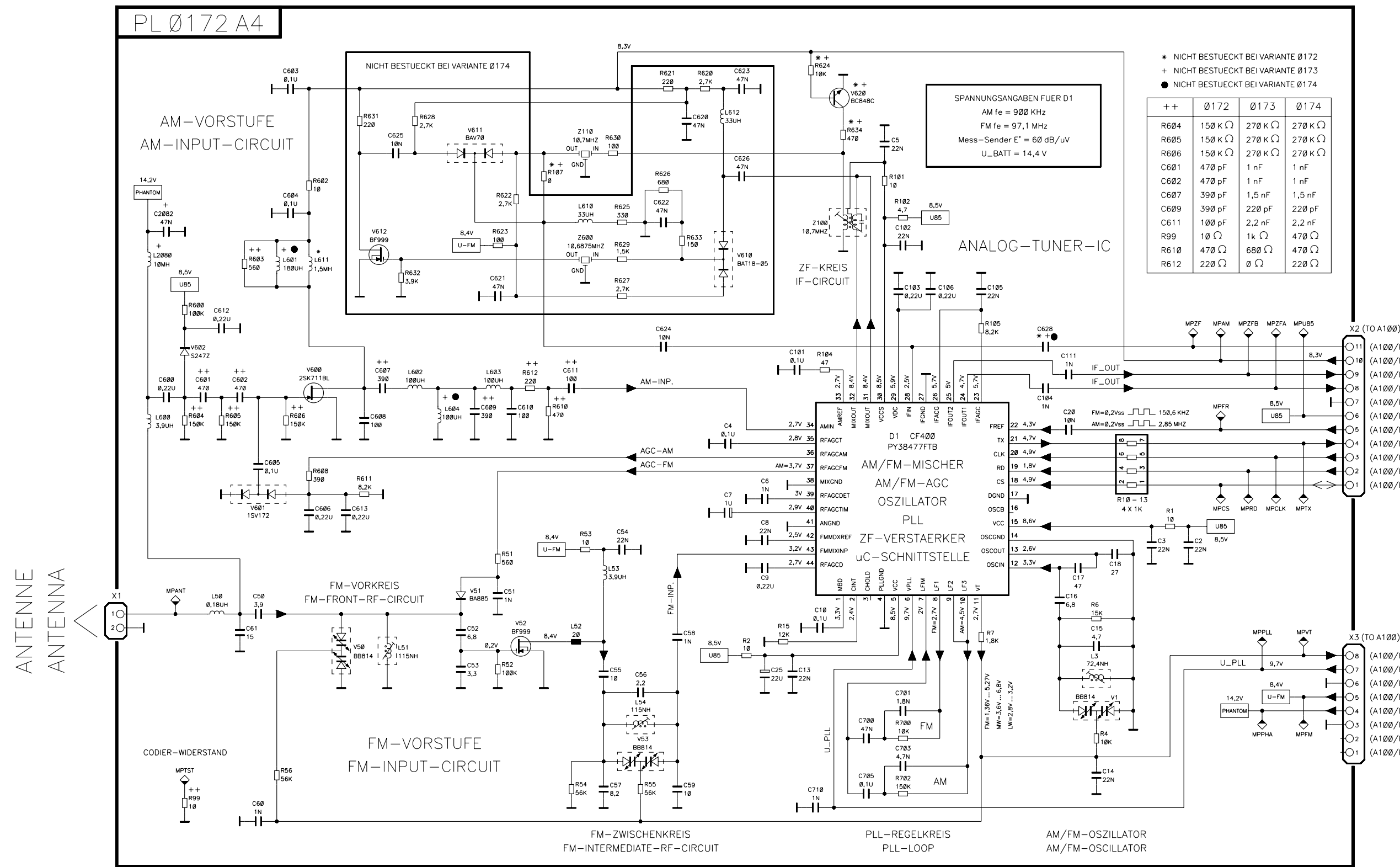

SPANNUNGSANGABEN FUER D1
AM fe = 900 KHz
FM fe = 97,1 MHz
Mess-Sender E' = 60 dBµV
U_BATT = 14,4 V

++	0172	0173	0174
R604	150 k Ω	270 k Ω	270 k Ω
R605	150 k Ω	270 k Ω	270 k Ω
R606	150 k Ω	270 k Ω	270 k Ω
C601	470 pF	1 nF	1 nF
C602	470 pF	1 nF	1 nF
C607	390 pF	1,5 nF	1,5 nF
C609	390 pF	220 pF	220 pF
C611	100 pF	2,2 nF	2,2 nF
R919	18 Ω	1k Ω	470 Ω
R618	470 Ω	680 Ω	470 Ω
R612	220 Ω	0 Ω	220 Ω

HAUPTPLATE
MAIN BOARD