

● BLAUPUNKT

**AUTORADIO
T3/F4 ASB EU**

T-Line 3 CR

Ravenna C32

7 642 115 310

Dublin C32

7 642 120 310

Boston C32

7 642 125 510

Louisiana DJ32

7 642 121 310/9

Minnesota DJ32

7 642 141 310/9

Florida DJ32

7 642 166 310/9

T-Line 3 CD

Kiel CD32

7 642 171 310

Porto CD32

7 642 172 310

Alicante CD32

7 642 174 310

San Remo CD32

7 642 176 310

Santa Cruz CD32

7 642 178 310

Funline 4

Bologna C52

7 642 210 310

Carolina DJ52

7 642 410 310/9

Modena CD52

7 642 260 310

Valencia CD52

7 642 262 310

8 622 403 462 BN 02/03

**CLASS 1
LASER PRODUCT**



**UNSICHTBARE LASERSTRAHLUNG
NICHT DEM STRAHL AUSSETZEN
LASER CLASS 3B**



• Serviceanleitung / • Service Manual

**Abgleich und Programmierungen nur mit Softwaretool (ComServer) möglich
All alignment and programming steps can only be carried out with the ComServer
software tool.**

(D) VORSICHT!

**Die CD-Geräte beinhalten eine Laserkomponente!
Im Servicefall bitte nachfolgende Hinweise
beachten:**

- Das Gerät arbeitet mit einem unsichtbaren Laserstrahl.
- Bei geöffnetem Gerät tritt im Bereich des Plattenfaches Laserstrahlung aus.
- Nicht in den Strahl blicken.
- Unbeteiligte Personen vom Arbeitsplatz fernhalten.
- Der Betrachtungsabstand darf 13 cm nicht unterschreiten.
- Kann dies nicht eingehalten werden, muss eine geeignete Laserschutzbrille getragen werden.

(GB) CAUTION!

**The CD units are equipped with a laser component!
For servicing make sure to observe the following
instructions:**

- The unit operates with invisible laser beams.
- When the cover is removed, invisible laser beams are emitted near the disc compartment.
- Avoid direct eye contact with these beams.
- Keep unauthorised persons away from the workbench.
- The viewing distance should not be less than 13 cm.
- If this distance cannot be kept, use suitable laser safety goggles.

Main Feature list Funline4

Features	Modena CD52	Valencia CD52	Bologna C52 Carolina DJ52
FM-Preset	2x6	2x6	2x6
MW-Preset	1x6	1x6	1x6
LW-Preset	1x6	1x6	1x6
FMT	1x6	1x6	1x6
HICUT	√	√	√
lo/dx	3/3	3/3	3/3
Mechanism CC			TN708
Dolby B			√
Metal			√
S-CPS			√
Repeat			√
Radio Monitor			√
Mechanism CD	BP4R/3	BP4R/3	
Track Mix	√	√	
Track Repeat	√	√	
Track Scan	√	√	
Mute	√	√	√
X-Bass	3 steps	3 steps	3 steps
Preamp	4 x 2V	4 x 2V	4 x 2V
Source Tone Memory	√	√	√
Telephone Input	√	√	√
AUX IN	√	√	√
Radio Mute	√	√	√
Display	negative	negative	negative
Flip Panel	√	√	√
DMS	ASCII	ASCII	ASCII
Dimmer	√	√	√
IR RC08	optional	optional	optional
Peak Level Meter	√	√	√
Clock	√	√	√
Release Panel	√	√	√
Running Text	√	√	√
ETUI	√	√	√
CDC-A08; IDC-A09	ASCII	ASCII	ASCII

Main Feature list T-Line3

Features	Dublin C32 Louisiana DJ32	Boston C32 (blue)	Ravenna C32 Florida DJ32	Minnesota DJ32	Kiel CD32	Porto CD32	Alicante CD32 (blue)	San Remo CD32	Santa Cruz Edition CD32
FM-Preset	2x6	2x6	2x6	2x6	2x6	2x6	2x6	2x6	2x6
MW-Preset	1x6	1x6	1x6	1x6		1x6	1x6	1x6	1x6
LW-Preset	1x6	1x6	1x6	1x6		1x6	1x6	1x6	1x6
FMT	1x6	1x6	1x6	1x6	1x6	1x6	1x6	1x6	1x6
HICUT	√	√	√	√	√	√	√	√	√
lo/dx	3/3	3/3	3/3	3/3	3/3	3/3	3/3	3/3	3/3
Mechanism CC	ADC 1400	ADC 1400	ADC 1400	TN708					
Dolby	-	-	-	B					
Metal	-	-	-	√					
S-CPS	-	-	-	√					
Repeat	-	-	-	√					
Mechanism CD					BP4-R	BP4-R	BP4-R	BP4-R	BP4-R
Track Mix					√	√	√	√	√
Track Repeat					√	√	√	√	√
Track Scan					√	√	√	√	√
X-Bass	3 steps	3 steps	3 steps	3 steps	3 steps	3 steps	3 steps	3 steps	3 steps
Preamp	4 x 2V	4 x 2V	4 x 2V	4 x 2V	4 x 2V	4 x 2V	4 x 2V	4 x 2V	4 x 2V
DMS, CDC-A08; IDC-A09	ASCII	ASCII	ASCII	ASCII	ASCII	ASCII	ASCII	ASCII	ASCII
AUX IN	√	√	√	√	√	√	√	√	√
Line Out	√	√	√	√	√	√	√	√	√
Tel/Nav In									√
Radio Mute	√	√	√	√	√	√	√	√	√
IR Remote Control RC08	optional	optional	optional	optional	optional	optional	optional	optional	optional
Peak Level Meter	√	√	√	√	√	√	√	√	√
Clock manual 12/24 hours	√	√	√	√	√	√	√	√	√
Facia colour	black	black	black	black	black	black	black	black	titanium
Night Design	amber	red	amber	red	amber	amber	red	red	red
Iso Connector 36 pins	√	√	√	√	√	√	√	√	√
Release Panel	√	√	√	√	√	√	√	√	√

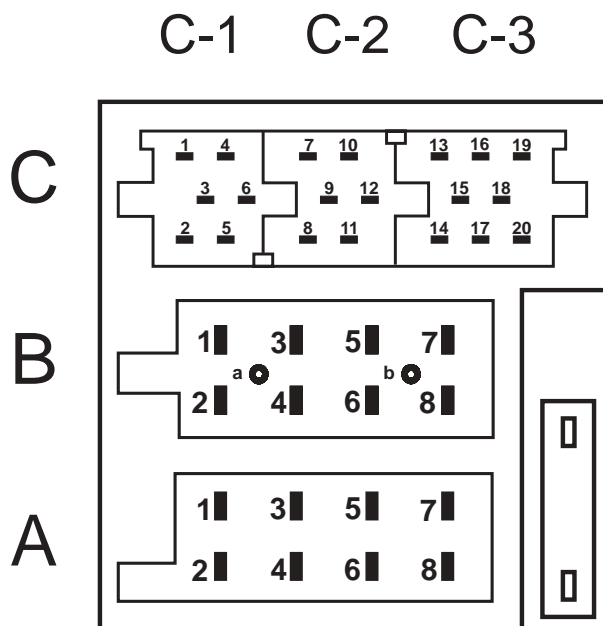

A		B	
1	NC	1	Speaker Out (RR +) 4Ω
2	Telephone mute <2volts = active; open = not active	2	Speaker Out (RR -) 4Ω
3	NC	3	Speaker Out (RF +) 4Ω
4	Permanent plus (KL 30); 10 A	4	Speaker Out (RF-) 4Ω
5	Automatic antenna	5	Speaker Out (LF +) 4Ω
6	Illumination, active high (3 - 12 volts)	6	Speaker Out (LF-) 4Ω
7	Ignition plus, (KL 15) <2.5volts = Ign.off; >7volts = Ign.on	7	Speaker Out (LR +) 4Ω
8	Ground	8	Speaker Out (LR-) 4Ω
a	MAUS-BUS-OUT (TXD) <0.5volts = logic 0; >3.5volts = logic 1		
b	MAUS-BUS-IN (RXD) <1volt = logic 0; >3.5volts = logic 1		

(+*) Nur Funline 4 Geräte / (+*) only Funline 4 units
 (**) Nur Funline 4 Geräte und Santa Cruz / (***) only Funline 4 units and Santa Cruz

C					
	C1		C2		C3
1	Line out, 3V/10kΩ (LR)	(*)7	Tel.-/Navi. AF In 10V/560Ω	13	CD-Changer ASCII IN / (+)TMC-Out <1volt = logic 0; >3.5volts = logic 1
2	Line out, 3V/10kΩ (RR)	(*)8	Tel.-/Navi. AF In 10V/560Ω	14	CD-Changer ASCII OUT / (+)TMC-Out <0.5volt = logic 0; >3.5volts = logic 1
3	Line out ground	9	NC	15	CDC permanent plus (bloc A / pin 4)
4	Line out out, 3V/10kΩ (LF)	10	+12 V switched	16	+12 V switched
5	Line out out, 3V/10kΩ (RF)	11	Remote control PWM <1volt = logic 0; >3.5volts = logic 1	17	CD-Changer I ² C-Bus Masse / Gnd.
6	+12 V switched	12	Remote control Ground	18	Aux Ground
				19	Aux input 2V/6kΩ (L)
				20	Aux input 2V/6kΩ (R)

(D) Abgleichhinweise

Der Abgleich erfolgt nur noch elektronisch über den PC (ComServer). Es dürfen keine Filter abgeglichen werden. Nach dem Tausch eines Filters, muss der Abgleich über den PC erfolgen.

Wellenbereich:

FM = 87,5 MHz - 108,0 MHz (100 kHz automatische Suchlaufschritte) (50 kHz manuelle Suchlaufschritte)
MW = 531 kHz - 1602 kHz (9 kHz automatische Suchlaufschritte) (9 kHz manuelle Suchlaufschritte)
LW = 153 kHz - 279 kHz (9 kHz automatische Suchlaufschritte) (1 kHz manuelle Suchlaufschritte)

Vorbereitende Arbeiten

Bevor Sie den elektrischen Abgleich durchführen, müssen Sie folgende Vorbereitungen treffen:

Höhen - Einstellung	0
Bass - Einstellung	0
Fader - Einstellung	0
Balance - Einstellung	0
HICUT (Menü, nur Funline 4)	0
X-Bass - Einstellung (Menü)	OFF

Lautsprecheranschluß

Der Lautsprecherausgang muß mit 4 Ω abgeschlossen sein.

Demomode

Demomode aktivieren

1. Schalten Sie das Autoradio aus.
2. Betätigen Sie die Tasten **1 + 6** gleichzeitig und halten Sie die Tasten gedrückt.
3. Schalten Sie das Gerät ein und halten Sie die Tasten noch für ca. 1 Sekunde gedrückt.

Nach diesem Schritt erscheint im Display nach "BLAUPUNKT" der Schriftzug "DEMO".

Demomode deaktivieren

Sie verlassen den Servicemode durch Ausschalten des Autoradios. Wiederholen Sie bitte den Schritt 1-3 um den Demomode zu verlassen.

Software Version Hauptprozessor und Kappenprozessor

Testmode aktivieren

1. Schalten Sie das Autoradio aus.
2. Betätigen Sie die Tasten **1 + 2** gleichzeitig und halten Sie die Tasten gedrückt.
3. Schalten Sie das Gerät ein und halten Sie die Tasten noch für ca. 1 Sekunde gedrückt.

Das Autoradiodisplay zeigt 8 Zeichen an. Die 4 linken Zeichen zeigen den Softwarestand des Hauptprozessors an und die 4 rechten Zeichen zeigen den Softwarestand des Kappen- Prozessors an.

Testmode deaktivieren

Sie verlassen den Service Mode durch Ausschalten des Autoradios.

(GB) Notes on alignment

The alignment is always done electronically using a PC (ComServer). Do not align any filters. If a filter has been replaced, align the unit with the PC.

Waveband:

FM = 87.5 MHz - 108.0 MHz (100 kHz automatic search steps) (50 kHz manual search steps)
MW = 531 kHz - 1602 kHz (9 kHz automatic search steps) (9 kHz manual search steps)
LW = 153 kHz - 279 kHz (9 kHz automatic search steps) (1 kHz manual search steps)

Preparatory steps

Observe the following preparations before performing the electrical alignment:

Treble adjustment	0
Bass adjustment	0
Fader adjustment	0
Balance adjustment	0
HICUT (menu, only Funline 4)	0
X-Bass adjustment (DSC menu)	OFF

Loudspeaker connections

The loudspeaker output must be terminated with 4 Ω .

Demo mode

Activating the Demo mode

1. Switch the unit off.
2. Press the push-buttons **1 + 6** simultaneously and hold them depressed.
3. Switch the unit back on and hold on to the buttons for approximately one more second.

Following this step, the display will show the wording "BLAU-PUNKT" followed by "DEMO".

Deactivating the Demo mode

You can quit the service mode by switching the radio off. To quit the demo mode, repeat step 1-3.

Software version main processor and panel processor

Activating the test mode

1. Switch the unit off.
2. Press the push-buttons **1 + 2** simultaneously and hold them depressed.
3. Switch the unit back on and hold on to the buttons for approximately one more second.

The car radio display shows 8 characters. The left 4 characters indicate the software version of the main processor, the right 4 characters indicate the software version of the panel processor.

To exit the test mode

You can quit the service mode by switching the radio off.

Modena CD52

7 642 260 310

Valencia CD52

7 642 262 310

Bologna C52

7 642 210 310

Carolina DJ52

7 642 410 319

Alicante CD32

7 642 174 310

Porto CD32

7 642 172 310

Kiel CD32

7 642 171 310

San Remo CD32

7 642 176 310

Santa Cruz CD32

7 642 178 310

Dublin C32

7 642 120 310

Boston C32

7 642 125 310

Ravenna C32

7 642 115 310

Louisiana DJ32

7 642 121 319

Florida DJ32

7 642 166 319

Minnesota DJ32

7 642 141 319

8 622 403 366 BN-ST 04/03

Schaltbild • Circuit diagram**CLASS 1
LASER PRODUCT****UNSICHTBARE LASERSTRAHLUNG
NICHT DEM STRAHL AUSSETZEN
LASERKLASSE 3B****(D) VORSICHT!****Die Geräte beinhalten eine Laserkomponente!
Im Servicefall bitte nachfolgende Hinweise
beachten:**

- Das Gerät arbeitet mit unsichtbarem Laserstrahl.
- Bei geöffnetem Gerät tritt im Bereich des Plattenfaches Laserstrahlung aus.
- Nicht in den Strahl blicken.
- Unbeteiligte Personen vom Arbeitsplatz fernhalten.
- Der Betrachtungsabstand darf 13 cm nicht unterschreiten.
- Kann dies nicht eingehalten werden, muß eine geeignete Laserschutzbrille getragen werden.

(GB) CAUTION!**The CD units are equipped with a laser component!
For servicing make sure to observe the following
instructions:**

- The unit operates with invisible laser beams.
- When the cover is removed, invisible laser beams are emitted near the disc compartment.
- Avoid direct eye contact with these beams.
- Keep unauthorised persons away from the workbench.
- The viewing distance should not be less than 13 cm.
- If this distance cannot be kept, use suitable laser safety goggles.

REMARK : * = "Section/Component In Use"

	T - LINE 3						FUNLINE 4	
	Boston C32 Dublin C32 Ravenna C32 Louisiana DJ32 Florida DJ32	Minnesota DJ32	Alicante CD32 Porto CD32 San Remo CD32	Kiel CD32	Santa Cruz CD32	Bologna C52 Carolina DJ52	Modena CD52 Valencia CD52	
AM	X	X	X		X	X	X	
CASSETTE PREAMP	X							
CASS-MUTE	X							
TN708 INTERFACE		X				X		
CD BUFFER			X	X	X		X	
S800						X	X	
H1091,R1091 & V1091						X	X	
DIMMER						X	X	
D5300	BC369	BC369	LM317T	LM317T	LM317T	BC369	LM317T	
V2010	BC369	BC369	BD436	BD436	BD436	BC369	BD436	
TEL input		X			X	X	X	
R5302/R5303			X	X	X		X	
R1300	X	X				X		
R5304	3,3K	3,3K	470R	470R	470R	3,3K	470R	
R5305	3,3K	3,3K				3,3K		
R5306			X	X	X		X	
R5307			X	X	X		X	
R1304	68K	68K	10R	10R	10R	68K	10R	
R1305	X	X				X		
R1301/R1302/R1303	X							
X1300	X							
R5207/5208/5209			X	X	X		X	
L5200/X5200			X	X	X		X	
C304/R306/R307/R326	X	X	X		X	X	X	
D5301/C840			X	X	X		X	
R840/R841	X	X				X		
C2040	47uF	47uF	2200uF	2200uF	2200uF	47uF	2200uF	
R1505/R1506	OPEN	10K	10K	10K	10K	10K	10K	
R2036..... R2040			X	X	X		X	
R2015/R2017/V2022	X	X	X		X	X	X	

HAUPTPLATTE MAIN BOARD

Blockschaltbild Block diagram

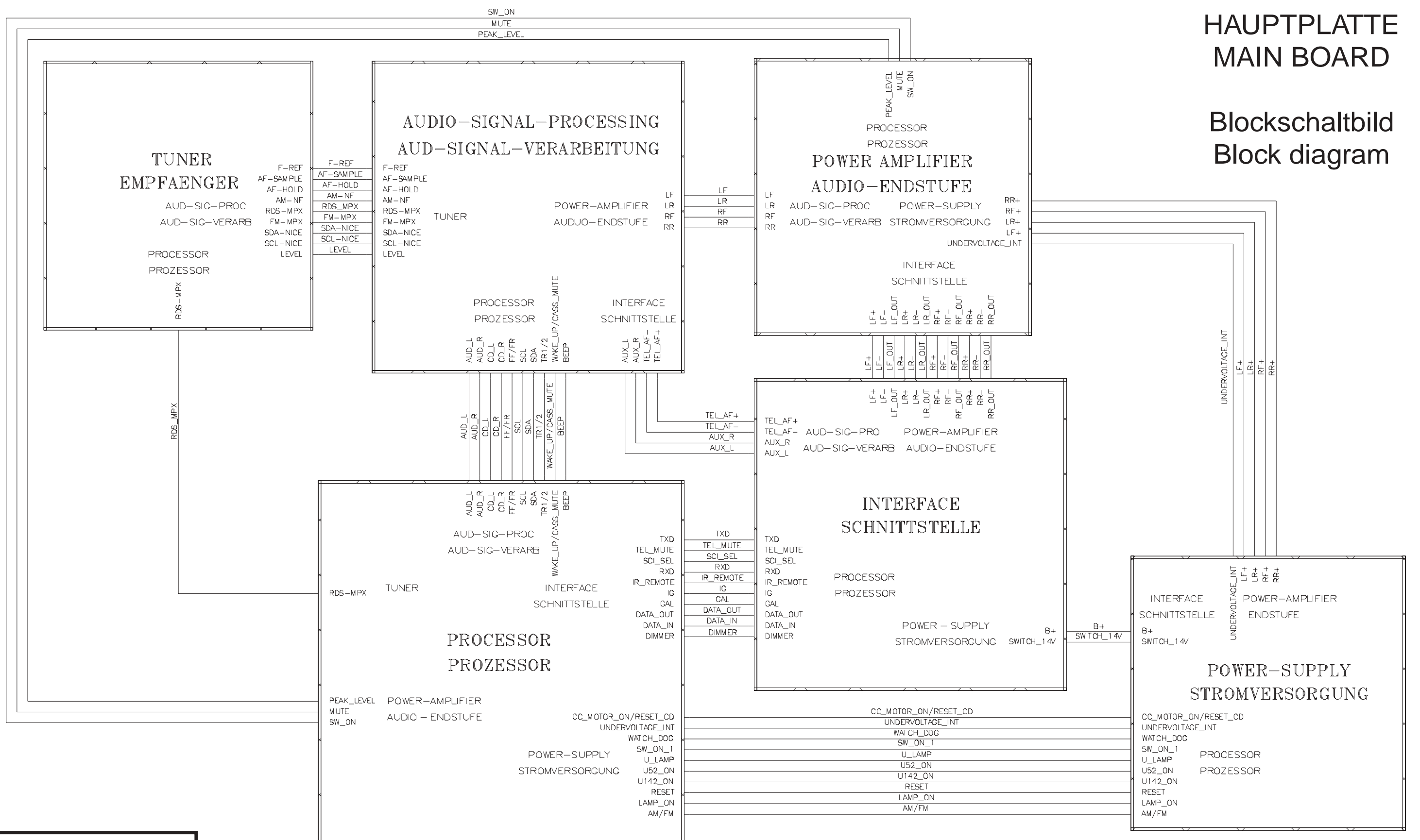

PL 4604 D06

HAUPTPLATTE MAIN BOARD

Audio Signal Verarbeitung / Audio signal processing

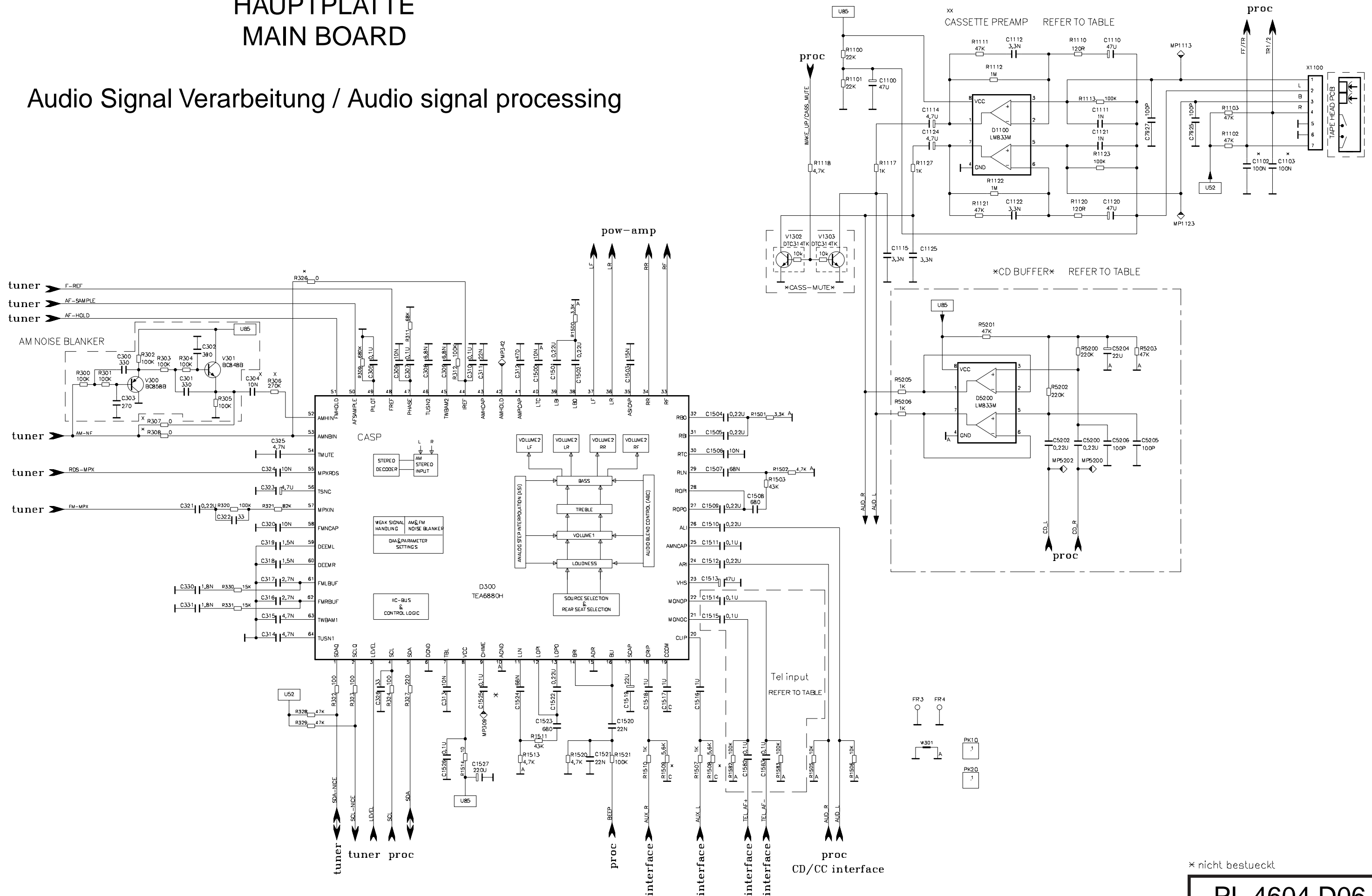

× nicht bestückt

PL 4604 D06

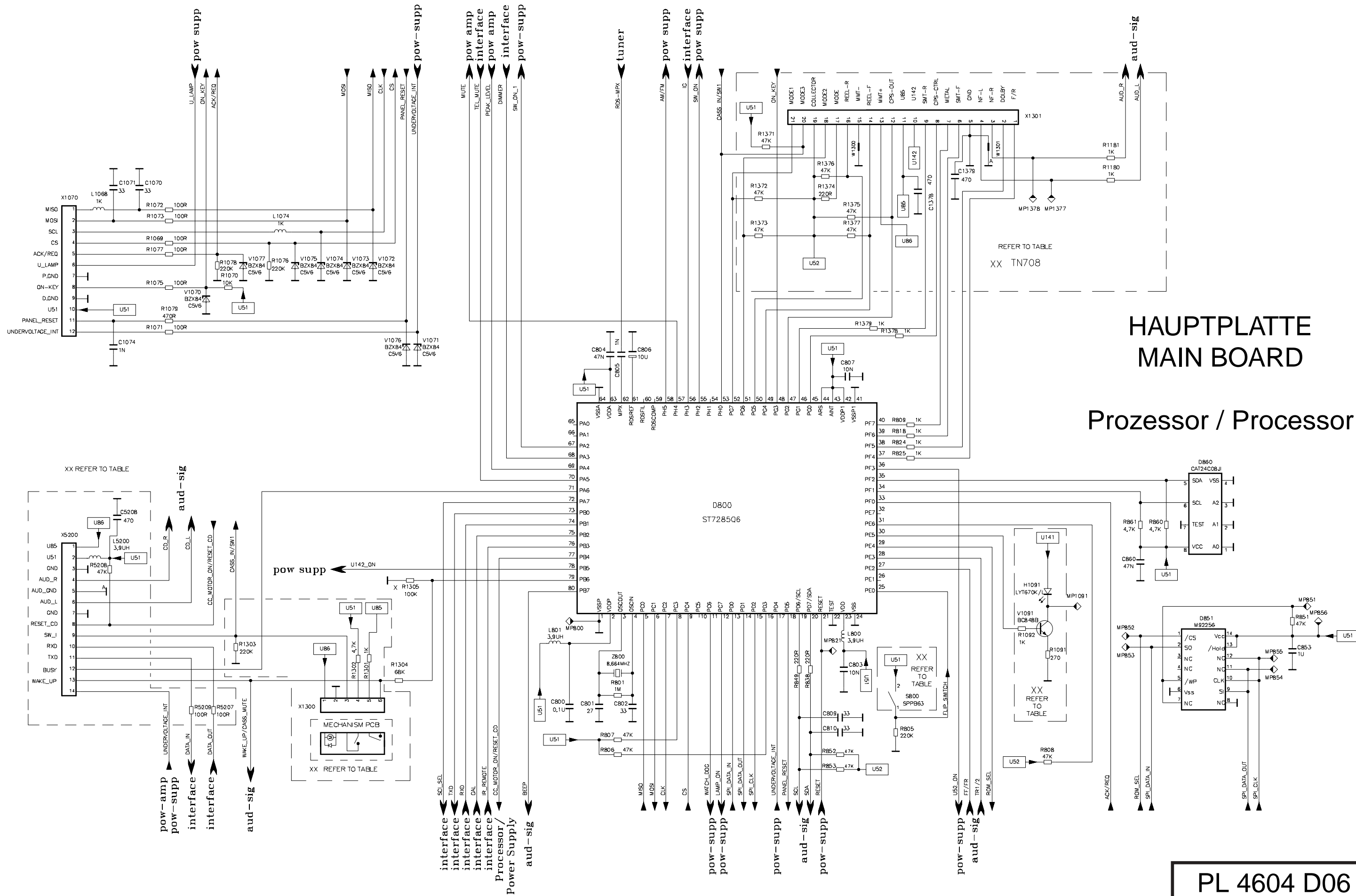

HAUPTPLATTE MAIN BOARD

Prozessor / Processor

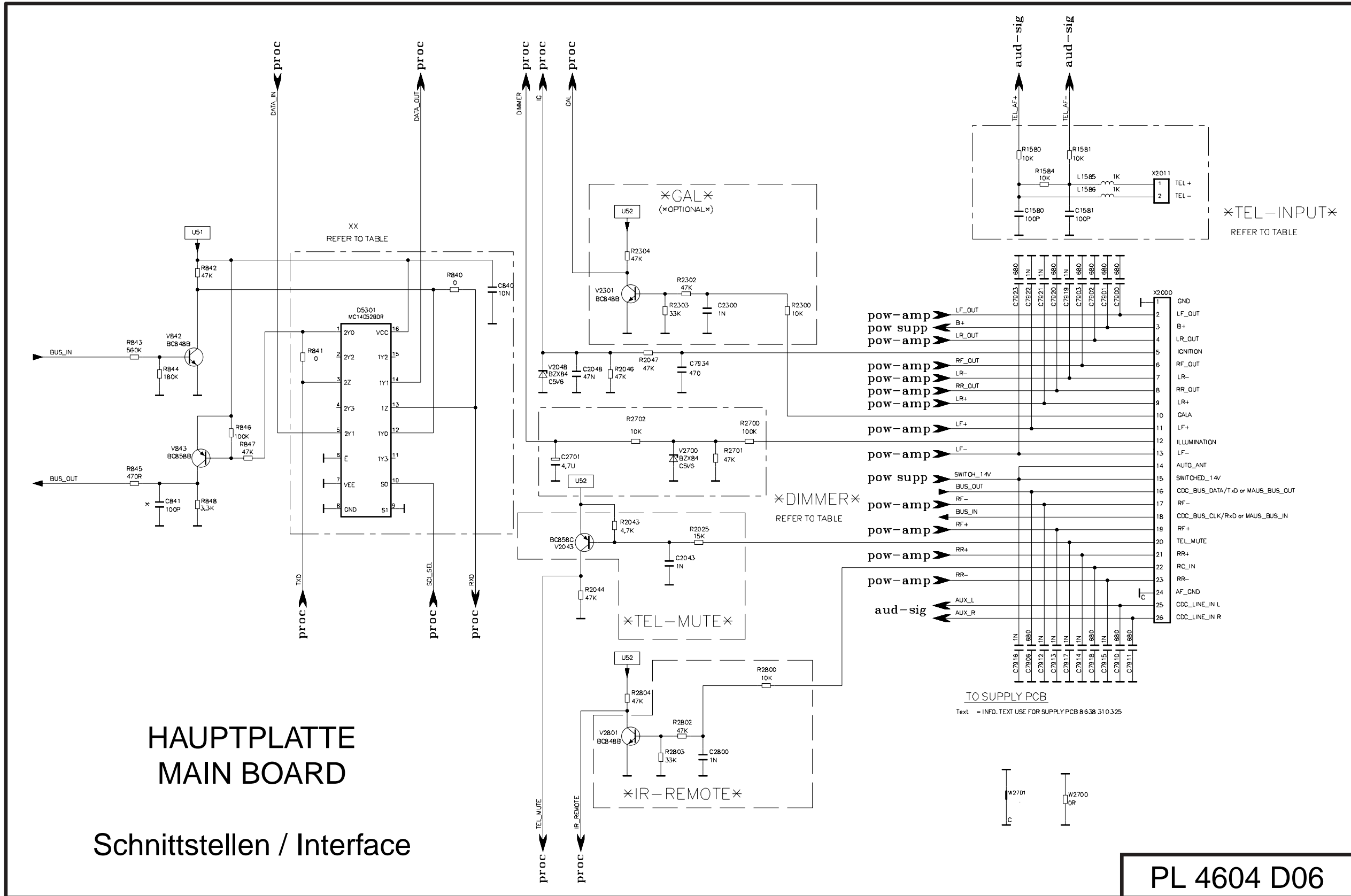

**HAUPTPLATTE
MAIN BOARD**

Schnittstellen / Interface

PL 4604 D06

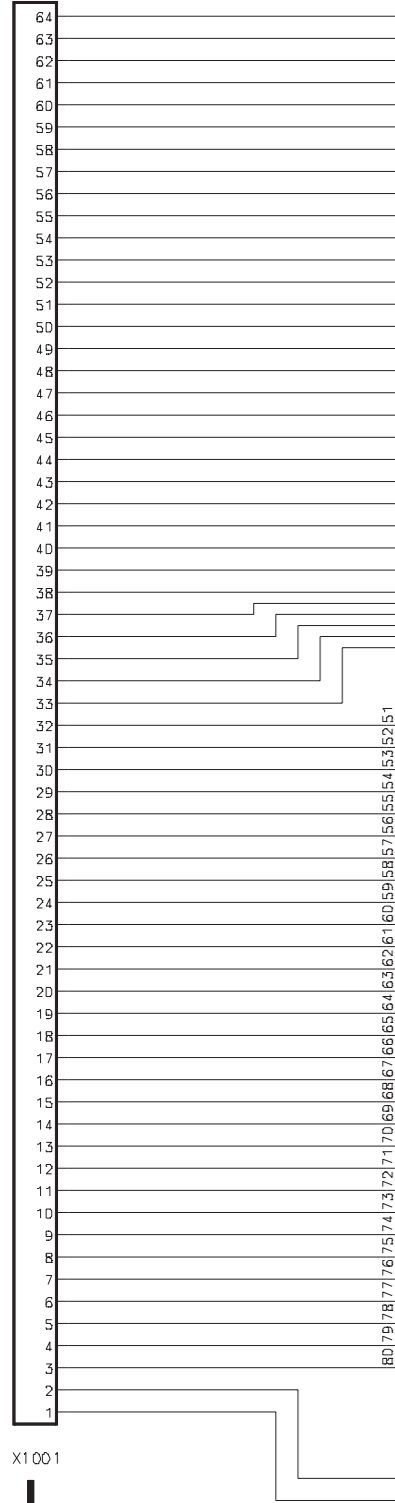
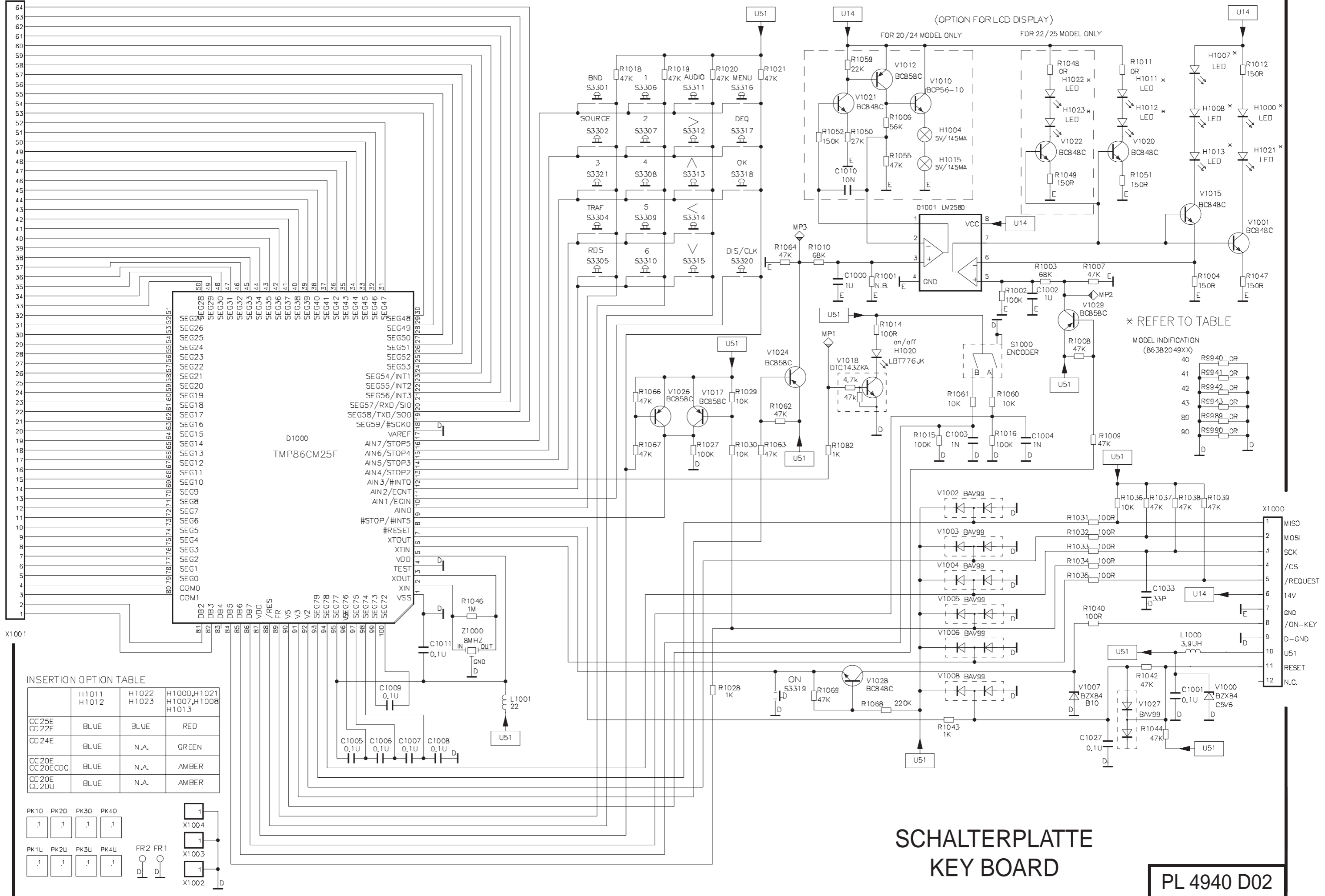

INSERTION OPTION TABLE

	H1011 H1012	H1022 H1023	H1000,H1021 H1007,H1008 H1013
CG25E CD22E	BLUE	BLUE	RED
CD24E	BLUE	N.A.	GREEN
CG20E CG20EGCG	BLUE	N.A.	AMBER
CD20E CD20U	BLUE	N.A.	AMBER

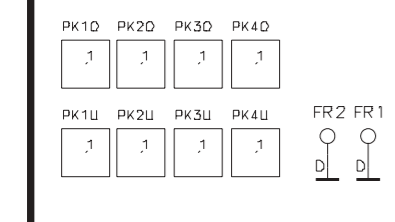

**SCHALTERPLATTE
KEY BOARD**

PL 4940 D02

× REFER TO TABLE
MODEL INDIFICATION
(86.38.20.49X X)

40	R9940_OR
41	R9941_OR
42	R9942_OR
43	R9943_OR
89	R9989_OR
90	R9990_OR

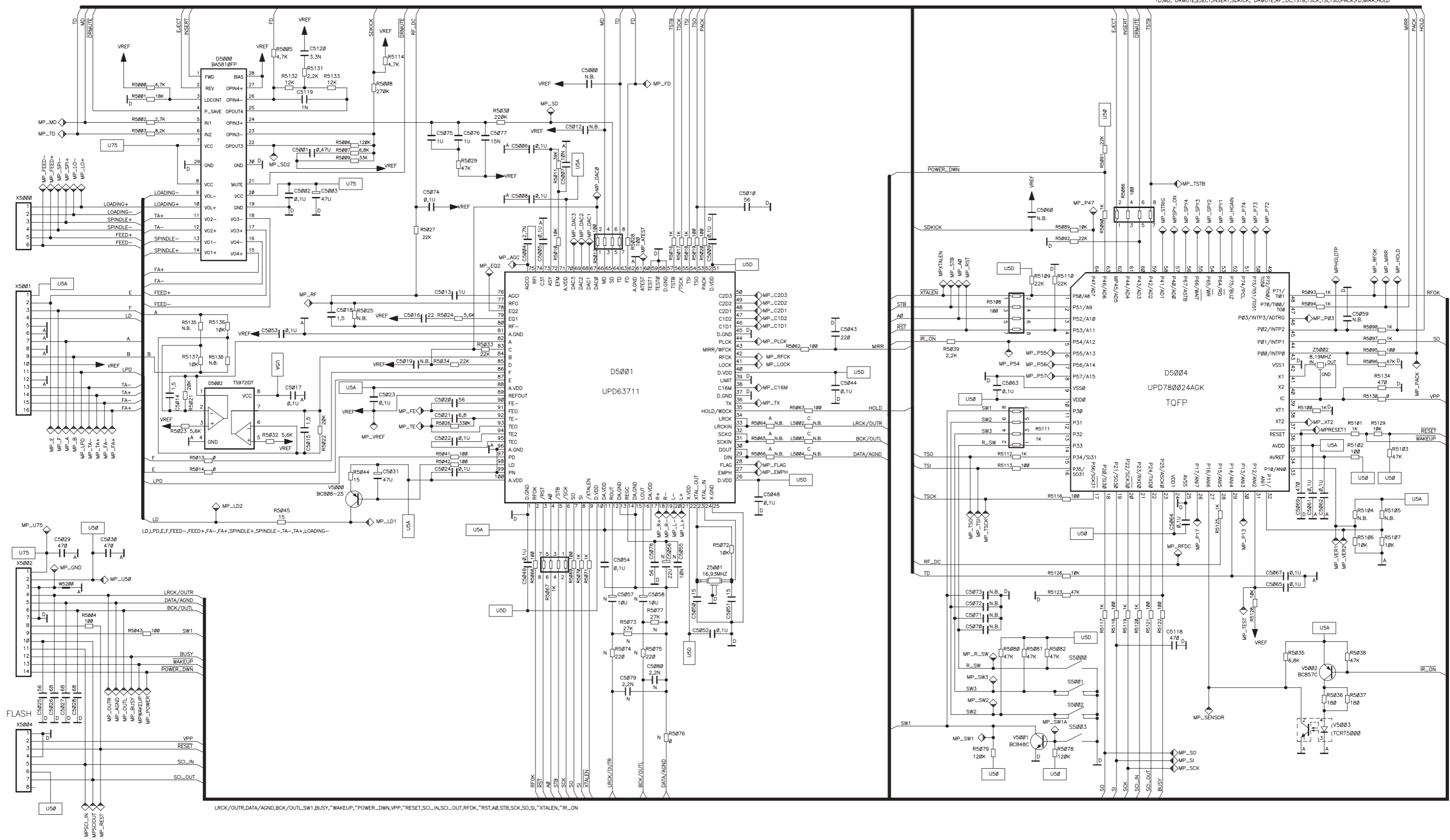

LRCK-/OUTR,DATA/AGND,BCK-/OUTL,SW1,BUSY,"WAKEUP","POWER_DWN,VPP,"RESET,SCL_IN,SCL_OUT,RFCK,"RST,A0,STB,SKC,SO,SI,"XTALEN,"IR_ON

**CD LAUFWERK BP4 R3 ANALOG
CD MECHANISM BP4 R3 ANALOG
Steuerplatte
Control board**

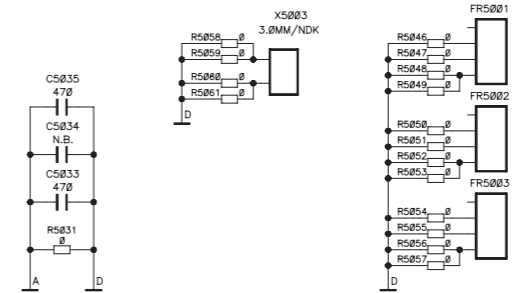
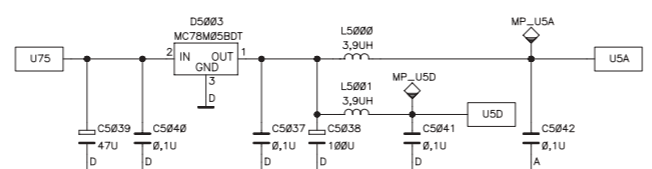

Variantenbestueckung fuer BP4R3S mit Digitalausgang

N = nicht bestueckt C = EMI 1K/100MHz
A = 220 Ohm

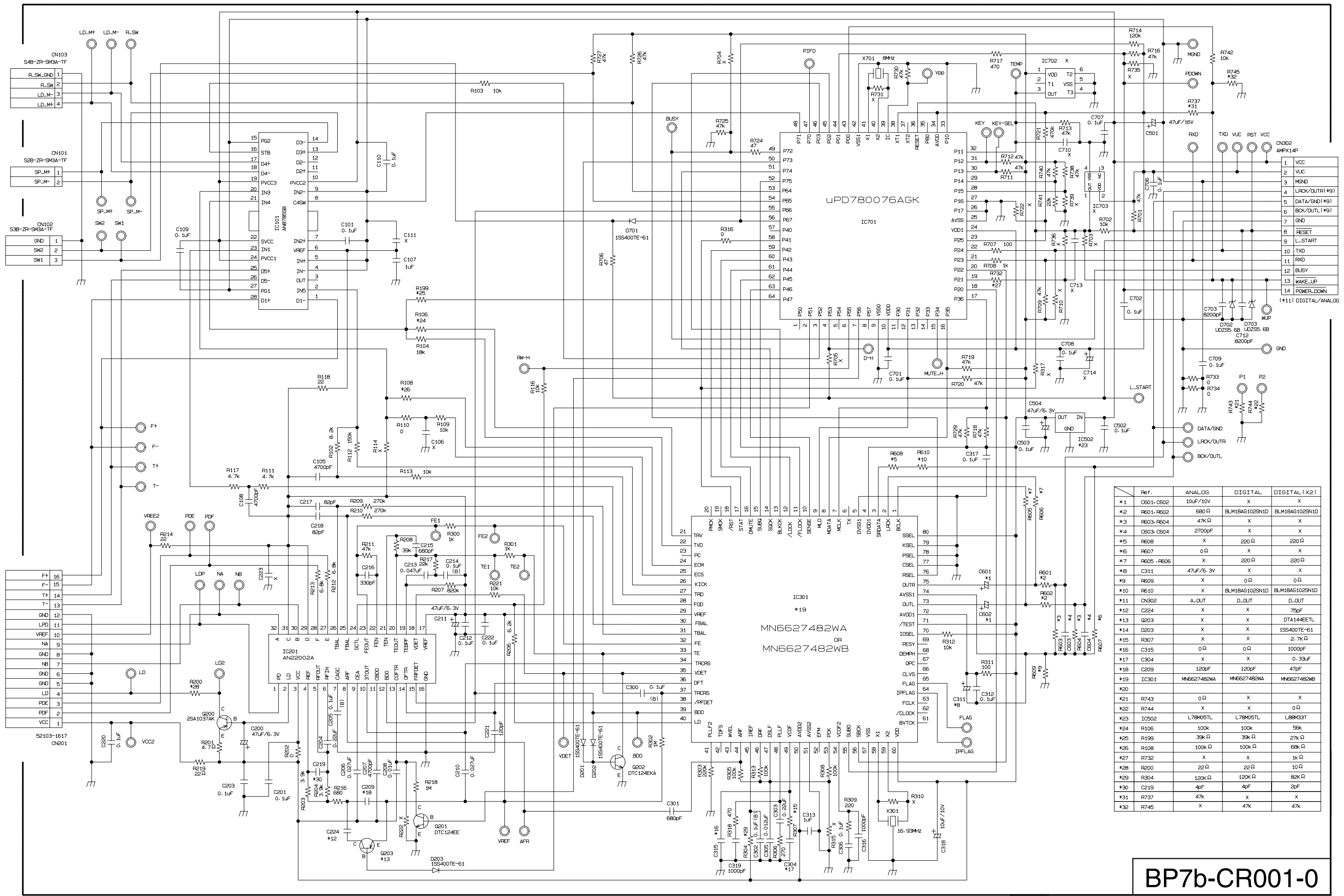

Ref.	ANALOG	DIGITAL	DIGITAL (X2)
*1	C501, C502	10uF/10V	X
*2	R601, R602	680 Ω	BLM18AG102SN1D
*3	R603, R604	47k Ω	X
*4	C503, C504	2700pF	X
*5	R608	X	220 Ω
*6	R607	0 Ω	X
*7	R605, R606	X	220 Ω
*8	C311	47uF/6.3V	X
*9	R609	X	0 Ω
*10	R610	X	BLM18AG102SN1D
*11	CN302	A.OUT	D.OUT
*12	C224	X	X
*13	Q203	X	DTA144EETL
*14	D203	X	X
*15	R307	X	X
*16	C315	0 Ω	1000pF
*17	C304	X	X
*18	C209	120pF	120pF
*19	IC301	MN6627482WA	MN6627482WB
*20			
*21	R743	0 Ω	X
*22	R744	X	X
*23	IC502	L78M05TL	L78M05TL
*24	R106	100k	100k
*25	R199	39k Ω	27k Ω
*26	R108	100k Ω	68k Ω
*27	R732	X	X
*28	R200	22 Ω	10 Ω
*29	R304	120k Ω	82k Ω
*30	C219	4pF	2pF
*31	R737	47k	X
*32	R745	X	47k

BP7b-CR001-0

TN708.3

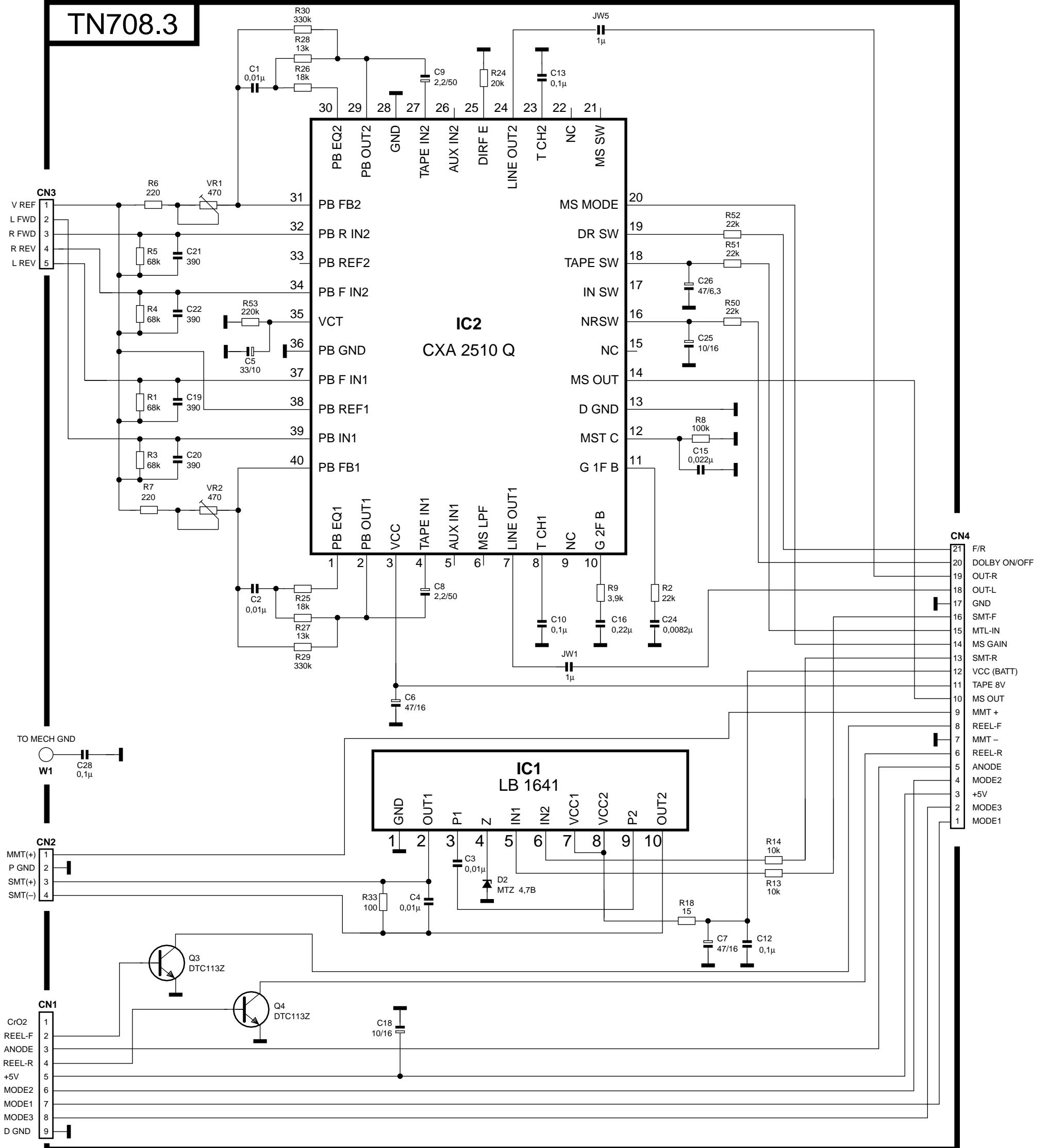

HAUPTPLATTE
MAINBOARD

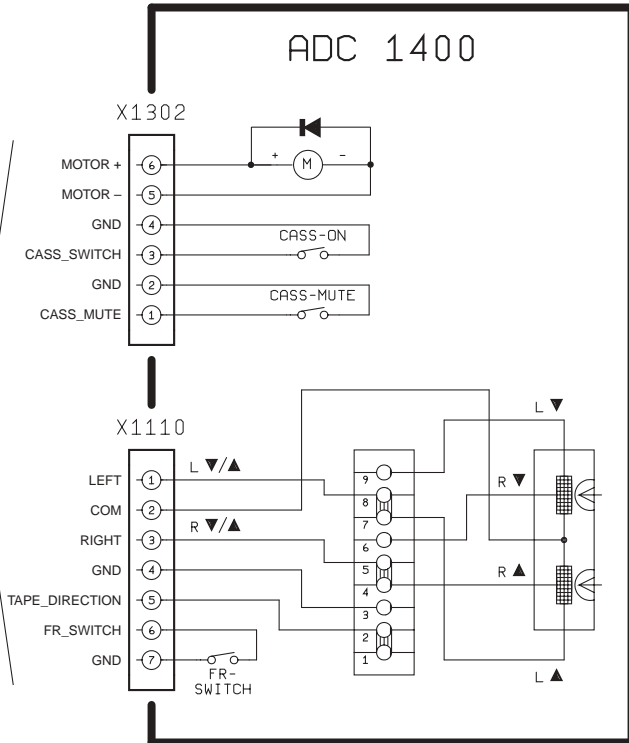

ANSCHLUSSPLATTE CONNECTOR BOARD

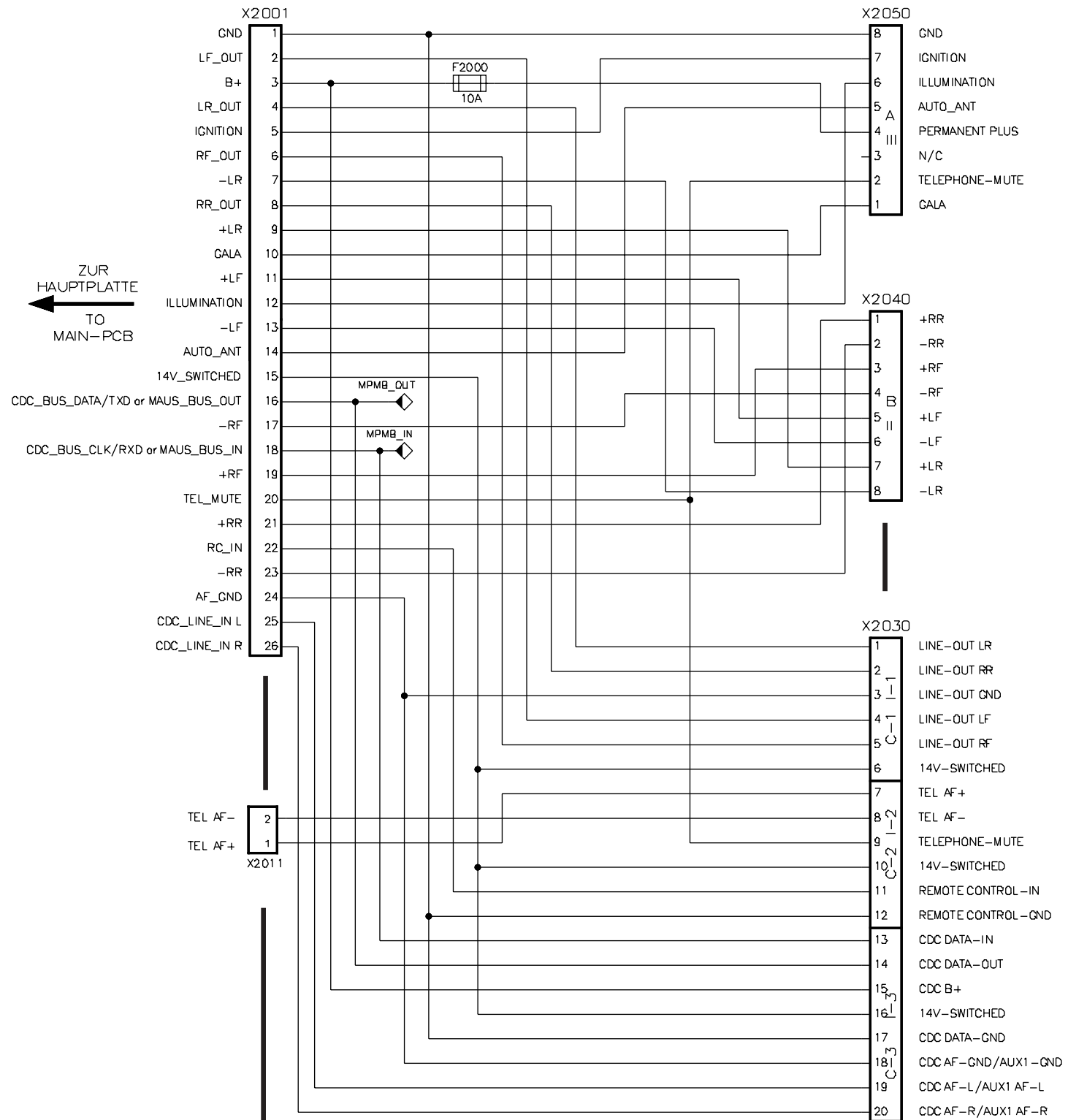

Anschiußplatte
Connector board
PL 8 638 214 596 D02

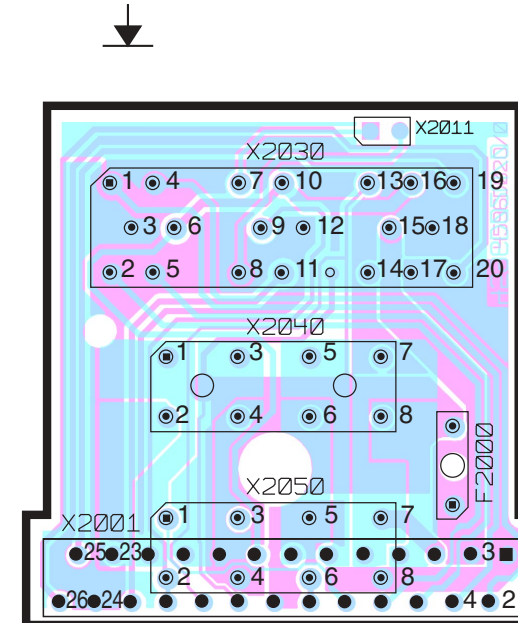

ANSCHLUSSPLATTE CONNECTOR BOARD

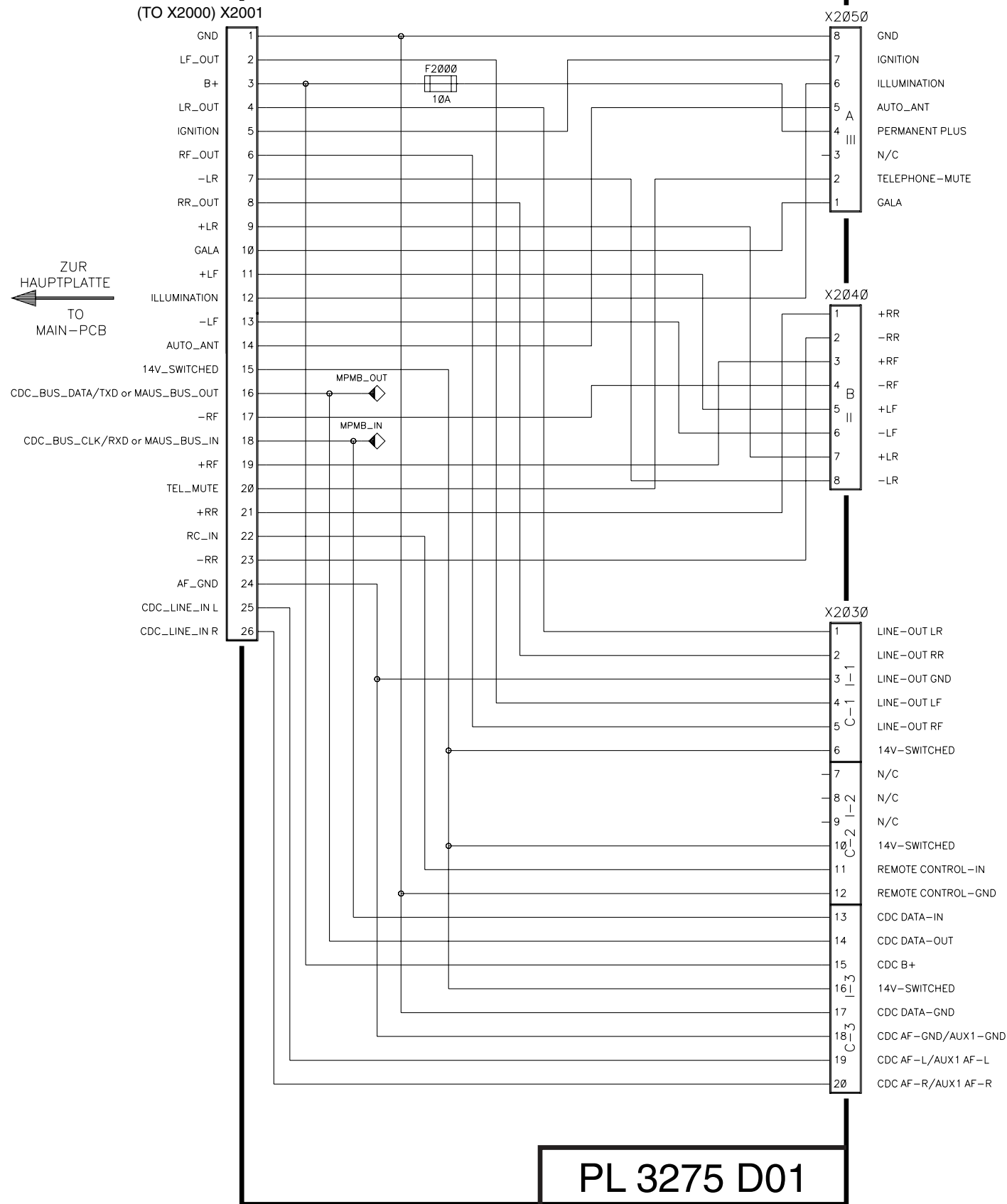

Anschiußplatte
Connector board
PL 8 638 213 275 D01

