

IVECO TRC 2446 RDS (24V)

7 607 005 024

K7/VKD 8 622 401 944 Sa 04/98

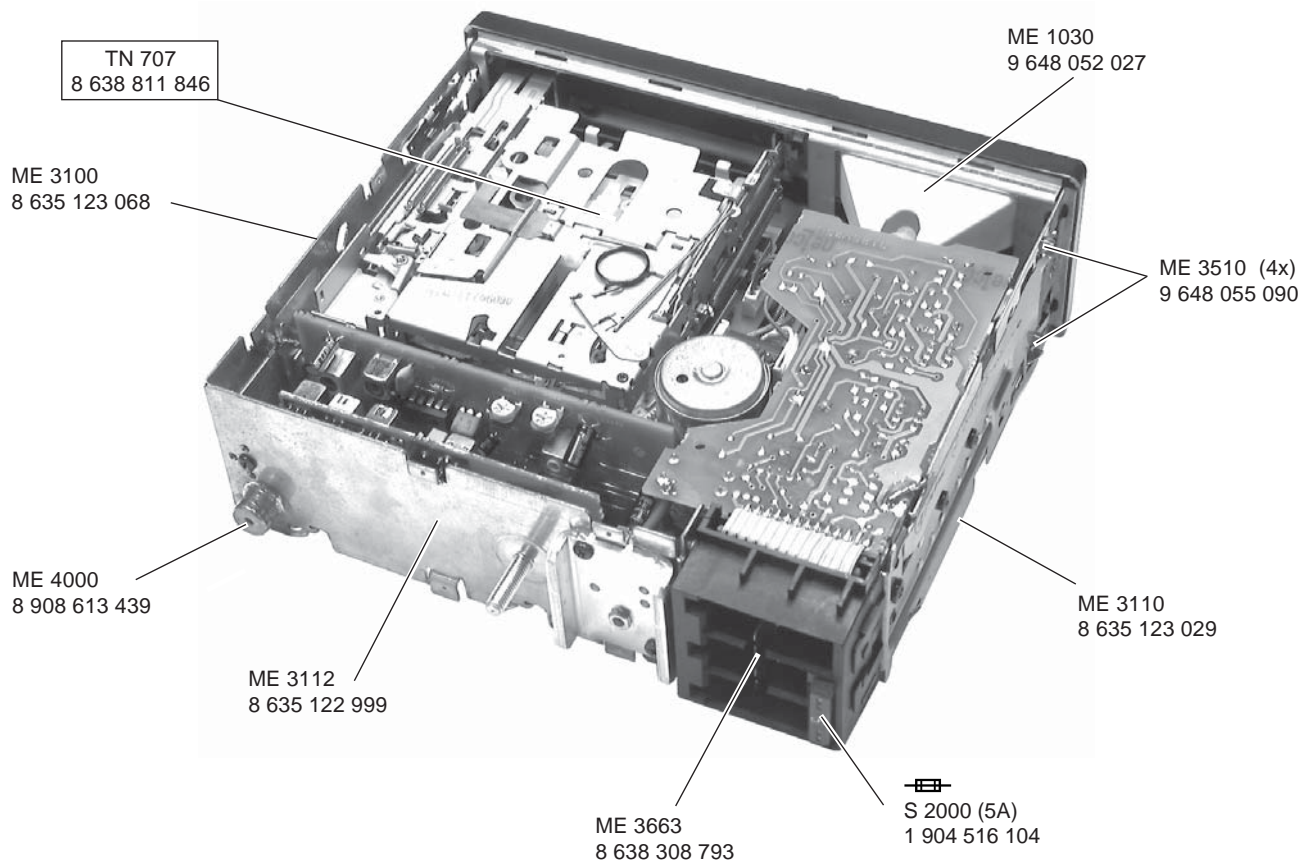







Ersatzteilliste • Spare Parts List • Liste de rechanges • Lista de repuestos

















Mechanische Bauteile Composants mécaniques			Mechanical parts Componentes mecánicos		
	(D)	(GB)	(F)	(E)	
ME 3101	DECKEL(OBEN/UNTEN)	HOUSING COVER	COUVERCLE DE BOIT.	TAPA DEL CARTER	8 635 132 602
ME 3103	GLIMMERSCHEIBE (D 2070)	MICA WASHER	PLAQUE DE MICA	ARANDELA DE MICA	8 630 161 587
ME 3215	DRUCKFEDER (EJ-KNOPF)	COMPRESSION SPRING	RESSORT PRESSION	MUELLE DE COMPRESI	8 634 630 192
ME 3414	DREHFEDER (CR-KLAPPE)	TORSION SPRING	RESSORT DE TORSION	MUELLE DE TORSION	9 648 055 144
ME 3481	KNOPFHALTER (FF/FR)	BUTTON HOLDER (FF/FR)	SUPP.DE BOUT. (FF/FR)	PORT A BOTÓN (FF/FR)	9 648 053 391
ME 3982	FÜHRUNGSBOLZEN	GUIDE PIN	TIGE DE GUIDAGE	PERNO DE GUIA	8 600 460 050
ME 3983	HALTERAHMEN	FRAME	CADRE SUPPORT	MARCO DE FIJACION	8 601 390 247
ME 3988	BUCHSENHALTER	JACK HOLDER	SUPPORT DE BORNE	SOPORTE DE BORNES	8 600 660 019
ME 3989	ANTENNENSTECKER	ANTENNA PLUG	FICHE D'ANTENNE	CLACIJA D'ANTENA	8 908 603 224
X 1000	BUCHSE F. DISPLAYFOLIE (34 polig)	SOCKET F.DISPLAY FOIL (34 pole)	PRISE P. FEUILLE D'AFFI. (34 pôles)	HEMBR. PARA HOJA DE D. (34 polos)	8 634 392 206

Mechanische Bauteile Composants mécaniques	TN 707 8 638 811 846	Mechanical parts Componentes mecánicos
---	---------------------------------------	---

Position Position Posición	Bestell-Nr. Part no. No. de commande Número de pedido	Position Position Posición	Bestell-Nr. Part no. No. de commande Número de pedido	Position Position Posición	Bestell-Nr. Part no. No. de commande Número de pedido
LW 1	8 628 800 438	LW 49	8 621 300 149	LW 98	8 620 105 441
LW 2	8 621 300 168	LW 50	8 621 901 741	LW 99	8 621 300 169
LW 3	8 626 600 475	LW 51	8 621 200 120	LW 100	8 621 901 733
LW 4	8 621 200 115	LW 52	8 624 600 673	LW 101	8 624 600 894
LW 5	8 628 800 221	LW 53	8 623 002 011	LW 102	8 626 300 445
LW 6	8 626 300 444	LW 54	8 621 901 728	LW 103	8 626 300 446
LW 7	8 621 300 160	LW 55	8 624 600 879	LW 104	8 628 800 432
LW 8	8 621 300 145	LW 56	8 626 600 477	LW 105	8 623 400 230
LW 9	8 627 609 515	LW 57	8 626 600 478		
LW 10	8 908 003 512	LW 58	8 621 901 720	LW 200	8 623 400 227
LW 11	8 621 901 691	LW 59	8 621 200 121	LW 201	8 623 400 211
LW 12	8 621 200 116	LW 60	8 621 200 122	LW 202	8 623 400 231
LW 13	8 620 105 426	LW 61	8 621 901 697	LW 203	8 620 105 429
LW 16	8 621 901 692	LW 62	8 621 901 729	LW 204	8 620 105 430
LW 17	8 621 901 693	LW 63	8 626 300 447	LW 205	8 623 400 216
LW 19	8 621 901 694	LW 64	8 621 300 151	LW 206	8 620 105 436
LW 20	8 621 901 686	LW 65	8 621 200 123	LW 207	8 620 105 427
LW 21	8 620 105 439	LW 66	8 621 200 124	LW 208	8 620 105 431
LW 22	8 620 105 440	LW 67	8 624 600 878	LW 209	8 620 105 432
LW 23	8 626 600 470	LW 68	8 627 205 766	LW 210	8 620 105 437
LW 24	8 626 600 471	LW 70	8 621 901 732	LW 211	8 623 400 215
LW 25	8 626 600 472	LW 71	8 626 600 461	LW 215	8 623 400 228
LW 26	8 626 600 473	LW 72	8 624 600 880	LW 216	8 623 400 212
LW 27	8 626 300 443	LW 74	8 620 100 549	LW 217	8 623 400 213
LW 28	8 621 901 721	LW 75	8 624 700 416	LW 218	8 623 400 214
LW 29	8 621 300 167	LW 77	8 624 600 800	LW 219	8 623 400 217
LW 30	8 621 200 117	LW 78	8 626 600 463	LW 220	8 620 105 453
LW 31	8 626 600 476	LW 79	8 626 600 464		
LW 32	8 621 901 764	LW 80	8 624 600 860	LW 301	8 621 901 736
LW 33	8 621 901 688	LW 81	8 621 901 704	LW 302	8 628 800 423
LW 34	8 621 200 118	LW 82	8 623 400 199	LW 303	8 622 002 103
LW 35	8 621 901 727	LW 83	8 621 901 730	LW 304	8 620 100 552
LW 36	8 627 205 752	LW 84	8 621 901 702	LW 305	8 621 901 735
LW 37	8 623 002 012	LW 85	8 624 600 881	LW 306	8 628 800 441
LW 38	8 628 309 769	LW 86	8 621 901 731		
LW 39	8 622 002 111	LW 87	8 623 400 210		
LW 40	8 908 003 514	LW 88	8 621 901 700		
LW 41	8 622 002 000	LW 89	8 621 200 128		
LW 42	8 905 405 342	LW 91	8 621 200 133		
LW 43	8 621 300 147	LW 92	8 621 901 698		
LW 44	8 621 901 580	LW 93	8 621 901 699		
LW 45	8 624 600 675	LW 94	8 621 300 152		
LW 46	8 622 306 053	LW 95	8 621 200 130		
LW 47	8 621 200 119	LW 96	8 621 300 153		
LW 48	8 621 300 148	LW 97	8 621 200 131		

Position Position Position Posición	Bezeichnung Designation Dénomination Denominación	Bestell-Nr. Part no. No. de commande Número de pedido
	SCHALTERPLATTE SWITCH BOARD PLAQUE D' INTERR. PLACA DE INTERR.	9 648 308 119
		
H 861- H 880 H 881	LYT 670 TLR 226	8 925 405 161 8 925 405 416
		
S 861- S 877		8 638 800 167
	NF - PLATTE, NF - BOARD, PLAQUETTE - NF, PLACA - NF	
		
C 2000	2200 µF	9 931 054 007
		
D 1650 D 1670	TDA 2052 TDA 2052	9 934 051 082 9 934 051 082
		
L 2000		8 948 411 066
		
V 1651 V 1671	1 N 4148 1 N 4148	8 925 405 822 8 925 405 822
	AM - PLATTE, AM BOARD, PLAQUETTE AM, PLACA AM	8 638 308 722
		
D 600	TDA 1572 T	8 925 900 175
		
L 602 L 603 L 604 L 605 L 606 L 612 L 613 L 650 L 651 L 652 L 660		8 948 415 058 8 948 415 057 8 908 411 056 8 948 415 062 8 948 415 063 8 948 412 066 8 948 412 067 8 948 415 055 8 948 415 060 8 948 415 064 8 948 413 011
		
Q 660	460 kHz	8 946 193 234

Position Position Position Posición	Bezeichnung Designation Dénomination Denominación	Bestell-Nr. Part no. No. de commande Número de pedido
		
V 600 V 601 V 602 V 603 V 604 V 605 V 606 V 607 V 608 V 609 V 610 V 611 V 612 V 613 V 619 V 620 V 621 V 622 V 623 V 630 V 635 V 645 V 649 V 650 V 651 V 652 V 690 V 691	ON 4288 BB 512 BC 858 C BFR 30 BFR 30 BB 512 BB 512 BAV 70 Z 47 BB 512 BC 848 C BC 848 C BC 848 C BAL 99 BAL 99 BFS 19 BC 858 C BC 858 C BAL 99 BAV 70 BAV 70 BC 848 B BC 848 C BB 512 BC 848 C BC 848 C BC 849 C BC 848 C	8 925 705 115 8 925 405 159 8 925 705 039 8 925 705 131 8 925 705 131 8 925 405 159 8 925 405 159 8 925 405 122 8 925 810 005 8 925 405 159 8 925 705 037 8 925 705 037 8 925 405 137 8 925 405 137 8 925 705 282 8 925 705 039 8 925 705 039 8 925 405 137 8 925 405 122 8 925 405 122 8 925 705 043 8 925 705 037 8 925 405 159 8 925 705 037 8 925 705 037 8 925 705 035 8 925 705 037
	FM - PLATTE, FM BOARD, PLAQUETTE FM, PLACA FM	9 648 308 073
		
D 3 D 4 D 5	TDA 1574 T3 RC 4558 DR TDA 1597 T	8 925 900 781 8 925 900 308 8 925 901 450
		
L 2 L 3 L 4 L 9 L 45 L 51 L 152 L 153		8 948 419 039 8 958 411 000 8 948 419 039 8 948 420 013 8 948 419 029 8 948 417 010 8 948 413 007 8 948 417 027
		
R 191	10 kΩ	9 930 050 105
		
V 1 V 2 V 4 V 10 V 20 V 40	BF 999 BC 858 C BA 885 BB 814 BB 814 BB 814	8 925 705 280 8 925 705 039 8 925 405 530 8 925 405 146 8 925 405 146 8 925 405 146

Position Position Position Posición	Bezeichnung Designation Dénomination Denominación	Bestell-Nr. Part no. No. de commande Número de pedido
V 161	BAV 70	8 925 405 122
V 162	1 N 4148	8 925 405 822
V 163	BAV 70	8 925 405 122
V 180	BC 848 B	8 925 705 043
V 181	BAV 99	8 925 405 124
V 2440	BFR 30	8 925 705 131
V 2454	BC 848 B	8 925 705 043
		
Z 150		8 946 193 313
Z 151		8 946 193 313
Z 155		8 946 193 313
HAUPTPLATTE, MAIN BOARD, PLAQUETTE PRINCIPALE, PLACA PRINCIPAL		
		
C 1111	22 µF	8 923 490 260
		
D 300	TDA 1592	8 925 901 456
D 700	SDA 4330 X-2	8 925 901 029
D 830	MC 68HC05B16	8 925 901 868
D 1000	TMP 47C847VF	8 925 901 647
D 1100	RC 4558 DR	8 925 900 308
D 1500	TEA 6320	8 925 901 095
D 2010	LM 317 T	8 945 901 736
D 2020	L 4949	8 925 900 348
D 2070	LM 317 T	8 945 901 736
D 2400	TMS 375C006	8 925 901 608
D 2500	TDA 7332 D	8 925 900 477
		
H 850		9 648 059 044
		
H 2700	14V, 80mA (klar)	8 928 410 031
		
L 50		9 935 050 151
L 700		9 935 050 106
L 701		8 928 411 045
L 1002		9 935 950 152
L 2000		8 948 411 066
L 2055		9 935 950 152
L 2400		9 935 950 152
		
V 50	SZ 7	8 925 405 877
V 51	SZ 7	8 925 405 877
V 306	BC 848 B	8 925 705 043
V 317	BC 848 B	8 925 705 043
V 502	BAS 21	8 905 407 070
V 700	BC 858 C	8 925 705 039
V 701	BC 848 C	8 925 705 037
V 702	BC 858 C	8 925 705 039
V 703	BC 858 C	8 925 705 039
V 720	BC 848 C	8 925 705 037
V 721	ZPD 10	8 905 421 291
V 831	BAV 99	8 925 405 124

Position Position Position Posición	Bezeichnung Designation Dénomination Denominación	Bestell-Nr. Part no. No. de commande Número de pedido
V 832	BAV 99	8 925 405 124
V 834	BAS 21	8 905 407 070
V 835	BAS 21	8 905 407 070
V 836	BAS 21	8 905 407 070
V 840	BC 848 B	8 925 705 043
V 841	BC 848 C	8 925 705 037
V 1000	BC 848 C	8 925 705 037
V 1010	BC 848 B	8 925 705 043
V 1300	1 N 4004 S	9 932 051 094
V 1350	BC 369	8 925 705 304
V 1355	BC 848 B	8 925 705 043
V 1421	BAL 99	8 925 405 137
V 1422	BC 858 C	8 925 705 039
V 2000	BD 442	8 945 706 044
V 2001	BYW 95 B	8 945 405 201
V 2002	BC 327-40	8 925 707 219
V 2003	BAV 21	8 905 406 008
V 2004	BC 846 B	8 925 705 271
V 2010	1 N 4148	8 925 405 822
V 2020	BC 848 C	8 925 705 037
V 2023	BZX 55/C5V1	8 905 421 272
V 2024	BZX 55/C5V1	8 905 421 272
V 2025	ZPY 47	8 905 421 382
V 2026	1 N 4148	8 925 405 822
V 2027	1 N 4148	8 925 405 822
V 2030	BC 548 C	9 933 051 106
V 2031	ZPD 10	8 905 421 291
V 2034	BC 548 C	9 933 051 106
V 2035	BC 848 B	8 925 705 038
V 2037	BC 848 B	8 925 705 038
V 2040	BC 337-25	8 925 707 347
V 2041	1 N 4148	8 925 405 822
V 2050	BAS 21	8 905 407 070
V 2051	BAS 21	8 905 407 070
V 2055	1 N 4002	8 905 405 636
V 2060	BC 848 C	8 925 705 037
V 2061	BC 848 C	8 925 705 037
V 2062	BC 858 C	8 925 705 039
V 2063	BC 848 C	8 925 705 037
V 2402	BC 848 B	8 925 705 043
V 2700	BC 848 C	8 925 705 037
V 2712	BC 846 B	8 925 705 271
		
Z 310	19 kHz	9 939 050 043
Z 830	4 MHz	8 926 193 002
Z 2400	4,332 MHz	8 946 193 203
 Hinweis: Handelsübliche Teile sind nicht in der Ersatzteilliste aufgeführt. Wir bitten Sie, diese Teile im Fachhandel zu beziehen. Note: Conventional components are not included in the spare part list. Please purchase them from a specialist dealer. Note: Les pièces vendues dans le commerce ne figurent pas sur la liste des pièces détachées. Nous vous prions de bien vouloir acheter ces pièces auprès des revendeurs. Observación: Piezas convencionales no están incluidas en la lista de recambios. Sírvase comprarlas de su comerciante especial.		

