

Serviceanleitung • Service Manual**Ⓓ Weitere Dokumentationen**

| | |
|------------------------------------|---------------|
| Schaltbild | 8 622 401 339 |
| Ersatzteilliste | 8 622 401 238 |
| Service Anleitung LW SCA 4.4 | 8 622 400 242 |

ⒺB Supplementary documentation:

| | |
|---|---------------|
| Circuit diagram | 8 622 401 339 |
| Spare part list | 8 622 401 238 |
| Service manual of mechanism SCA 4.4 | 8 622 400 242 |

Achtung:

Bei Arbeiten an den unter Spannung stehenden und nicht mit entsprechenden Filtern oder Streuscheiben abgedeckten LED's, müssen Sie folgende Sicherheitsvorschriften beachten:

1. Reparaturen oder Funktionsprüfungen dürfen nur mit einer Schutzbrille erfolgen.
Die zu verwendenden Sichtscheiben müssen einen UV- bzw. Sonnenschutzfilter haben (z.B. UVEX sportstyle 9186 088).
2. Der Betrieb mit höheren Strömen, auch kurzzeitig, ist nicht zulässig.
3. Der Blickwinkel zur Leiterplatte darf 60° nicht übersteigen.

Die Nichtbeachtung der Verarbeitungsvorschriften kann schwere Augenschädigungen zur Folge haben!

Attention:

For the process of handling the LEDs while they are supplied with their operating voltage and not covered by their respective filters or diffuser screens, the following instructions must be observed:

1. Repairs and function checks may be carried out with protection glasses only.
The used glass material must have a UV- or sun ray protection filter (e. g. UVEX sportstyle 9186 088).
2. The operation with higher currents, also for short duration, is not permitted.
3. The viewing angle towards the circuit board may not exceed 60°.

In the case of non-observance of the instructions serious damage to the eyes may result.

Inhaltsverzeichnis

| | |
|---|-------------|
| Sicherheitshinweise | 1 |
| Auslieferungszustände | 2 |
| Belegung des Anschlußkästchens | 2 |
| Voreinstellungen / Abgleichhinweise | 3 |
| Bedienungshinweise | 4 + 5 |
| Demontage | 6 - 8 |
| Antennenanpassung | 9 |
| Programmierung der Geräteparameter | 10,11,14,15 |
| Darstellung der Abgleichelemente | 12 |
| Darstellung der Meßpunkte | 13 |
| FM-Abgleich | 16 - 18 |
| AM-Abgleich (Audi Chorus) | 19 |
| AM-Abgleich (Audi Concert) | 20 + 21 |
| Dolby-Abgleich | 21 |

Table of Contents

| | |
|--|-------------|
| Safety instructions | 1 |
| Ex-factory condition | 2 |
| Pin assignment of quick-fit connector | 2 |
| Pre-adjustments / alignment instructions | 3 |
| Operating instructions | 4 + 5 |
| Dismantling | 6 - 8 |
| Antenna matching | 9 |
| Programming of product parameters | 10,11,14,15 |
| Representation of alignment elements | 12 |
| Representation of measuring points | 13 |
| FM alignment | 16 - 18 |
| AM alignment (Audi Chorus) | 19 |
| AM alignment (Audi Concert) | 20 + 21 |
| Dolby alignment | 21 |

D Auslieferungszustände

Audi Chorus

Das Autoradio kann mit 2 passiven Lautsprechern vorn und wahlweise mit 2 aktiven Lautsprechern hinten betrieben werden. Die Umschaltung erfolgt über Diagnosebus.

Auslieferungszustand: Defaultwerte (über Diagnosebus)
Fader aktiv,
LS hinten angeschlossen

Audi Concert

Das Autoradio kann mit zwei passiven Lautsprechern und zwei aktiven Lautsprechern oder als Bose-Soundanlage betrieben werden. Außerdem kann das Gerät in den US-Mode umgeschaltet werden. Die Umschaltung erfolgt über Diagnosebus.

Auslieferungszustand: Defaultwerte (über Diagnosebus)
Standard-Lautsprecher
Europa-Mode

GB Ex-factory condition

Audi Chorus

This car radio can be operated with 2 passive front loudspeakers and of choice with 2 active rear loudspeakers. The switching-over takes place by means of the diagnosis bus.

Ex-factory condition: Default values (via diagnosis bus)
Fader active
Rear loudspeakers connectable

Audi Concert

This car radio can be operated with 2 passive and 2 active loudspeakers or as a Bose sound system. In addition the unit can be switched to the US mode. The switching-over takes place by means of the diagnosis bus.

Ex-factory condition: Default values (via diagnosis bus)
Standard loudspeakers
Europe mode

Belegung des Anschlußkästchens

Pin assignment of quick-fit connector

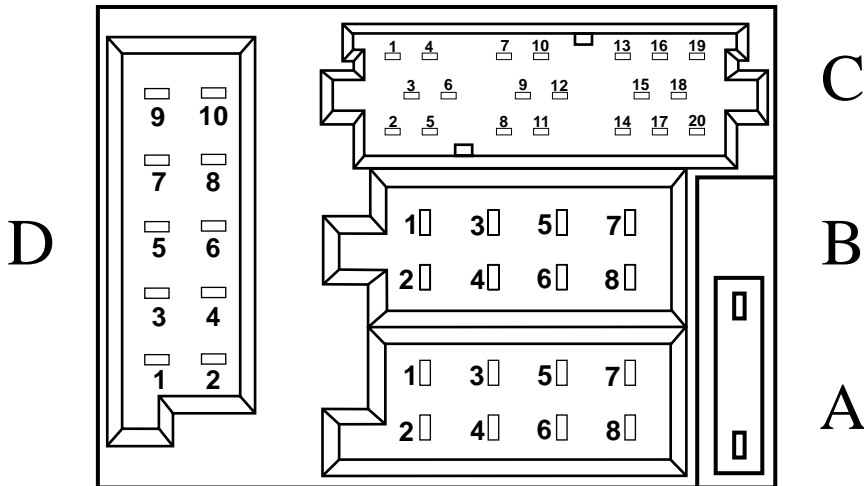

| A | | B | | D | |
|----|---------------------------------------|---|----------------------------------|----|------------------------------------|
| 1 | Gala input | 1 | n.c. | 1 | Telefon Mute / telephone mute |
| 2 | Externer Mute / External muting | 2 | n.c. | 2 | n.c. |
| 3 | K-Leitung (D.Bus) / K link (D.- bus) | 3 | NF vorne rechts / AF right front | 3 | NF/AF + |
| 4 | S-Kontakt / S-contact | 4 | NF Masse / AF ground | 4 | NF/AF - |
| 5 | Automatik Antenne / Automatic antenna | 5 | NF vorne links / AF left front | 5 | NF/AF+ |
| 6 | Beleuchtung 1 / Illumination 1 | 6 | NF Masse / AF ground | 6 | NF/AF - |
| 7 | Dauerplus / Permanent plus | 7 | n.c. | 7 | Steuerleitung Nav / Nav pilot line |
| 8 | Masse / Ground | 8 | n.c. | 8 | Telefon Mute / Telephone mute |
| 9 | | | | 9 | Beleuchtung 2 / Illumination 2 |
| 10 | | | | 10 | Masse CDC / CDC ground |

| C | | | | | |
|---|--|----|--|----|---|
| 1 | Line out LR | 7 | n.c | 13 | CDC Data in |
| 2 | Line out RR | 8 | Zweitdisplay Clock / 2nd display Clock | 14 | CDC Data out |
| 3 | Line out Masse / Line out ground | 9 | Zweitdisplay Data / 2nd display Data | 15 | CDC Clock |
| 4 | Line out LF | 10 | Zweitdisplay Ena / 2nd display Enable | 16 | CDC Dauerplus / CDC perman. plus |
| 5 | Line out RF | 11 | Fernbedienung / Remote control | 17 | CDC Steuerleitung / CDC pilot line |
| 6 | +12 V (Verstärker) / +12 V (amplifier) | 12 | n.c | 18 | CDC NF Masse / CDC AF ground |
| | | | | 19 | CDC NF in links / CDC AF Line-in, left |
| | | | | 20 | CDC NFin rechts / CDC AF Line-in, right |

mechan. Bauteile
Composants mécaniques

mechanical parts
Componentes mecánicas

| | (D) | (GB) | (F) | (E) | |
|---------|--------------------------|-----------------------------|-----------------------------------|-------------------------------------|---------------|
| ME 3140 | DECKEL (OBEN) | HOUSING COVER | COUVERCLE DE BOIT. | TAPA DEL CARTER | 8 635 131 600 |
| ME 3142 | DECKEL (UNTEN) | HOUSING COVER | COUVERCLE DE BOIT. | TAPA DEL CARTER | 8 635 131 601 |
| ME 3180 | RÜCKWAND (KAPPE) | REAR PANEL (CAP) | PANNEAU ARRIERE (CAPUCHON) | PANEL TRASERO (CASQUETE) | 8 630 060 175 |
| ME 3220 | DREHFEDER (CR-KLAPPE) | TORSION SPRING (CC-FLAP) | RESSORT DE TORSION (TRAPPE CC) | RESORTE DE TORSIÓN (TAPADERA CC) | 8 634 650 175 |
| ME 3470 | LICHTLEITER | LIGHT CONDUCTOR | PL. POUR LAMPES | CONEXION FIBRA OPTICA | 8 635 370 438 |
| X 1001 | STIFTLEISTE (14 POL.) | PIN CONNECTOR | BARRETTE A TIGES | REGLETA DE CLAVIJA | 8 638 801 193 |
| X 1301 | BUCHSENLEISTE (8 POL.) | FEMALE CONNECTOR | REGLETTE DE BORNES | REGLETA DE BORNES | 8 638 800 541 |
| X 1302 | STECKERGEÄUSE (5 POL.) | PLUG HOUSING | BOITIER DE FICHE | CAJA DE CLAVIJA | 8 908 603 421 |
| X 1000 | BUCHSENLEISTE (14 POL.) | FEMALE CONNECTOR | REGLETTE DE BORNES | REGLETA DE BORNES | 8 638 801 192 |

ME 3401
Audi chorus
8 636 590 303
Audi concert
8 636 590 309







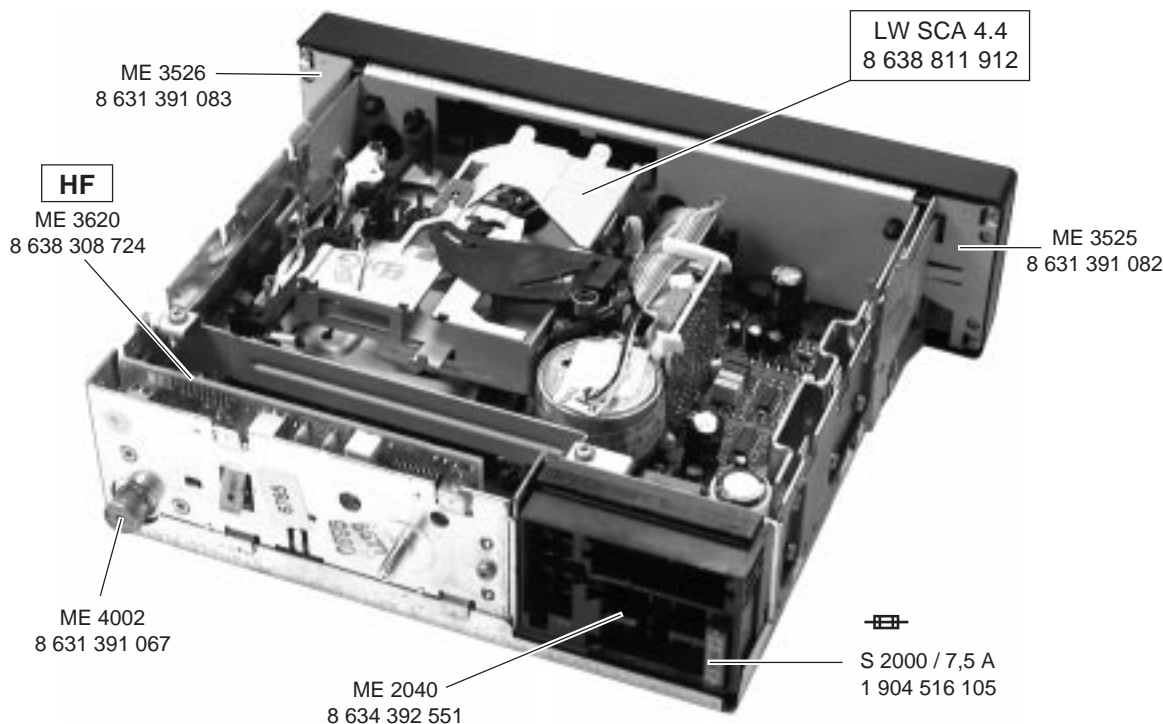
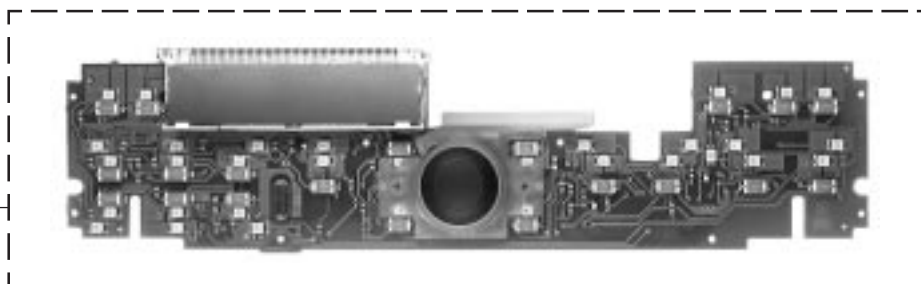

(Die abgebildete Einheit ist nur komplett zu wechseln, da die Kontaktierung der Folie nur im Fertigungsprozeß möglich ist.)
(The illustrated unit must be exchanged completely, as the contact assignment of the foil can only be done in the manufacturing process.)
(N'échanger l'unité illustrée que complètement, car le bonding de la feuille est seulement possible pendant le processus de fabrication.)
(Hay que recambiar la unidad ilustrada completamente, ya que la asignación de los contactos sólo es posible dentro del proceso de fabricación.)

LCD + Schalterplatte







LCD + Switch board,
LCD + Plaque d'interruption,
LCD + Placa de interrupt







ME 3650
Audi chorus
8 638 812 082
Audi concert
8 638 812 081



| Position Position Position Posición | Bezeichnung Designation Dénomination Denominación | Bestell-Nr. Part no. No. de commande Número de pedido |
|---|---|--|
| HAUPTPLATTE, MAIN BOARD, PLAQUETTE PRINCIPALE, PLACA PRINCIPAL | | |
| |  | |
| C 2000 | 3300 µF | 8 943 490 359 |
| |  | |
| D 310 | TDA 1592 | 8 925 901 456 |
| D 660 | TDA 1072 A | 8 925 900 247 |
| D 800 | MC 68HC05B32 | 8 925 904 134 |
| D 810 | M 74HC132 | 8 925 901 841 |
| D 820 | MC 14551 | 8 925 900 912 |
| D 830 | MC 68HC05C8 | 8 925 904 143 |
| D 1100 | HA 1299 F | 8 925 901 837 |
| D 1100 | HA 12194 F | 8 925 901 838 |
| D 1400 | TDA 7342 | 8 925 901 723 |
| D 1500 | MC 14551 | 8 925 900 912 |
| D 1501 | LM 837 | 8 925 900 205 |
| D 1502 | LM 837 | 8 925 900 205 |
| D 1573 | LM 837 | 8 925 900 205 |
| D 1600 | TDA 7376 B | 8 945 903 286 |
| D 2010 | BSP 452 | 8 925 705 301 |
| D 2011 | BSP 452 | 8 925 705 301 |
| D 2012 | BSP 452 | 8 925 705 301 |
| D 2051 | MC 78M05 | 8 945 902 581 |
| D 2050 | MC 78L05 | 8 925 901 517 |
| D 2060 | L 4949 | 8 925 901 447 |
| D 2061 | L 4952 | 8 925 901 732 |
| D 2200 | MSM 6688 | 8 925 901 429 |
| D 2201 | MSM 6684 | 8 925 901 527 |
| D 2400 | TMS 375C006 | 8 925 901 774 |
| D 2450 | TDA 7332 | 8 925 900 477 |
| D 8210 | LM 258D | 8 925 900 905 |
| D 8250 | RC 4558 | 8 925 900 308 |
| |  | |
| H 1020 | LHT 774 | 8 925 405 212 |
| |  | |
| L 600 | | 8 948 411 059 |
| L 602 | | 8 948 415 077 |
| L 603 | | 8 948 415 056 |
| L 604 | | 8 948 411 059 |
| L 650 | | 8 948 415 055 |
| L 660 | | 8 948 413 008 |
| L 800 | | 8 948 411 060 |
| L 830 | | 8 948 411 060 |
| L 2000 | | 8 948 411 090 |
| L 2000 | | 8 948 411 065 |
| L 2030 | | 8 948 411 089 |
| L 2400 | | 8 948 411 060 |
| L 2450 | | 8 948 411 060 |
| |  | |
| R 1210/ R 1220 | 4,7 kΩ | 8 921 500 004 |
| |  | |
| V 311 | DTC 143 ZK | 8 925 705 234 |
| V 315 | BAL 99 | 8 925 405 137 |
| V 340 | BC 848 B | 8 925 705 043 |
| V 341 | BAL 99 | 8 925 405 137 |
| V 342 | BC 848 B | 8 925 705 043 |
| V 600 | Z 47 | 8 925 421 048 |

| Position Position Position Posición | Bezeichnung Designation Dénomination Denominación | Bestell-Nr. Part no. No. de commande Número de pedido |
|--|--|--|
| V 601 | BB 512 | 8 925 405 159 |
| V 602 | BB 512 | 8 925 405 159 |
| V 603 | BAL 99 | 8 925 405 137 |
| V 604 | BAL 99 | 8 925 405 137 |
| V 605 | ON 4228 | 8 925 705 115 |
| V 606 | BC 858 C | 8 925 705 141 |
| V 607 | BC 858 C | 8 925 705 141 |
| V 608 | BFS 19 | 8 925 705 282 |
| V 609 | BFR 30 | 8 925 705 131 |
| V 650 | BB 512 | 8 925 405 159 |
| V 690 | BC 848 B | 8 925 705 043 |
| V 811 | BC 848 B | 8 925 705 043 |
| V 812 | BC 848 B | 8 925 705 043 |
| V 820 | BC 848 B | 8 925 705 043 |
| V 821 | BC 848 B | 8 925 705 043 |
| V 823 | BAV 99 | 8 925 405 124 |
| V 824 | BC 848 B | 8 925 705 043 |
| V 825 | BAL 99 | 8 925 405 137 |
| V 840 | BC 848 B | 8 925 705 043 |
| V 841 | BAW 56 | 8 925 405 015 |
| V 870 | BC 858 B | 8 925 705 038 |
| V 871 | BC 858 B | 8 925 705 038 |
| V 872 | BAV 70 | 8 925 405 122 |
| V 1050 | BC 848 B | 8 925 705 043 |
| V 1055 | BC 848 C | 8 925 705 139 |
| V 1100 | BC 848 B | 8 925 705 043 |
| V 1500 | BC 848 C | 8 925 705 139 |
| V 1501 | BC 848 C | 8 925 705 139 |
| V 1502 | BC 848 C | 8 925 705 139 |
| V 1503 | BC 858 C | 8 925 705 039 |
| V 1504 | BC 858 C | 8 925 705 039 |
| V 1550 | BAL 99 | 8 925 405 137 |
| V 2000 | S 3 G | 8 925 405 023 |
| V 2011 | BAS 21 | 8 925 405 182 |
| V 2012 | BC 858 C | 8 925 705 039 |
| V 2013 | BAS 21 | 8 925 405 182 |
| V 2012 | BC 858 C | 8 925 705 039 |
| V 2030 | FMMT 493 | 8 925 705 192 |
| V 2031 | BC 858 B | 8 925 705 038 |
| V 2032 | BC 858 B | 8 925 705 038 |
| V 2033 | BC 848 C | 8 925 705 139 |
| V 2034 | BC 848 C | 8 925 705 139 |
| V 2035 | BC 848 B | 8 925 705 043 |
| V 2036 | BC 848 C | 8 925 705 139 |
| V 2061 | RLR 4001 | 8 925 800 044 |
| V 2062 | BC 848 C | 8 925 705 139 |
| V 2063 | BC 848 C | 8 925 705 139 |
| V 2064 | BAL 99 | 8 925 405 137 |
| V 2080 | BCX 53-16 | 8 925 705 137 |
| V 2081 | BC 858 C | 8 925 705 039 |
| V 2082 | BC 848 B | 8 925 705 043 |
| V 2085 | BAL 99 | 8 925 405 137 |
| V 2200 | BC 858 C | 8 925 705 039 |
| V 2201 | BC 848 C | 8 925 705 139 |
| V 2202 | DTC 144EKT | 8 925 705 264 |
| V 2203 | DTC 144EKT | 8 925 705 264 |
| V 2300 | BC 858 B | 8 925 705 038 |
| V 2470 | BC 858 C | 8 925 705 039 |
| V 2471 | BC 858 C | 8 925 705 039 |
| V 2472 | BC 858 C | 8 925 705 039 |
| V 2473 | BC 848 C | 8 925 705 139 |
| V 2474 | BC 848 C | 8 925 705 139 |
| V 2475 | BAW 56 | 8 925 405 015 |
| V 2800 | BC 858 B | 8 925 705 038 |
| V 2801 | BAV 99 | 8 925 405 124 |
| V 5301 | BC 848 B | 8 925 705 043 |
| V 5302 | BZX 84/C5V6 | 8 905 421 459 |
| V 5303 | BZX 84/C5V6 | 8 905 421 459 |
| V 5304 | BZX 84/C5V6 | 8 905 421 459 |

| Position Position Position Posición | Bezeichnung Designation Dénomination Denominación | Bestell-Nr. Part no. No. de commande Número de pedido |
|---|--|--|
| V 8200 | BC 808-25 | 8 925 705 042 |
| V 8202 | BC 808-25 | 8 925 705 042 |
| V 8210 | BZX 84/C4V7 | 8 925 421 061 |
| V 8219 | BAL 99 | 8 925 405 137 |
| V 8220 | BC 846 B | 8 925 705 229 |
| V 8221 | BZX 84/C18 | 8 925 421 059 |
| V 8222 | BC 858 C | 8 925 705 039 |
| V 8223 | BC 848 C | 8 925 705 139 |
| V 8224 | BC 858 C | 8 925 705 039 |
| V 8225 | BC 818-40 | 8 925 705 228 |
| V 8226 | BZX 84/C12 | 8 925 421 044 |
| V 8227 | BZX 84/C12 | 8 925 421 044 |
| V 8228 | BAV 70 | 8 925 405 122 |
| V 8230 | BZX 84/C4V7 | 8 925 421 061 |
| V 8250 | BZX 84/C4V7 | 8 925 421 061 |
| V 8251 | BC 848 B | 8 925 705 043 |
|  | | |
| Z 310 | | 8 946 193 307 |
| Z 800 | | 8 926 193 002 |
| Z 660 | | 8 946 193 039 |
| Z 850 | | 8 946 193 039 |
| Z 2200 | | 8 926 193 018 |
| Z 2410 | | 8 926 193 001 |
| HF - PLATTE, HF BOARD, PLAQUETTE HF, PLACA HF | | 8 638 308 724 |
|  | | |
| D 3 | TDA 1575 T | 8 925 900 339 |
| D 152 | TDA 1597 T | 8 925 901 450 |
| D 180 | TL 072 IDR | 8 925 900 201 |
| D 700 | SDA 4331 | 8 925 901 532 |
|  | | |
| L 1 | | 8 958 411 133 |
| L 2 | | 8 948 419 063 |
| L 3 | | 8 958 411 000 |
| L 4 | | 8 948 419 063 |
| L 6 | | 8 948 419 043 |
| L 9 | | 8 928 411 059 |
| L 50 | | 8 928 411 059 |
| L 601 | | 8 958 411 133 |
| L 700 | | 8 928 411 060 |
| L 701 | | 8 928 411 058 |
|  | | |
| R 166 | 100 kΩ | 8 921 500 006 |
|  | | |
| V 1 | BF 999 | 8 925 705 280 |
| V 2 | BC 858 C | 8 925 705 039 |
| V 4 | BB 814 | 8 925 405 146 |
| V 8 | BB 814 | 8 925 405 146 |
| V 15 | BB 814 | 8 925 405 146 |
| V 21 | BA 885 | 8 925 405 530 |
| V 50 | S 247 Z | 8 925 421 079 |
| V 159 | 1 N 4148 | 8 925 405 233 |
| V 181 | BAV 99 | 8 925 405 124 |
| V 183 | BC 848 C | 8 925 705 037 |
| V 741 | BC 848 C | 8 925 705 037 |
|  | | |
| Z 1 | | 8 948 417 028 |

| Position Position Position Posición | Bezeichnung Designation Dénomination Denominación | Bestell-Nr. Part no. No. de commande Número de pedido |
|---|--|--|
| Z 150 | | 8 926 193 201 |
| Z 151 | | 8 926 193 201 |
| Z 152 | | 8 948 417 027 |
| Z 155 | | 8 926 193 201 |
| Z 700 | | 8 926 193 002 |
| SCHALTERPLATTE SWITCH BOARD PLAQUE D' INTERR. PLACA DE INTERR. | | |
|  | | |
| D 1000 | ST 6280BQ6 | 8 925 901 775 |
| D 1001 | LM 258 D | 8 925 900 905 |
| D 1070 | MC 14094 | 8 925 900 913 |
|  | | |
| H 1001- | | |
| H 1085 | LST 676 P/Q | 8 925 405 446 |
|  | | |
| L 1000 | | 8 948 420 016 |
|  | | |
| S 850- | | |
| S 885 | | 8 638 800 630 |
|  | | |
| S 890 | | 8 941 481 057 |
|  | | |
| V 1021 | SFH 320-3 | 8 925 705 189 |
| V 1022 | BC 858 B | 8 925 705 038 |
| V 1028 | DTC 143 ZK | 8 925 705 234 |
| V 1029 | BC 818-25 | 8 925 705 041 |
| V 1046 | DTC 143 ZK | 8 925 705 234 |
| V 1048 | BC 818-25 | 8 925 705 041 |
| V 1086- | | |
| V 1091 | DTC 143 ZK | 8 925 705 234 |
| V 1092 | DTA 143 ZKA | 8 925 705 233 |
| V 1093 | DTC 143 ZK | 8 925 705 234 |
| V 1094 | DTA 143 ZKA | 8 925 705 233 |
| V 1095 | BC 808-25 | 8 925 705 042 |
| V 1096 | DTC 143 ZK | 8 925 705 234 |
|  | | |
| Z 1009 | | 8 926 193 012 |
| Hinweis: Handelsübliche Kondensatoren und Widerstände sind in der Ersatzteilliste nicht aufgeführt. Wir bitten Sie, diese Teile im Fachhandel zu beziehen. | | |
| Note: Capacitors and resistors usual in trade are not mentioned in the spare parts list. Kindly buy these parts from the specialized trade. | | |
| Nota: Des condensateurs et résistances commerciaux ne sont pas inclus dans la liste des pièces détachées. Veuillez acheter ces pièces chez votre spécialiste. | | |
| Nota: No se indican en la lista de piezas de repuestos los condensadores y los resistores de uso comercial. Les rogamos comprar esas piezas en el comercio especializado. | | |

Explosionszeichnung / Exploded View / Vue éclatée / Dibujo de tipo explosión

8 638 811 912

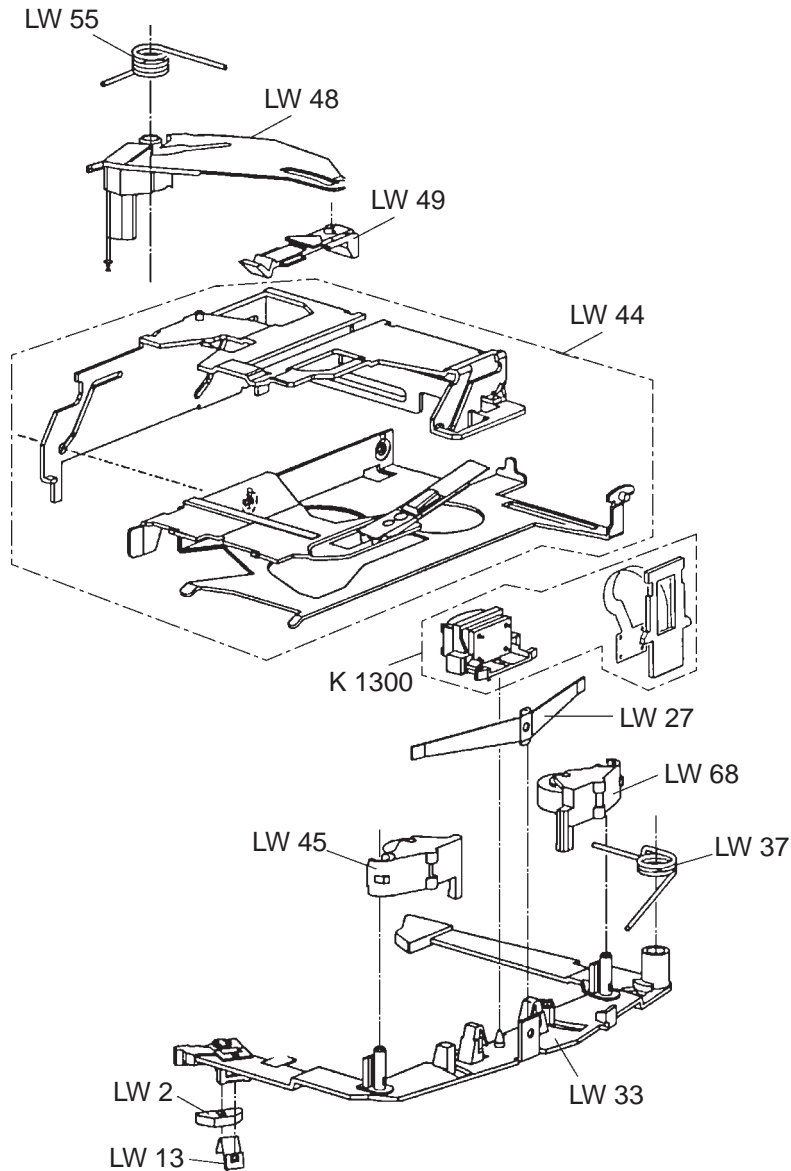

| Position | Bestell-Nr. |
|----------|------------------|
| Position | Part no. |
| Position | No. de commande |
| Posición | Número de pedido |
| LW 2 | 8 624 200 609 |
| LW 13 | 8 621 300 163 |
| LW 27 | 8 621 200 134 |
| LW 33 | 8 621 300 564 |
| K 1300 | 8 628 800 435 |
| LW 37 | 8 624 600 885 |
| LW 44 | 8 621 300 563 |
| LW 45 | 8 626 600 493 |
| LW 48 | 8 621 404 748 |
| LW 49 | 8 621 901 749 |
| LW 55 | 8 624 600 886 |
| LW 68 | 8 626 600 494 |

Blaupunkt-Werke GmbH, Hildesheim

Änderungen vorbehalten! Nachdruck - auch auszugsweise - nur mit Quellenangabe gestattet

Gedruckt in Deutschland
Printed in Germany by HDR

Modification réservées! Reproduction - aussi en abrégé - permise seulement avec indication des sources utilisées

Modification reserved! Reproduction - also by extract - only permitted with indication of sources used

¡Modificaciones reservadas! Reproducción - también en parte - solamente permitida con indicación de las fuentes utilizadas

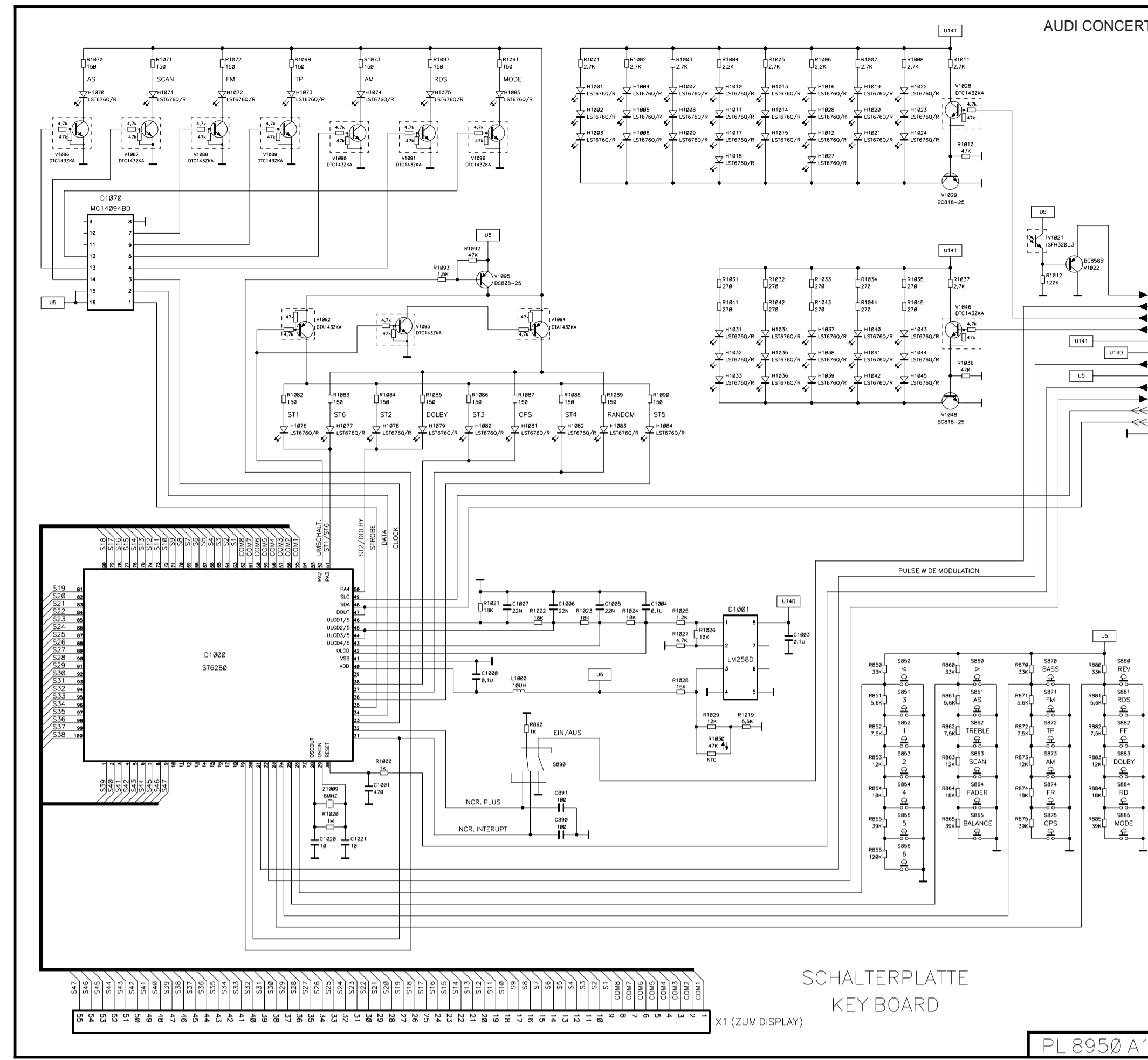
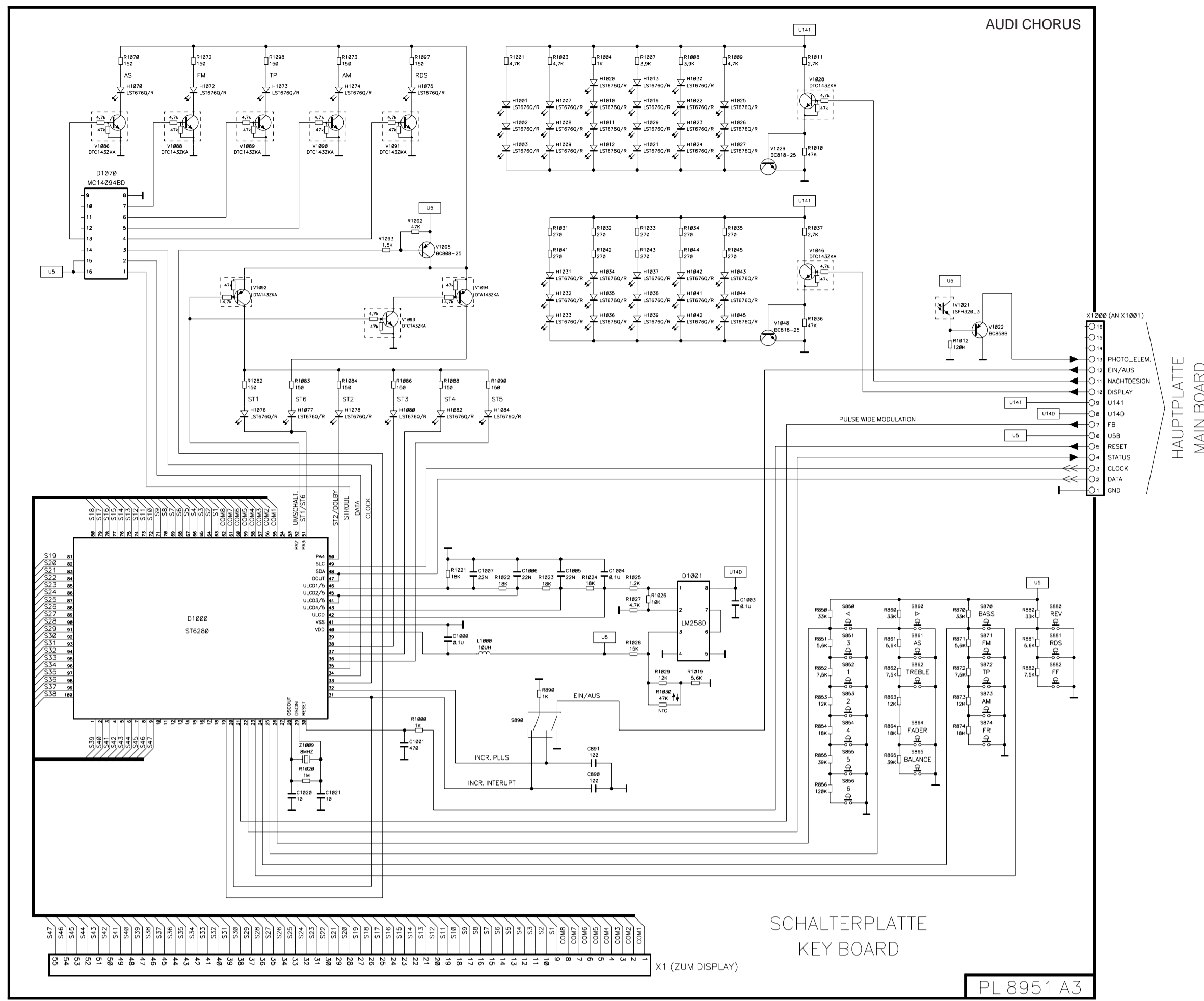

Schalterplatte
Key board
PL 8950 A01
B + Chip

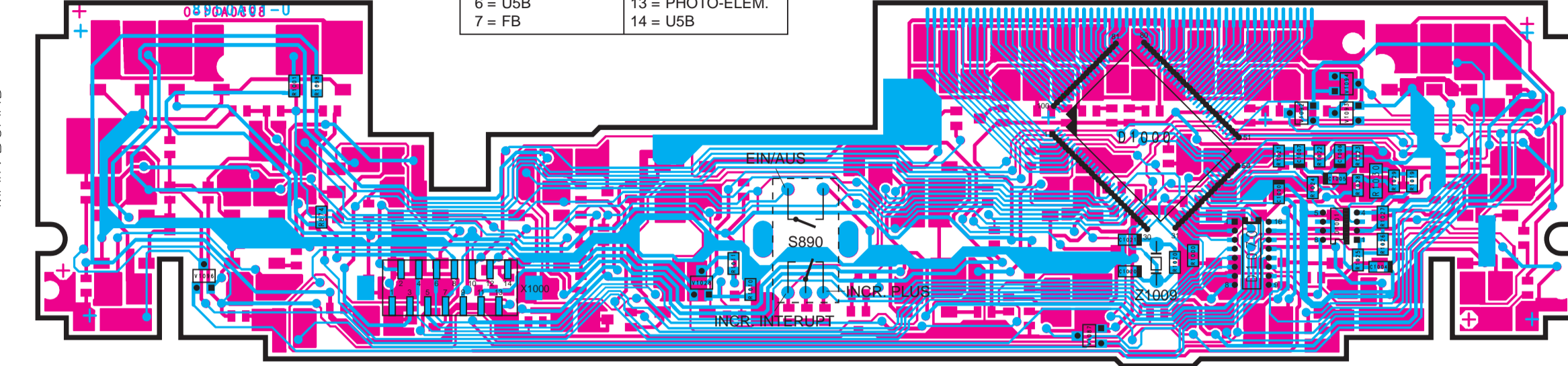

Schalterplatte
Key board
PL 8950 A01
Chip

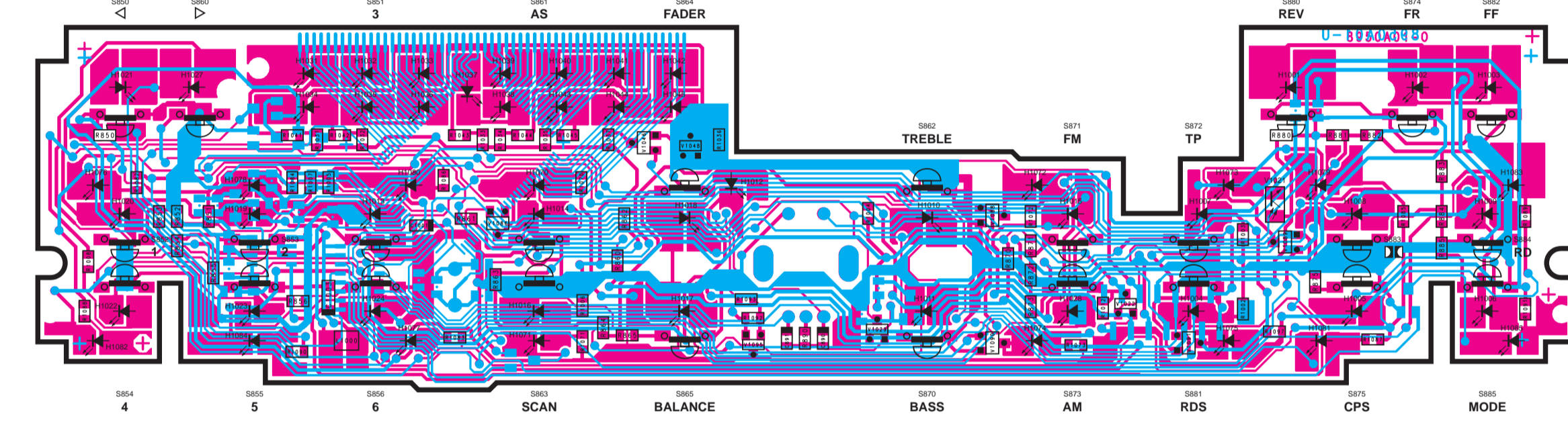

HF-Platte
RF board
PL 8724 A05
Chip

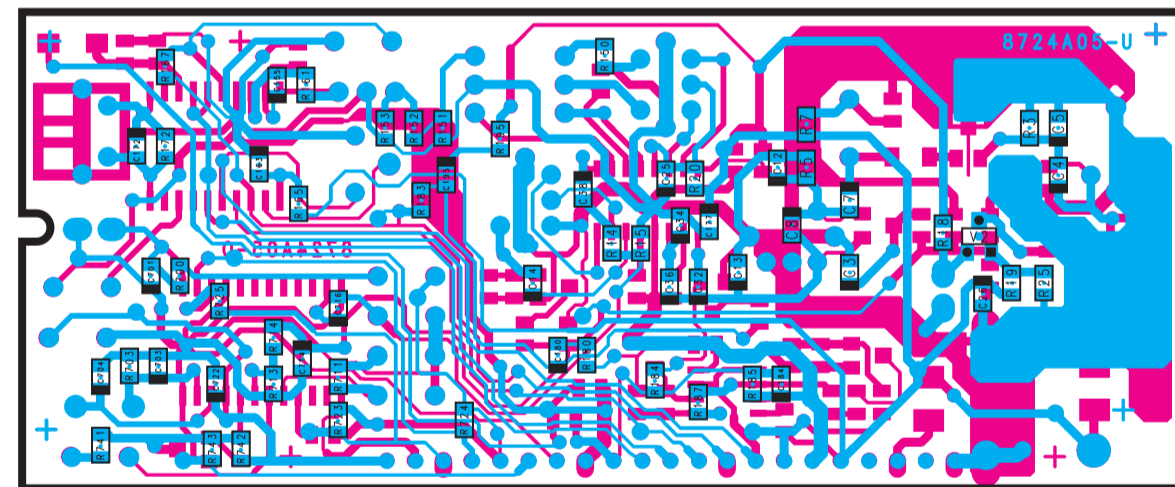

HF-Platte
RF board
PL 8724 A05
Chip

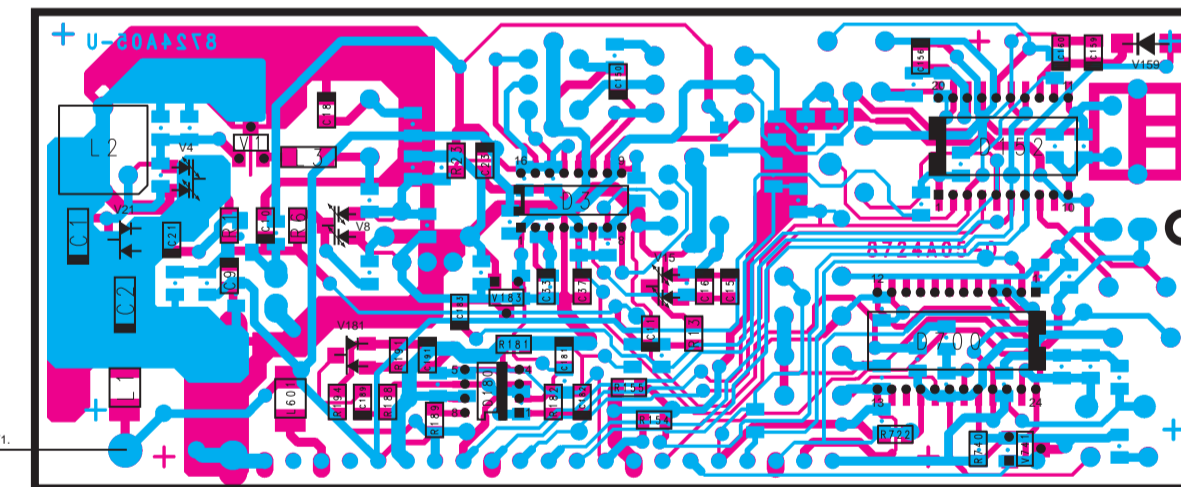

HF-Platte
RF board
PL 8724 A05

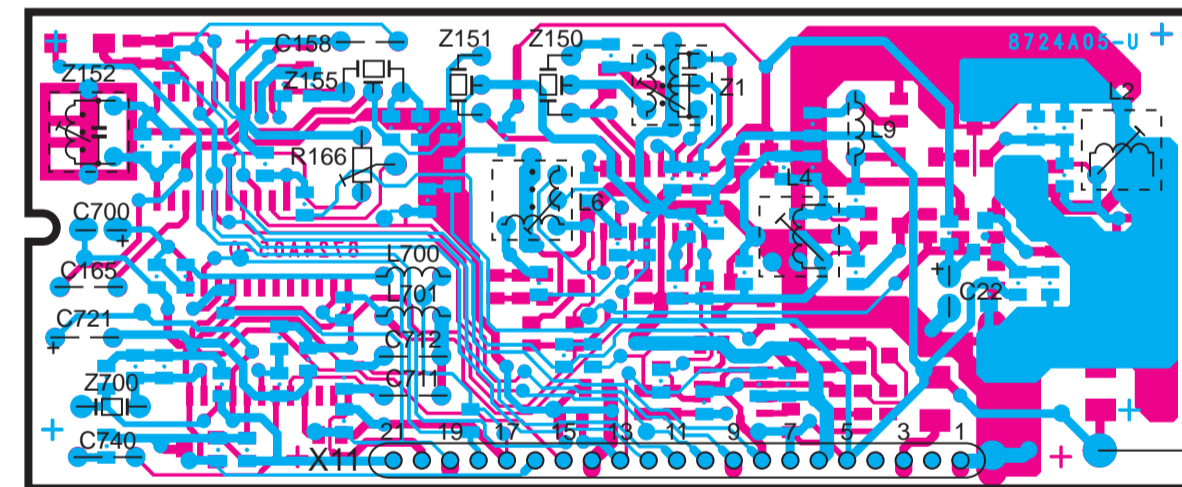

- X11**
- 1 = HF_GND
 - 2 = N.C.
 - 3 = HF
 - 4 = N.C.
 - 5 = U81
 - 6 = GND
 - 7 = QB_MULTIPATH
 - 8 = UREF
 - 9 = UF_UNBEW.
 - 10 = NF_FM
 - 11 = UF_FM
 - 12 = SL_STOP_FM
 - 13 = EIN/AUS_MULTI
 - 14 = GND (FM)
 - 15 = GND (PLL)
 - 16 = DU_AM
 - 17 = USA
 - 18 = CLK_PLL
 - 19 = DATA_PLL
 - 20 = AM-OSZ.
 - 21 = U10

PL 8724 A5

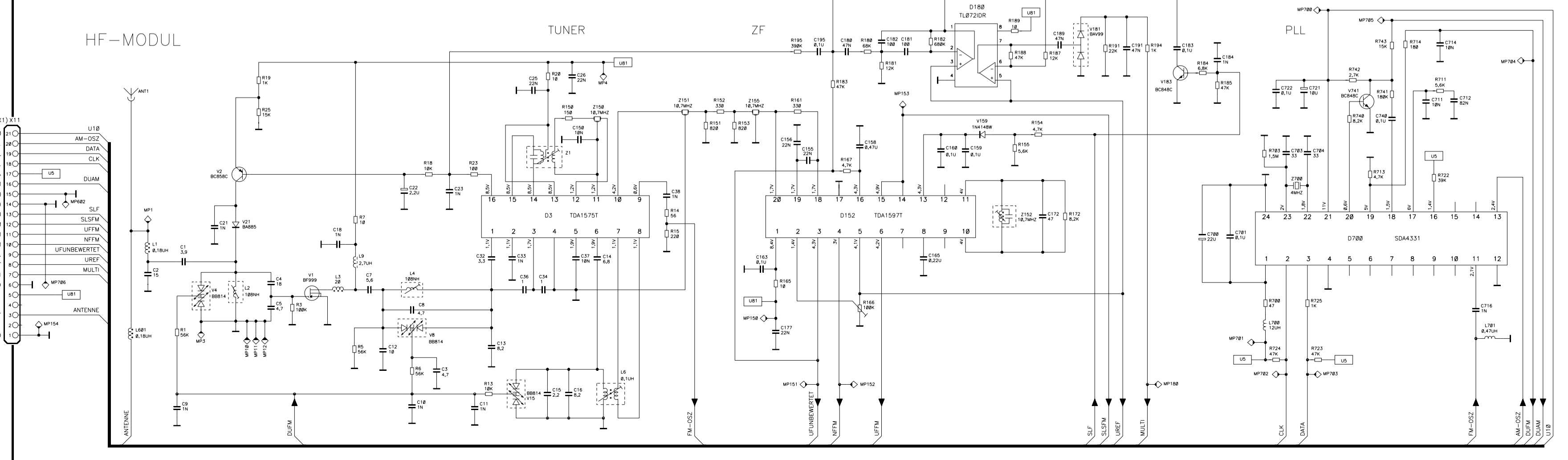

ANSCHLUSSPLATTE
CONNECTOR BOARD

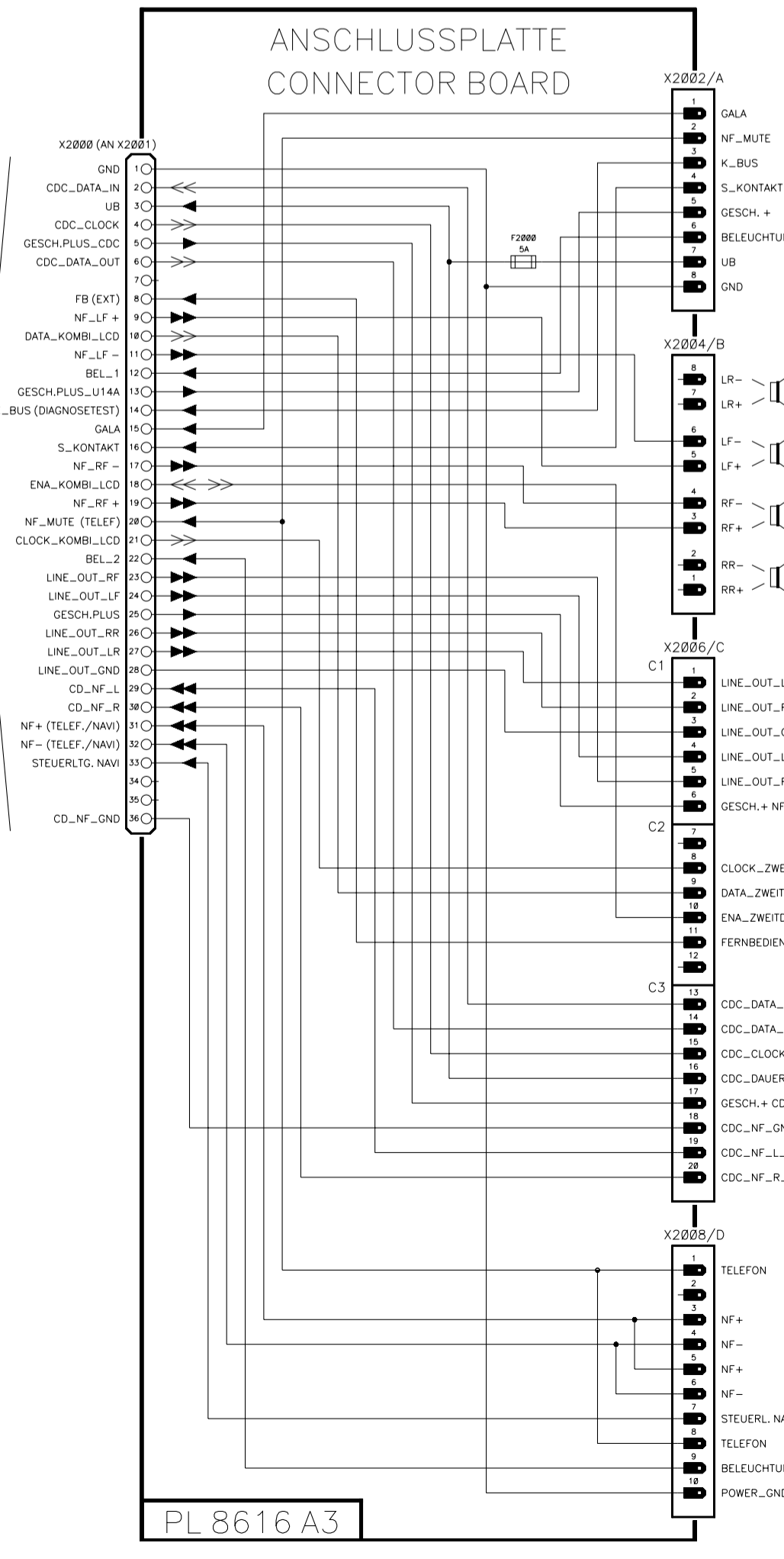

BLAUPUNKT AUTORADIO

- Audi Chorus**
7 646 243 380
- Audi Chorus A8**
7 647 243 380
- Audi Concert**
7 646 248 380
- Audi Concert A8**
7 647 248 380
- Audi Concert Navi**
7 647 249 380

8 622 401 339 BN-WG 08/97

Schaltbild • Circuit diagram • Schema du poste • Esquema del aparato

Anschlußplatte
Connector board
PL 8616 A03

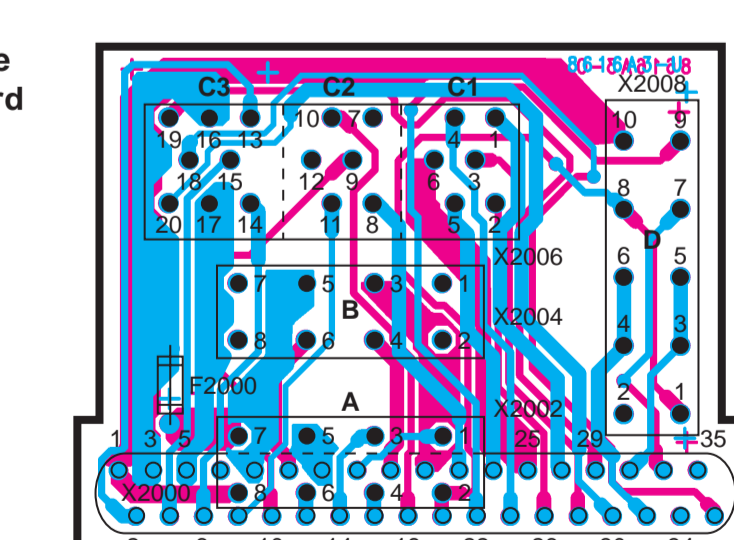

- X2000**
- 1 = GND
 - 2 = CDC_DATA_IN
 - 3 = UB
 - 4 = CDC_CLOCK
 - 5 = GESCH.+ CDC
 - 6 = CDC_DATA_OUT
 - 7 = N.C.
 - 8 = NF_MUTE (TEL)
 - 9 = NF_LF +
 - 10 = DA_KOMBI_LCD
 - 11 = NF_LF -
 - 12 = BEL_1
 - 13 = GESCH.+ U14A
 - 14 = K_BUS (DIAGN.)
 - 15 = GALA
 - 16 = S_KONTAKT
 - 17 = NF_RF -
 - 18 = ENA_KOMBI_LCD
 - 19 = NF_RF +
 - 20 = NF_MUTE (TEL)
 - 21 = CLK_KOMBI_LCD
 - 22 = BEL_2
 - 23 = LINE_OUT_RF
 - 24 = LINE_OUT_LF
 - 25 = GESCH.+
 - 26 = LINE_OUT_RR
 - 27 = LINE_OUT_LR
 - 28 = LINE_OUT_GND
 - 29 = CD_NF_L
 - 30 = CD_NF_R
 - 31 = NF+(TEL,NAVI)
 - 32 = NF-(TEL,NAVI)
 - 33 = STEUERL. NAVI
 - 34 =
 - 35 =
 - 36 = CD_NF_GND

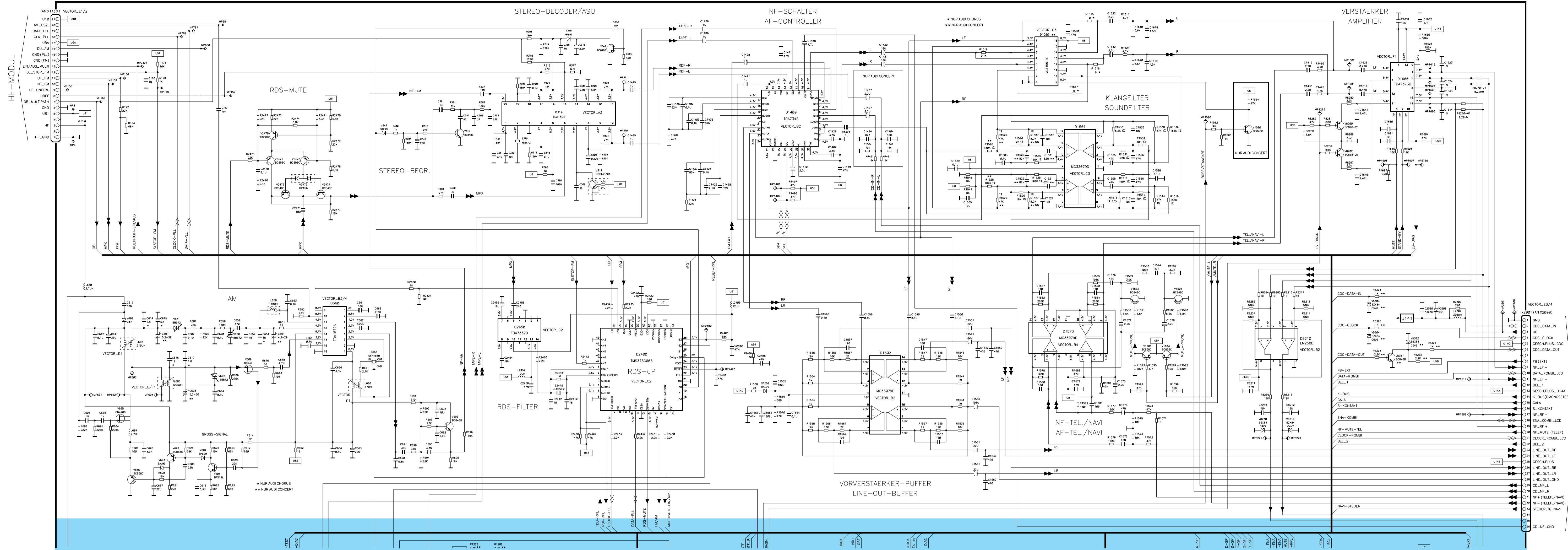

ANSCHLUSSPLATE

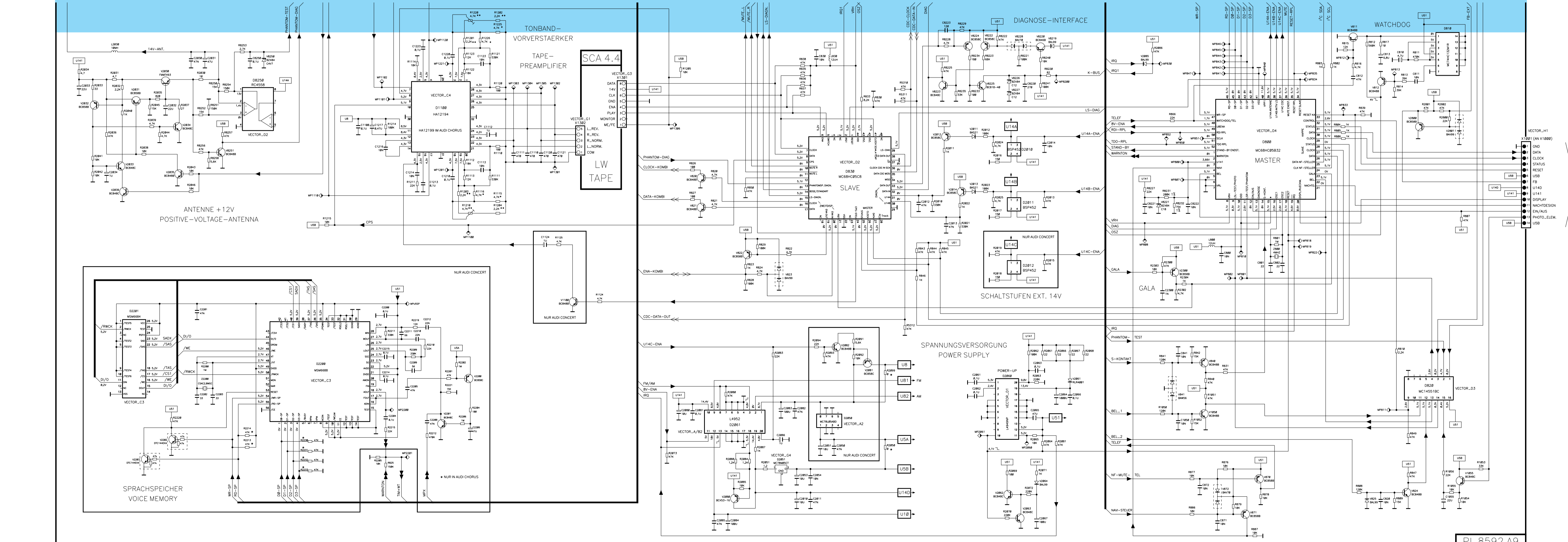

SCHALTERPLATE