



Website:<http://ca.lge.com>

Installation Manual

Electric Range

LSC5622W / LSB5611S / LST5601S / LSC5633W
LSC5674W / LSC5683W / LSB5682S / LST5651S

Please read these instructions thoroughly before installing and operating the range.

P/No.: MFL55646201

1 BEFORE YOU BEGIN

Remove all tape and packing materials before using the range. Dispose all plastic bags after unpacking the range. Never allow children to play with packing materials.

IMPORTANT SAFETY INSTRUCTIONS

Read and follow all instructions before using your oven to prevent the risk of fire, electric shock, injury to person, or damage when using the range. This guide don't cover all possible conditions that may occur. For further assistance contact your service agent or manufacturer.



This is the safety alert symbol. This symbol alerts you to potential hazards that can kill or hurt you and others. All safety messages will follow the safety alert symbol and either the word "WARNING" or "CAUTION". These word means :

**WARNING**

This symbol will alert you to hazards or unsafe practices which could cause serious bodily harm or death.

**CAUTION**

This symbol will alert you to hazards or unsafe practices which could cause bodily injury or property damage.

**WARNING**

- **The information in this manual should be followed exactly.**

- A fire or electrical shock may result causing property damage, perasonal injury or death.

- **DO NOT step or sit on the door. Install the Anti-Tip Bracket packed with range.**

- The range could be tipped and injury might result from spilled hot liquid, food, or the range itself.

- If the range is pulled away from the wall for cleaning, service, or any other reason, ensure that the Anti-Tip Device is properly reengaged when the range is pushed back against the wall.

- **New branch-circuit installations (1996 NEC), mobile homes, recreational vehicles, and installations where local codes do not allow grounding through neutral require a 4-conductor UL listed range cord or 4 wire conduit connection.**

- **The middle (neutral or ground) wire of the power cord or 3-wire conduit has to be connected to the middle post of the main terminal block. The remaining two wires of the power cord or conduit have to be connected to the outside posts of the main terminal connection block.**

- Failure to do can result in severe personal injury, death or electrical shock.

- **Only a 4-conductor power-supply cord kit rated 120/240 volts, 50 amperes and marked for use with ranges with closed-loop connectors, open-end spade lugs with upturned ends shall be used. The middle (neutral) wire of the power cord or 4-wire conduit has to be connected to the middle post of the main terminal block. Other two wires of the power cord or conduit have to be connected to the outside posts of the main terminal connection block. The 4th ground wire must be connected to the frame of the range with the ground screw.**

- Failure to do can result in severe personal injury, death or electrical shock.

**CAUTION**

- **Make sure that the wall covering, countertop and cabinets around the range can withstand the heat (up to 194°F) generated by the range.**

- Discoloration, delamination or melting may occur.

- This range has been designed to comply with the maximum allowable wood cabinet temperatures of 194°F.

- **Cabinet storage space located above the surface units should be avoided.**

- The risk of burns or fire by reaching over heated surface units can be eliminated.

- **Install a range hood that projects horizontally a minimum of 5 inches beyond the bottom of the cabinets If cabinet storage is to be provided.**

- The risk can be reduced.

⚠ WARNING

- The information in this manual should be followed exactly.
- A fire or electrical shock may result causing property damage, personal injury or death.

⚠ WARNING

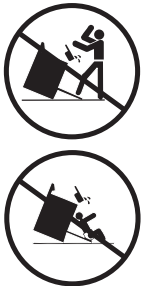

- **DO NOT step or sit on the door. Install the Anti-Tip Bracket packed with range.**
- The range could be tipped and injury might result from spilled hot liquid, food, or the range itself.
- If the range is pulled away from the wall for cleaning, service, or any other reason, ensure that the Anti-Tip Device is properly reengaged when the range is pushed back against the wall.

NOTE

- Read all instructions contained in these installation instructions before installing range.
- Remove all packing materials from the oven compartments before connecting the electrical supply to the range.
- Observe all governing codes and ordinances.
- Be sure to leave these instructions with the consumer.

NOTE

Keep these instructions with your owner's manual for future reference.

- As when using any appliance generating heat, there are certain safety precautions you should follow.
- Be sure your range is installed and grounded properly by a qualified installer or service technician.
- Make sure the wall coverings around the range can withstand the heat generated by the range.
- To eliminate the need to reach over the surface elements, cabinet storage space above the elements should be avoided.

PREPARE TO INSTALL THE RANGE

TOOLS NEEDED



Phillips Screwdriver



Flat-blade Screwdriver

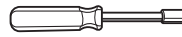

5/16" Nut Driver

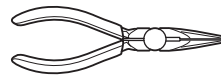

Pliers



Level



Adjustable Wrench



Drill

PARTS PROVIDED

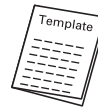

Template

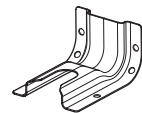

Anti-Tip Bracket Kit

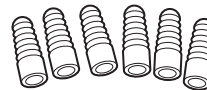

Anchor Sleeves



Lag Bolts

(For Anti-Tip Bracket Mounted on Concrete Floors and Walls)

PARTS NOT PROVIDED



(UL Approved 40 or 50 AMP)
4-Wire Cord OR 3-Wire Cord

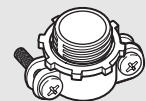

Strain Relief
(For Conduit Installations Only)

2 INSTALLATION DRAWINGS

SAVE FOR THE USE OF THE LOCAL ELECTRICAL INSPECTOR.

CLEARANCES AND DIMENSIONS (FIG. 1)

To install range refer to the following FIG. 1.

For installation in CANADA, a Free-standing range is not to be installed closer than 12mm from any adjacent surface.

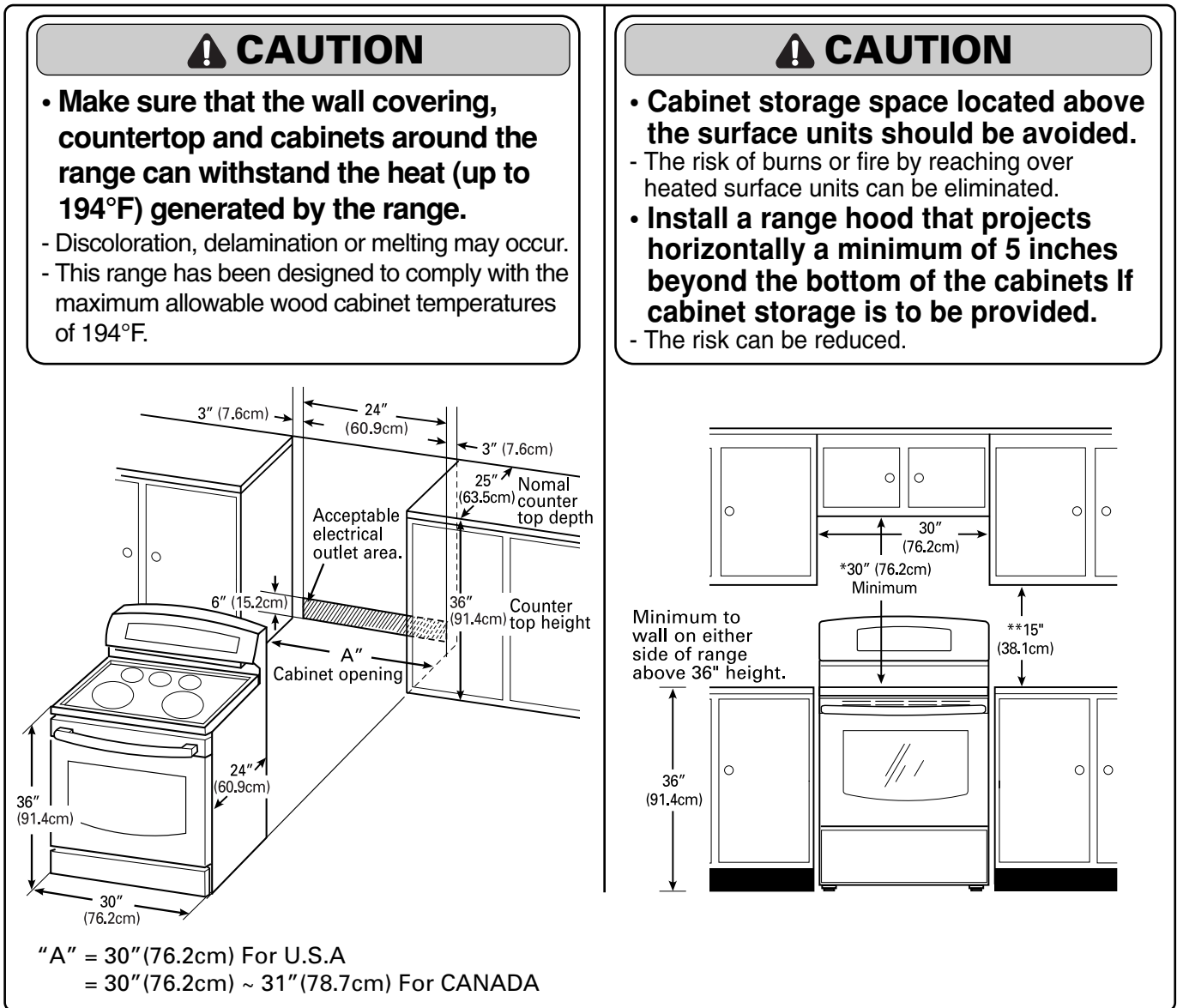

FIG. 1

FIG. 2

MINIMUM DIMENSIONS (FIG. 2)

* 30" (76.2cm) minimum clearance between the top of the cooking surface and the bottom of an unprotected wood or metal cabinet; or 24" (60.9cm) minimum when bottom of wood or metal cabinet is protected by not less than 1/4" (6.4cm) flame retardant millboard covered with not less than no. 28 MSG sheet steel, 0.015" (0.381mm) stainless steel, 0.024" (0.610mm) aluminum or 0.020" (0.508mm) copper.

** 15" (38.1cm) minimum between countertop and adjacent cabinet bottom.

3 ELECTRICAL CONNECTION REQUIREMENTS

The range must be installed in accordance with Local and Canadian Electrical Codes (latest edition). See rating plate for total connected Amp rating. This model was shipped direct from the factory with Service cord attached. There are no range connections necessary.

Note: Cord replacement

Only a range cord rated at 40 amps with 120/240 minimum volt range is required. If a 50 amp range cord is used, it should be marked for use with 1 3/8" diameter connection openings.

4 ANTI-TIP DEVICE INSTALLATION

⚠ WARNING



• **DO NOT step or sit on the door. Install the Anti-Tip Bracket packed with range.**

- The range could be tipped and injury might result from spilled hot liquid, food, or the range itself.
- If the range is pulled away from the wall for cleaning, service, or any other reason, ensure that the Anti-Tip Device is properly reengaged when the range is pushed back against the wall.

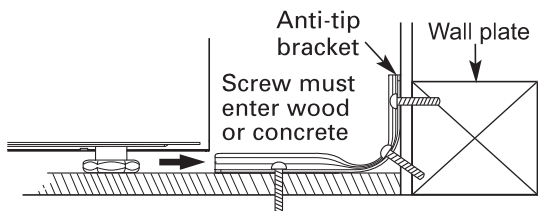

1. Locate the bracket using the template

An Anti-tip bracket is packaged with template. The instructions include necessary information to complete the installation. Read and follow range installation instruction sheet (template).

2. Level the range

Level the range by adjusting the leveling legs with a wrench.

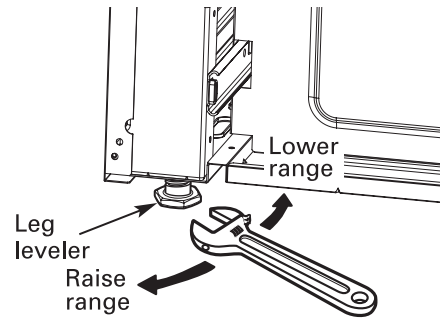

Use a spirit level to check your adjustments. Place the level diagonally on the oven rack, and check each direction for level.

First check direction ①.

After check direction ②.

If the spirit level doesn't show level on the rack, adjust the leveling legs with a wrench.

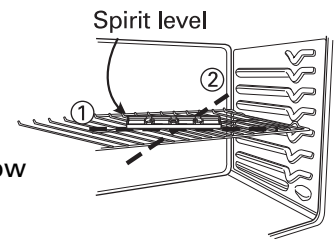

5 FINAL INSTALLATION

- Move range close enough to the opening to plug into the receptacle.
- Slide range into position insuring that the left back leg slides under the anti-tip bracket. Range will sit 0" away from the back wall when properly installed.
- Carefully tip range forward to insure that the anti-tip bracket engages the range back brace and prevents tip-over.
- Turn on electrical power. Check range for proper operation as described in owner's manual.

MEMO