

Bang & Olufsen

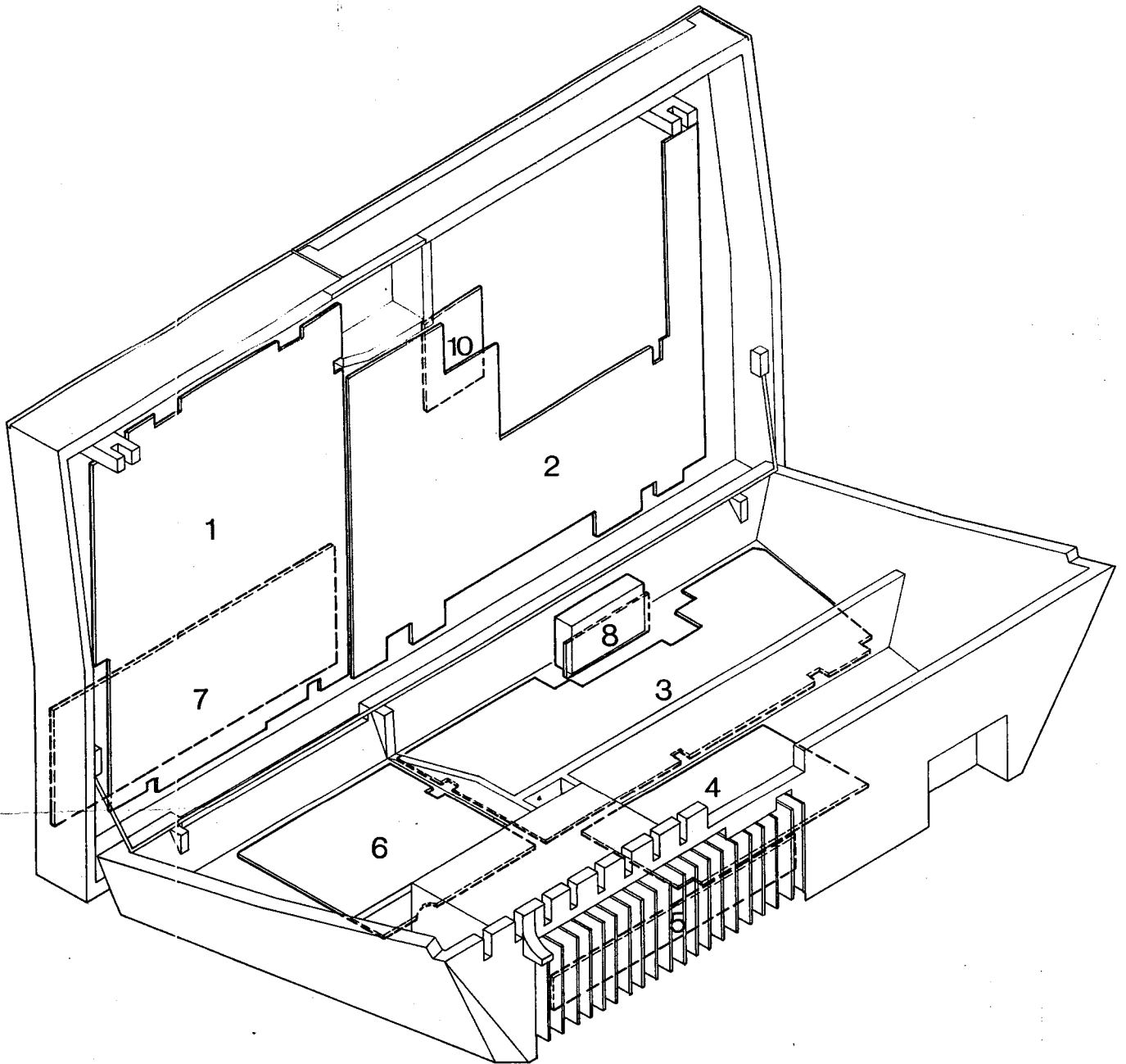

BEOCORD 8000

Type 4821, 4822, 4823, 4824, 4825, 4826

01-80 3534161

EXPLANATION TO DIAGRAM

The wire connections have been gathered into »bundles« in the diagram. The individual wire is provided with codes indicating where they lead to.

INTERNAL CONNECTION ON A DIAGRAM PAGE

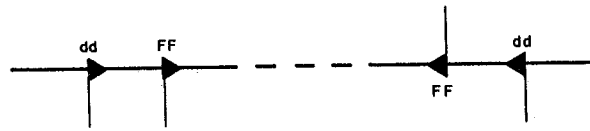

indicating by two identical letters (capital or small).

CONNECTION TO ANOTHER DIAGRAM PAGE

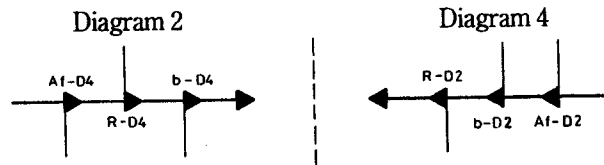

indicated by a letter (capital or small) and a diagram (D) number or by a small and a capital letter together with a diagram (D) number.

GROUND SYMBOLS

Two different ground symbols are used in the set.

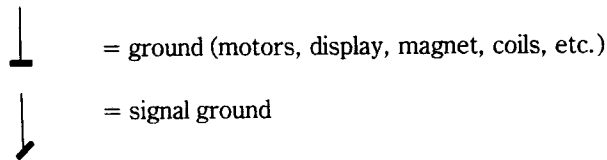

Signal voltages must be measured in relation to signal ground in order to obtain correct result.

CO-ORDINATE NUMBERS

The biggest PC boards are provided with co-ordinate systems. The components on these PC boards are provided with a co-ordinate number on the diagram (smaller printing type than the position numbers) indicating in which co-ordinate they are placed on the PC board.

ERLÄUTERUNGEN ZUM SCHALTBILD

Die Leitungsverbindungen sind im Schaltbild in »Bündeln« gesammelt. Die einzelnen Leitungen sind mit Coden versehen, die angeben, wohin die Leitungen führen.

INTERNE VERBINDUNG AUF EINER SCHALTBILDSEITE

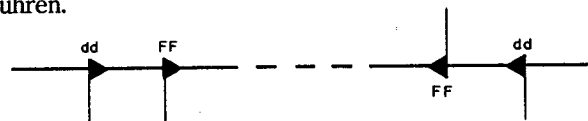

sind mit zwei gleichen Buchstaben (gross oder klein) angegeben.

VERBINDUNG ZU EINER ANDEREN SCHALTBILDSEITE

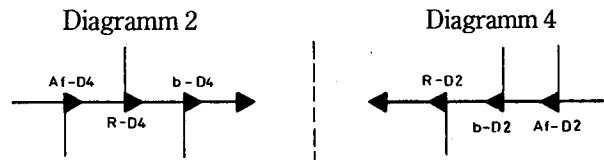

sind mit einem Buchstaben (gross oder klein) und einem Schaltbild (D) Nummer oder mit einem kleinen und einem grossen Buchstaben zusammen mit einer Schaltbild (D) Nummer angegeben.

MASSE SYMBOLE

Im Gerät werden 2 verschiedene Masse-Symbole verwandt.

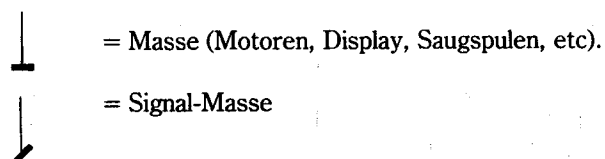

Signal-Spannungen müssen im Verhältnis zu Signal Masse gemessen werden, um ein korrektes Ergebnis zu erhalten.

KOORDINATENNUMMERN

Die grössten Printplatten sind mit einem Koordinatensystem versehen. Die Komponenten auf diesen Printplatten sind im Schaltbild mit einer Koordinatennummer (kleinerem Schrifttyp als der Positionsnummer) versehen, die erklärt in welcher Koordinate auf der Printplatte sie angebracht sind.

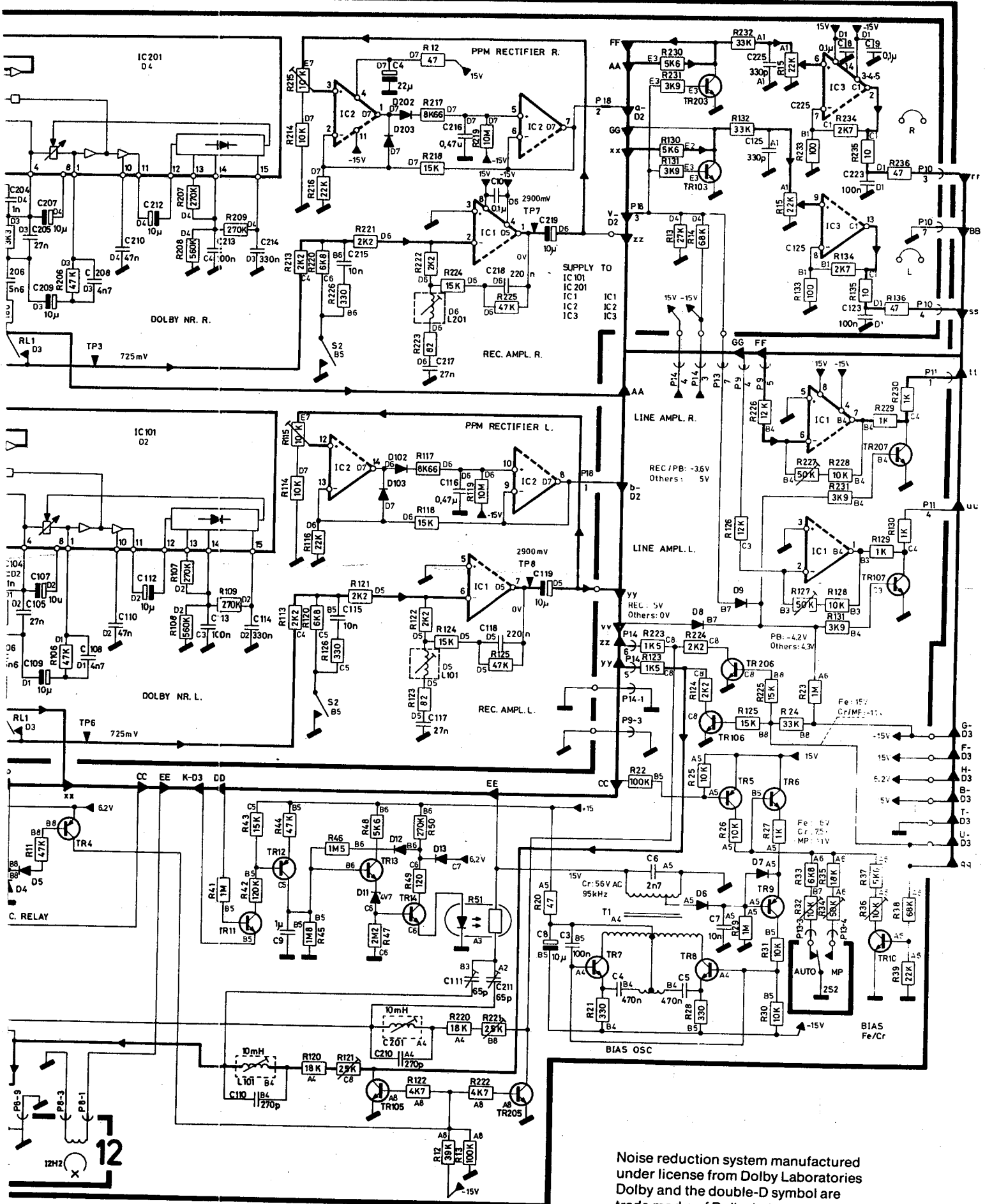

Noise reduction system manufactured under license from Dolby Laboratories. Dolby and the double-D symbol are trade marks of Dolby Laboratories.

DIAGRAM 2

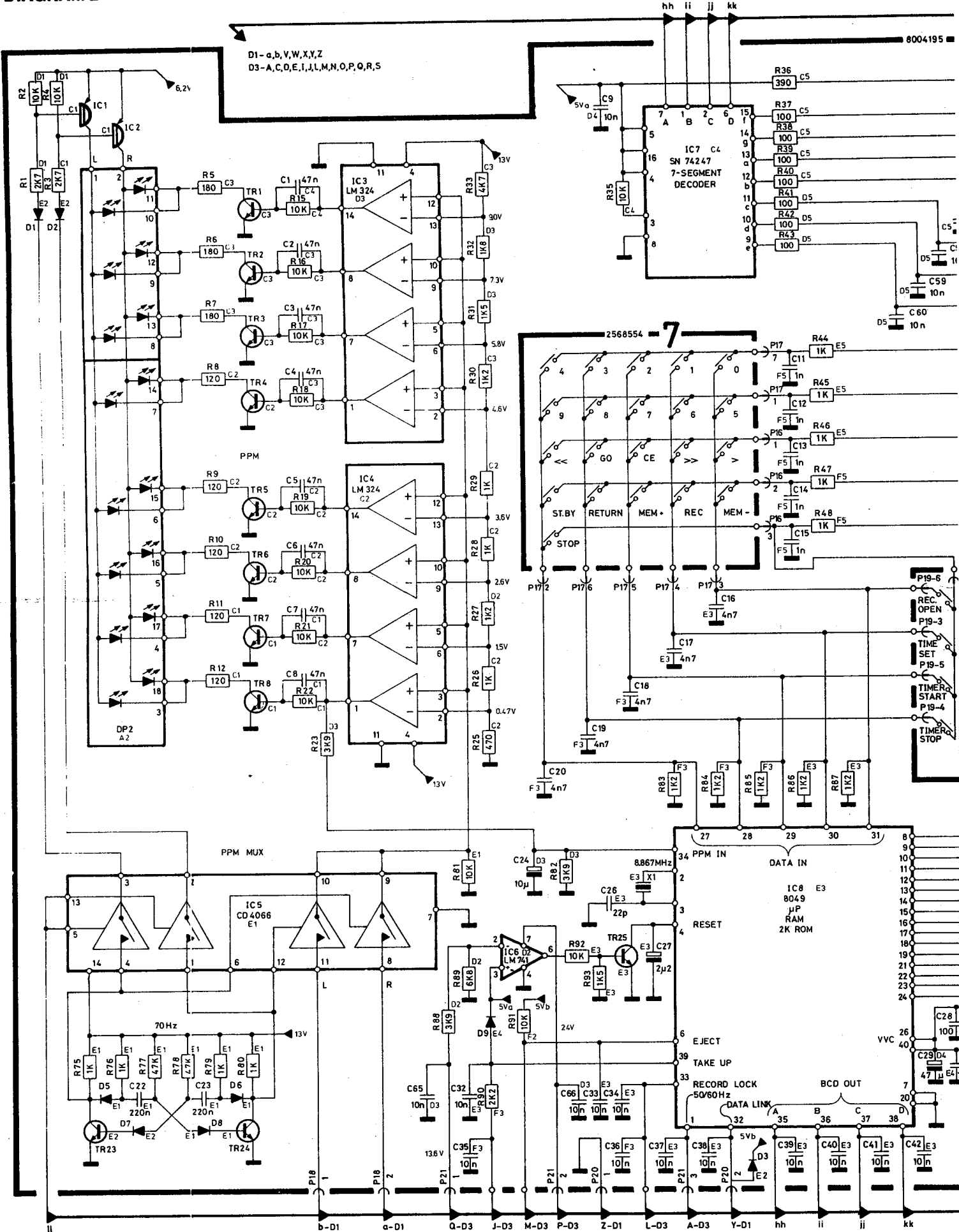

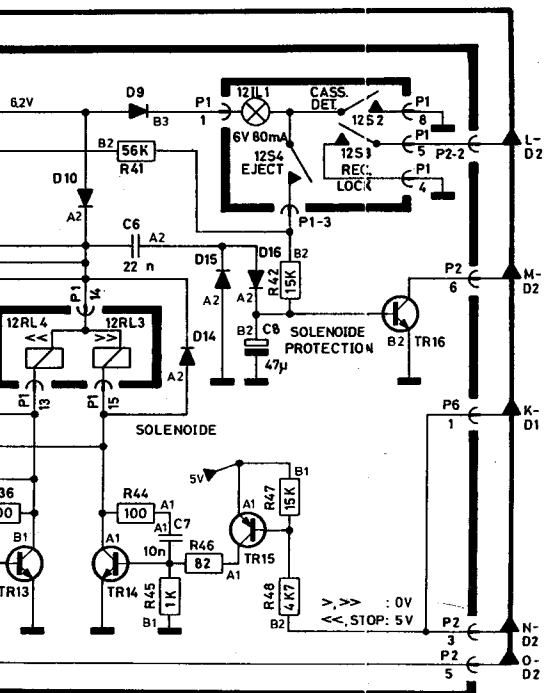

Switches:

- 12S1 Fe₂O₃ ON, CrO₂ OFF.
- 12S2 With cass. ON, without OFF.
- 12S3 Rec. ON, Rec lock OFF.
- 12S4 Play ON, Press eject OFF.

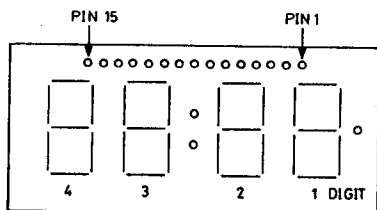

- PIN ASSIGNMENT (BOTTOM VIEW)**
- 1 COMMON CATHODE (POINTS)
 - 2 LOWER POINT ANODE
 - 3 UPPER POINT ANODE
 - 4 -POINT ANODE
 - 5 DIGIT 1 ANODE
 - 6 DIGIT 2 ANODE
 - 7 DIGIT 3 ANODE
 - 8 DIGIT 4 ANODE
 - 9 SEG. fCATHODE
 - 10 SEG. gCATHODE
 - 11 SEG. aCATHODE
 - 12 SEG. bCATHODE
 - 13 SEG. cCATHODE
 - 14 SEG. dCATHODE
 - 15 SEG. eCATHODE

PIN	CONDITIONS			FUNCTION	RESULTS							
	11C8	11C8	11C8		11C9							
	4	33	6		24	25	26	27	28	37	30	29
	1			STAND BY	1	1	1	0	0	1		
	1	1	1	REC OPEN			1		0	0	0	1
	1	1	1	RECORD	0	0	0	1	1	0	0	0
	1			STOP	1	1	1	0	0	0		1
	1		1	»	0	1	1	0	0	0		1
	1		1	«	1	0	1	0	0	0		1
	1		1	>	0	0	1	1	0	0		1
	1	1	1	REC PAUSE	1	1	0	1	1	0	0	0

DECIMAL ON DISPLAY	INPUTS				OUTPUTS						
	D	C	B	A	a	b	c	d	e	f	g
0	0	0	0	0	0	0	0	0	0	0	1
1	0	0	0	1	1	0	0	1	1	1	1
2	0	0	1	0	0	0	1	0	0	1	0
3	0	0	1	1	0	0	0	0	1	1	0
4	0	1	0	0	1	0	0	1	1	0	0
5	0	1	0	1	0	1	0	0	1	0	0
6	0	1	1	0	0	1	0	0	0	0	0
7	0	1	1	1	0	0	0	1	1	1	1
8	1	0	0	0	0	0	0	0	0	0	0
9	1	0	0	1	0	0	0	0	1	0	0
∩	1	0	1	1	1	1	0	0	1	1	0
C	1	0	1	0	1	1	1	0	0	1	0
U	1	1	0	0	1	0	1	1	1	0	0
E	1	1	0	1	0	1	1	0	1	0	0

EXPLANATION TO DIAGRAM

The wire connections have been gathered into »bundles« in the diagram. The individual wire is provided with codes indicating where they lead to.

INTERNAL CONNECTION ON A DIAGRAM PAGE

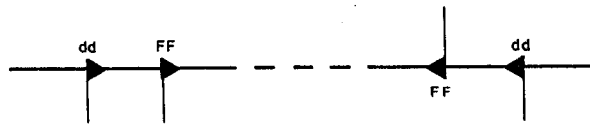

indicating by two identical letters (capital or small).

CONNECTION TO ANOTHER DIAGRAM PAGE

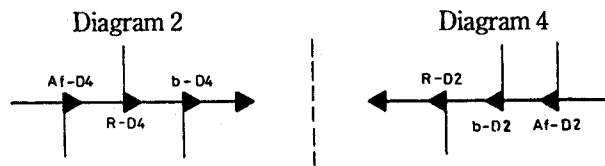

indicated by a letter (capital or small) and a diagram (D) number or by a small and a capital letter together with a diagram (D) number.

GROUND SYMBOLS

Two different ground symbols are used in the set.

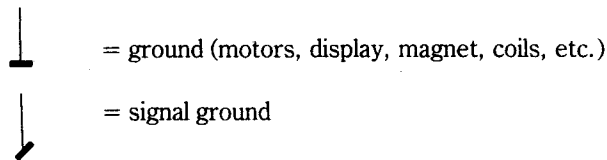

Signal voltages must be measured in relation to signal ground in order to obtain correct result.

CO-ORDINATE NUMBERS

The biggest PC boards are provided with co-ordinate systems. The components on these PC boards are provided with a co-ordinate number on the diagram (smaller printing type than the position numbers) indicating in which co-ordinate they are placed on the PC board.

ERLÄUTERUNGEN ZUM SCHALTBILD

Die Leitungsverbindungen sind im Schaltbild in »Bündeln« gesammelt. Die einzelnen Leitungen sind mit Coden versehen, die angeben, wohin die Leitungen führen.

INTERNE VERBINDUNG AUF EINER SCHALTBILDSEITE

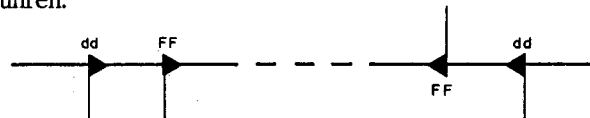

sind mit zwei gleichen Buchstaben (gross oder klein) angegeben.

VERBINDUNG ZU EINER ANDEREN SCHALTBILDSEITE

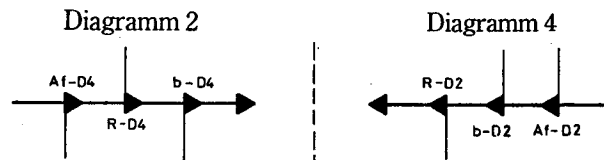

sind mit einem Buchstaben (gross oder klein) und einem Schaltbild (D) Nummer oder mit einem kleinen und einem grossen Buchstaben zusammen mit einer Schaltbild (D) Nummer angegeben.

MASSE SYMBOLE

Im Gerät werden 2 verschiedene Masse-Symbole verwandt.

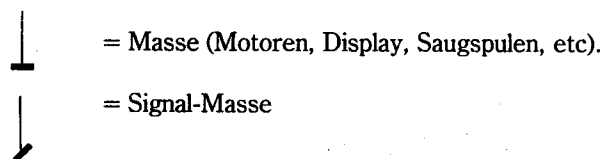

Signal-Spannungen müssen im Verhältnis zu Signal Masse gemessen werden, um ein korrektes Ergebnis zu erhalten.

KOORDINATENNUMMERN

Die grössten Printplatten sind mit einem Koordinatensystem versehen. Die Komponenten auf diesen Printplatten sind im Schaltbild mit einer Koordinatennummer (kleinerem Schrifttyp als der Positionsnummer) versehen, die erklärt in welcher Koordinate auf der Printplatte sie angebracht sind.

LIST OF TRANSISTORS

AND IC's

19 	20 	24 	31 	32 	101 	102 	103
105 	123 	124 					

1TR1	8320097	20	BC 547 B	1IC4
1TR2				
1TR3				1IC5
1TR4				8340209
1TR5				102
1TR6				HEF 4016
1TR7				102
1TR8				MC 4016
1TR10	8320152	20	BC 557 B	1IC6
1TR11				8340141
1TR13				103
				LM 741 CN
1TR14	8320329	20	BC 338-25/18	1IC7
				8340156
				101
				SN 74247 N
1TR15	8320152	20	BC 557 B	1IC8
				8340158
				124
				μP 8049
1TR16	8320329	20	BC 338-25/18	1IC9
				8340159
				124
				EXP. 8355
1TR17	8320152	20	BC 547 B	2TR1
				8320152
				20
				BC 557 B
1TR18	8320329	20	BC 338-25/18	2TR101/201
				8320097
				20
				BC 547 B
1TR19	8320152	20	BC 557 B	2TR102/202
				8320396
				24
				2 N 5639
				24
				MPF 4302
1TR20	8320329	20	BC 338-25/18	2TR103/203
				8320097
				20
				BC 547 B
1TR21	8320152	20	BC 557 B	2IC1
				8340195
				103
				LF 353 BN
1TR23	8320097	20	BC 547 B	2IC2
1TR24				8340205
1TR25				102
				LF 347 N
				102
				TL 084 CN
1TR26	8320152	20	BC 557 B	2IC3
1TR27				8340232
1TR28				102
				LM 378
1TR29	8320097	20	BC 547 B	2IC101/201
				8340183
				101
				LM 1011 AN
1TR30	8320152	20	BC 557 B	3TR1
				8320152
				20
				BC 557 B
1IC1	8340025	19	MPS A65	3TR2
1IC2		19	SPS 5431	8320331
				20
				BC 328-25/18
1IC3	8340157	102	LM 324	3TR3
				8320097
				20
				BC 547 B
				3TR4
				8320152
				20
				BC 557 B
				3TR5
				3TR6
				8320097
				20
				BC 547 B
				3TR7
				8320237
				20
				BC 546 B
				3TR8
				3TR9
				8320152
				20
				BC 557 B

Bang & Olufsen

3TR10	8320097	20	BC 547 B
3TR11			
3TR12	8320152	20	BC 557 B
3TR13	8320097	20	BC 547 B
3TR14			
3TR101/201	8320344	20	BC 550 B
3TR102/202	8320069	20	BC 559 B
3TR103/203	8320097	20	BC 547 B
3TR104/204	8320152	20	BC 557 B
3TR105/205	8320366	19	NPS A 16
3TR106/206			
3TR107/207	8320097	20	BC 547 B
3IC1	8340048	103	MC 1458CP1
4TR1	8320428	32	BD 438
4TR2	8320097	20	BC 547B
4TR3	8320321	19	MPS A 06
4TR4	8320152	20	BC 557 B
4TR5	8320427	32	BD 437
4TR6	8320152	20	BC 557 B
4TR7	8320097	20	BC 547 B
4TR8	8320152	20	BC 557 B
4TR9	8320097	20	BC 547 B
4TR11	8320321	19	MPS A 06
4TR12	8320331	20	BC 328-25/18
4TR13	8320441	32	BD 439
4TR14			
4TR15	8320331	20	BC 328-25/18
4TR16	8320097	20	BC 547 B
4IC1	8340207	32	BD 678
5TR1	8320369	31	BP 534
5IC1	8340208	105	UA 78 M 15
5IC2	8340240	123	UA 7915/C 123 LM 3207-15 123 MC 7915 CT
5IC3	8340212	105	MC 78 M5CT
8IC1	8340262	103	NE 5532
8IC2			

LIST OF DIODES

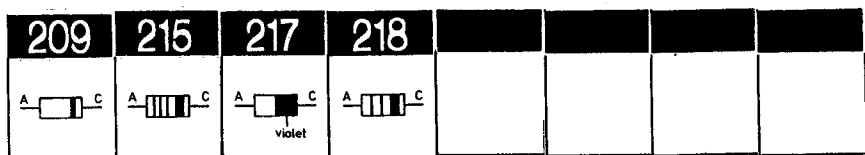

OD1	8320058	217	SFD 184
		215	1N 4148
		209	1N 4148
1D1	8300058	217	SFD 184
1D2		215	1N 4148
1D3		209	1N 4148
1D5			
1D6			
1D7			
1D8			
1D9			
1D10	8300189	218	BAV 19
		218	BA 219/TB
1D11	8300058	217	SFD 184
		215	1N 4148
		209	1N 4148
1D12	8300201	209	ZPD 6.2V5%
		209	BZX 79C6V2
		209	BZX 83C6V2
1DP1	8330028		FCS 8499
1DP2	8330014		FNA 0098
2D1	8300058	217	SFD 184
2D2		215	1N 4148
2D3		209	1N 4148
2D101/201			
2D102/202			

Bang & Olufsen

ADSKILLELSE DISASSEMBLY

Serviceposition: Skrue A løsnes
Service position: Loosen screw A

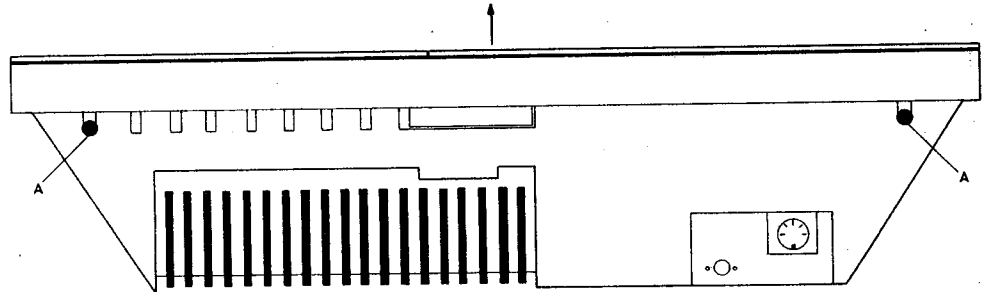

Betjeningspanel
Operating panel

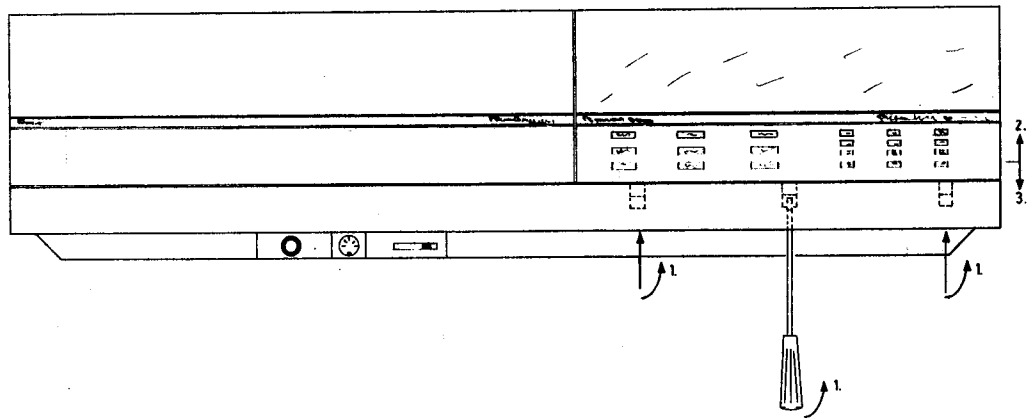

Display dæksel
Cover for display

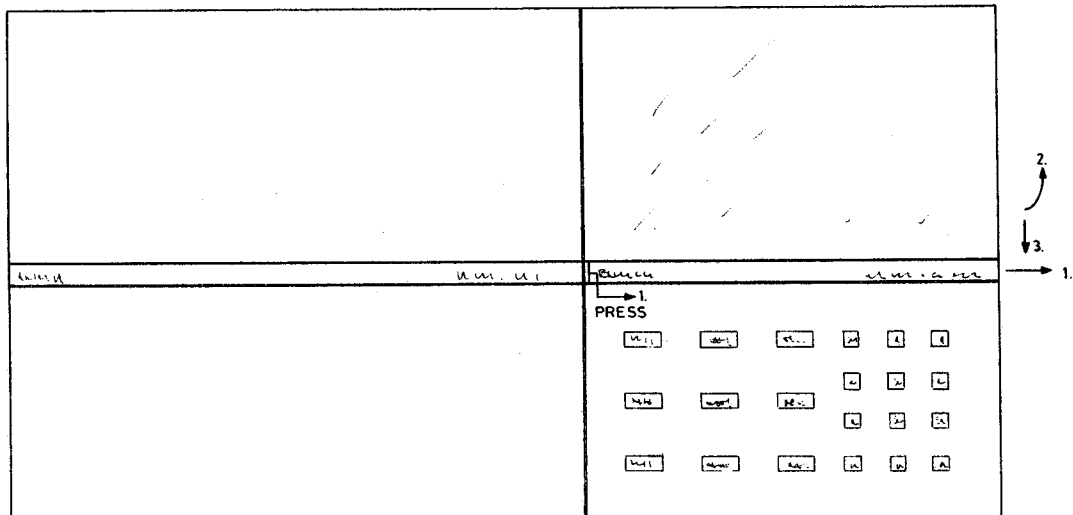

Toppanel og vippelåg
Cover and panel

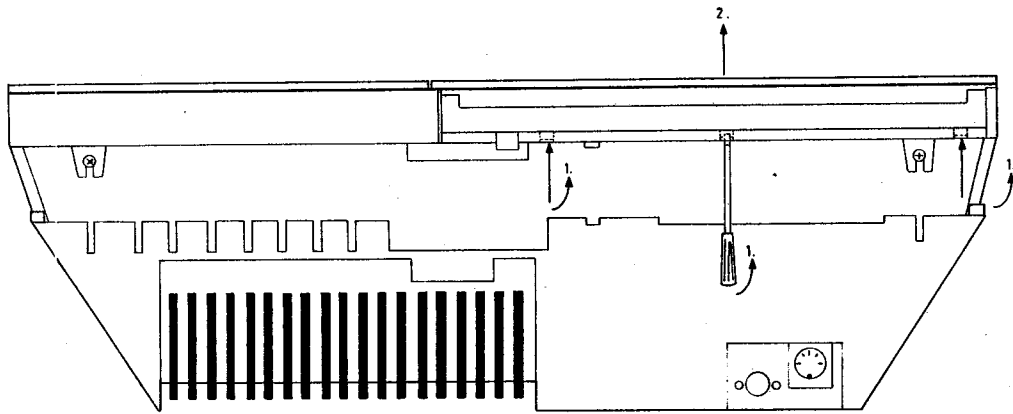

Aluminiumsdækplade
Aluminium cover

